

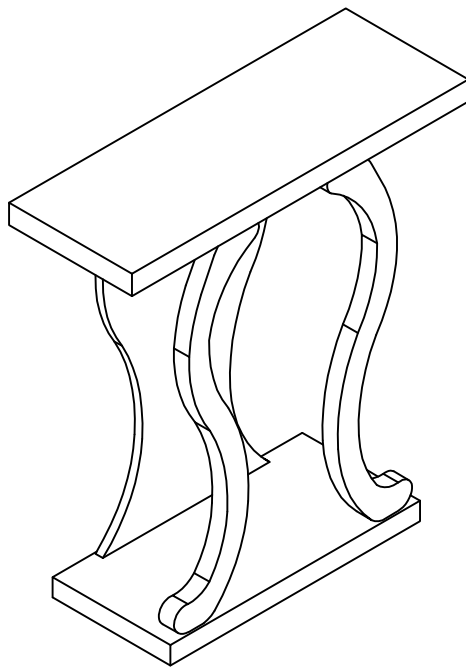









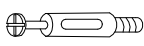





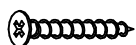

CONSOLE



Assembly instructions

We have designed our furniture with you,space the customer in mind. Our clear,space easy to follow. Step by step instructions will guide you through the project from start to finish. Feel confident that this will be a fun and rewarding project .The final product will be a quality piece of furniture that will go together smoothly and give years of enjoyment.

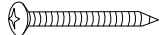
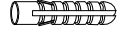
Hardware List

A  L29	B  ø15	C  ø8×25	D  M8
Cam bolt (2pcs)	Cam lock (2pcs)	Dowel (5pcs)	Jam washer & Nut (2pcs)
E  M8x70	F  ø8×16×2	G  ø4×55	H  ø45
Full Threaded Rod (2pcs)	Medium Washer (4pcs)	Screw (2pcs)	Large Sticker (2pcs)
I  ø13	J  ø16	K  M4	L  M6×65
Small sticker (2pcs)	Foot Pin (4pcs)	Allen Wrench (1pc)	Barrel Bolt (2pcs)
M  M6×15	N  ø13	O  197×5×1	P  12×12×1
Barrel Nut (2pcs)	Wrench (1pc)	ANTI-TIP Strap (1pc)	Bracket (1pc)
Q  ø4×25	R  ø5X40	S  ø8X40	T  Glue (1pc)
Small Screw (1pc)	Wall Screw (1pc)	Plastic Anchor (1pc)	Glue (1pc)
			Glue: For securing please apply to wood dowel first before inserting into panel

Please count and verify all parts before assembly.

Panel List

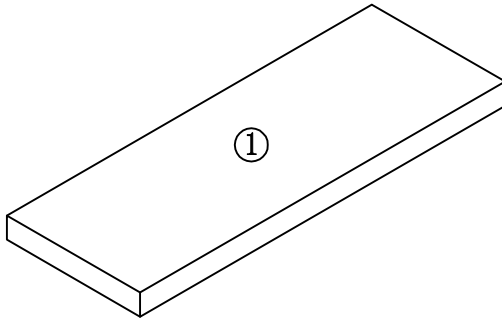

TOP PANEL(1pc)

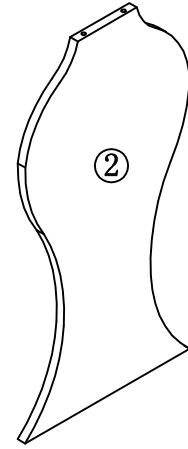

BACK PANEL(1pc)



LEFT LEG(1pc)

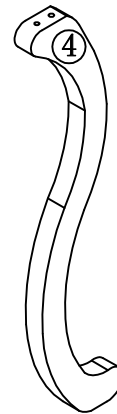

RIGHT LEG(1pc)

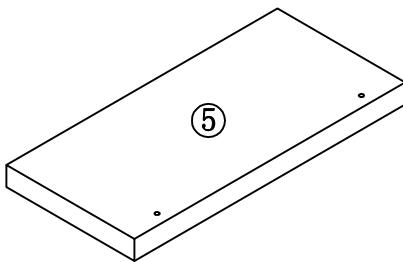

BOTTOM PANEL(1pc)

Please count and verify all parts before assembly.

Assembling the unit with camlocks and wood dowels.

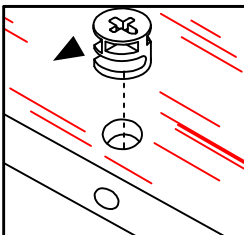
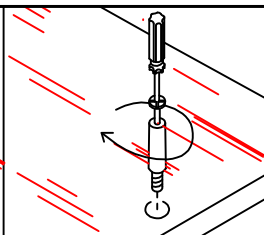
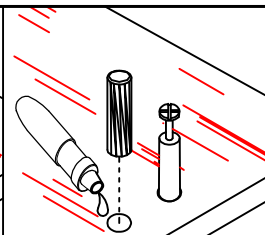
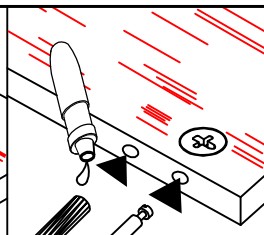
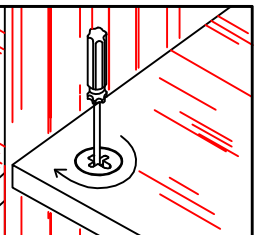
				
Insert camlock, camlock must face bolt hole	Gently screw cam bolt into the threaded anchor	lightly glue one end of wood dowel and tap into hole.	lightly glue dowel and connect to second panel by inserting dowels into holes	Gently screw the cam clockwise into locked position. Do not overtighten.

Exploded Views

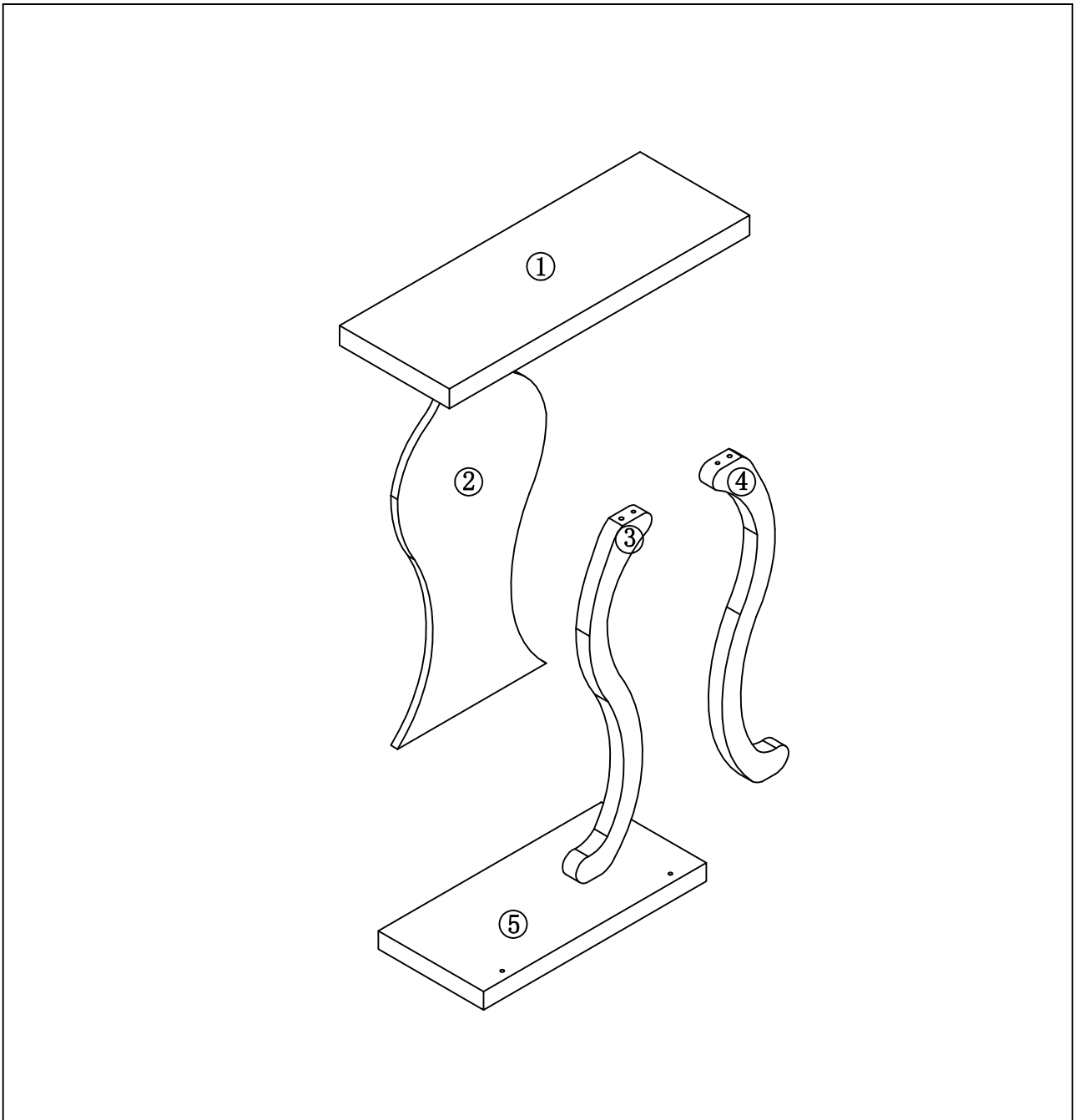

Step1

1. Insert wood dowel(C) into bottom of back panel(2).
2. Connect back panel(2) to bottom panel(5) using screws(G).

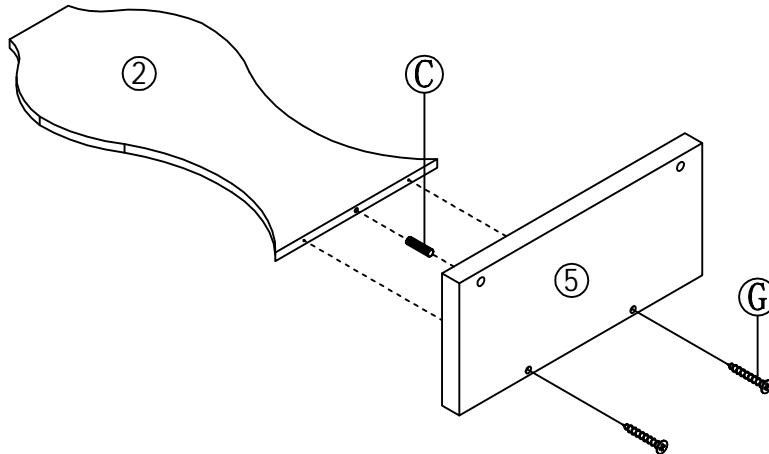
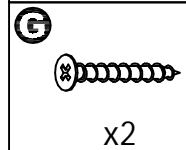
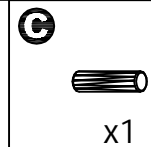

Step2

1. Insert wood dowels(C) into bottom of right leg(4) and left leg(3) as shown.
2. Insert barrel nuts(M) into back of legs (3) and (4) as shown. Make sure that hole in barrel nut faces bolt hole in bottom of legs.
3. Connect legs(3) and (4) to bottom panel(5) using barrel bolt(L), medium washer(F) and allen wrench(K).
4. Cover Barrel nuts with small stickers(I).

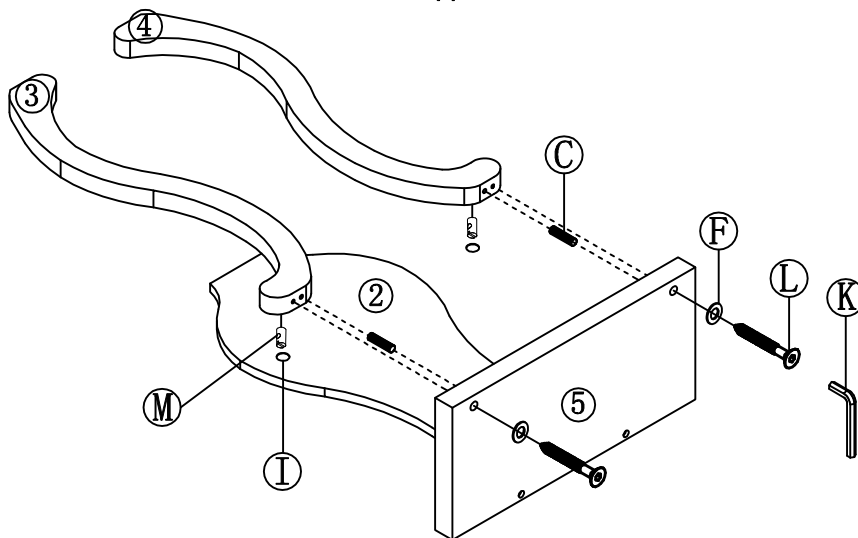
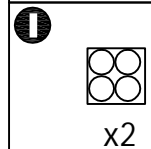
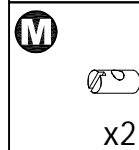
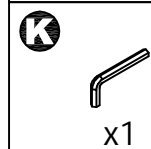
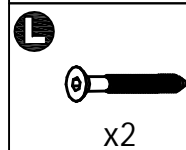
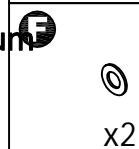
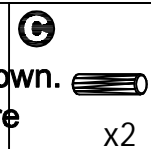

Step3

1. Gently tap foot pin(J) onto bottom of bottom

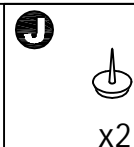
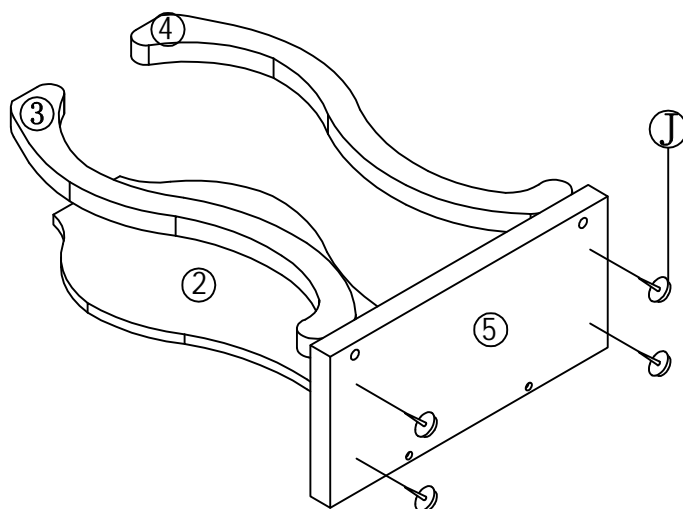

Step4

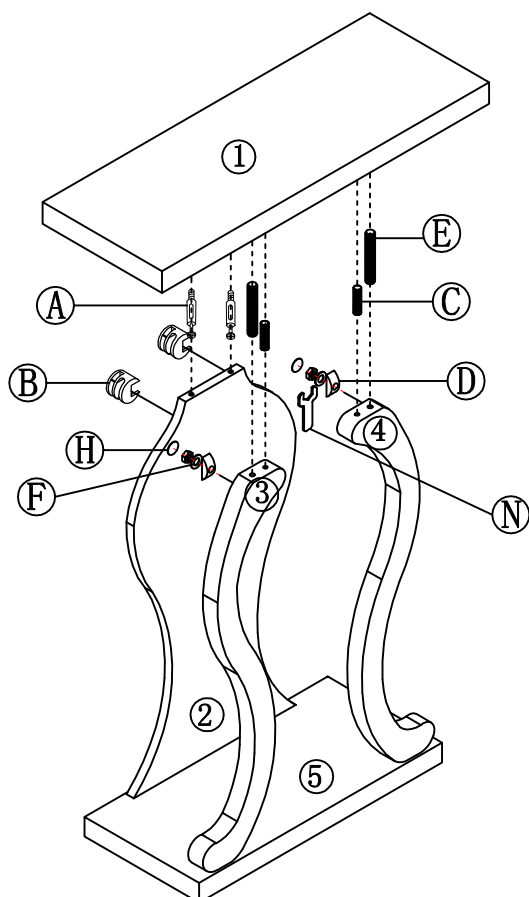

1. Screw cambolts(A) into top panel(1).
2. Screw full threaded rod(E) into top panel(1).
3. Insert camlocks(B) into back panel(2) and dowels(C) into legs(3) and (4).
4. Connect top panel(1) to assembly. Gently tighten camlocks.
5. On inside of legs(3) and (4) use jam washer and nut(D) and washer(F) on full threaded rod(E). Tighten with wrench(N).
6. Cover holes with large stickers(H).

