

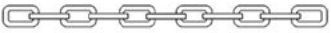















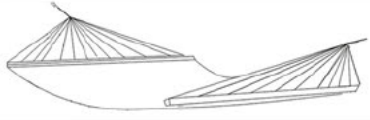







Please read these instructions and warranty information carefully before use and keep them properly for future reference.

OPERATING INSTRUCTIONS

# Part List

	Ax2		Px2
	Bx2		Qx4
	Cx2		Rx4
 <b>M10*140MM</b>	Dx 4		Sx2
	Ex12		Tx1
	Fx12		Ux2
 	Gx2		Vx2
 <b>M10*190MM</b>	Hx 4		Wx1
 <b>M10*80MM</b>	Ix2		Yx1
	Jx4		
	Kx4		
 <b>M10X120MM</b>	Lx1		
 <b>M8X50MM</b>	Mx8		
	Nx8		
 <b>M10X120MM</b>	Ox1		
 <b>M10*85MM</b>	Zx1		

# Assembly Instructions

1

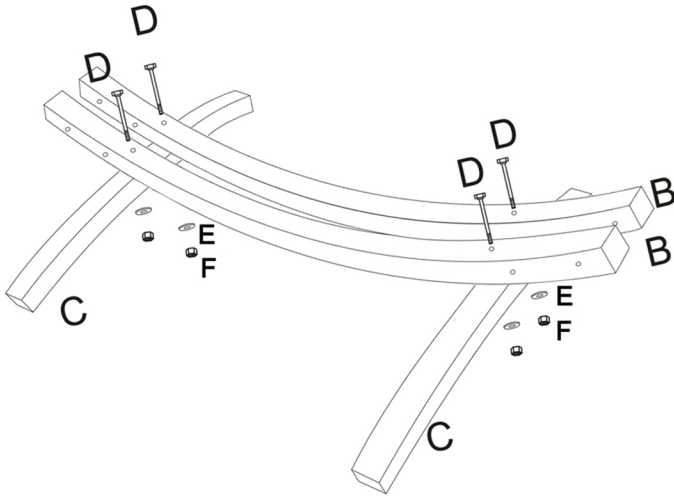

2

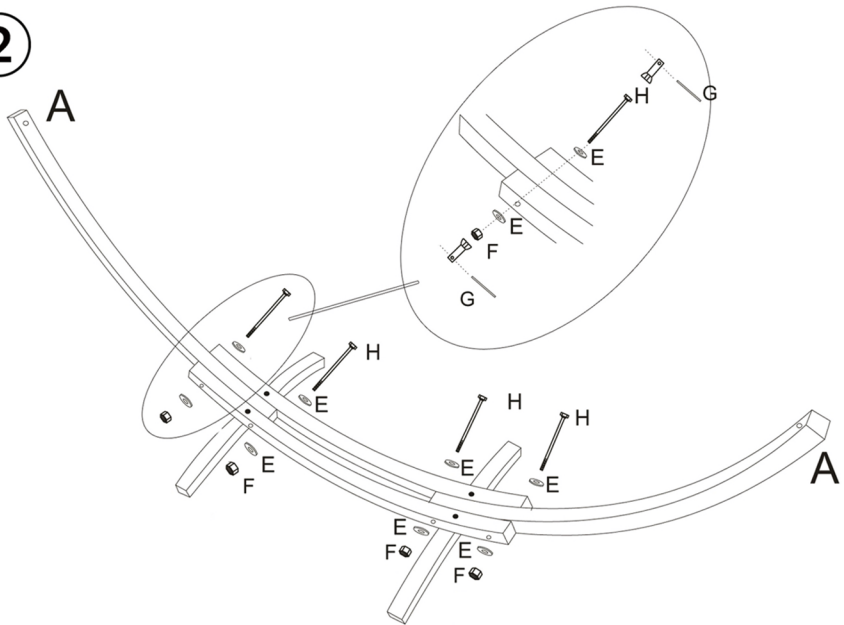

Diagrams showing bolts "D" and washers "E" for part "B" + "C". Tighten them well otherwise part "C" will crack if not secured.

# Assembly Instructions

3

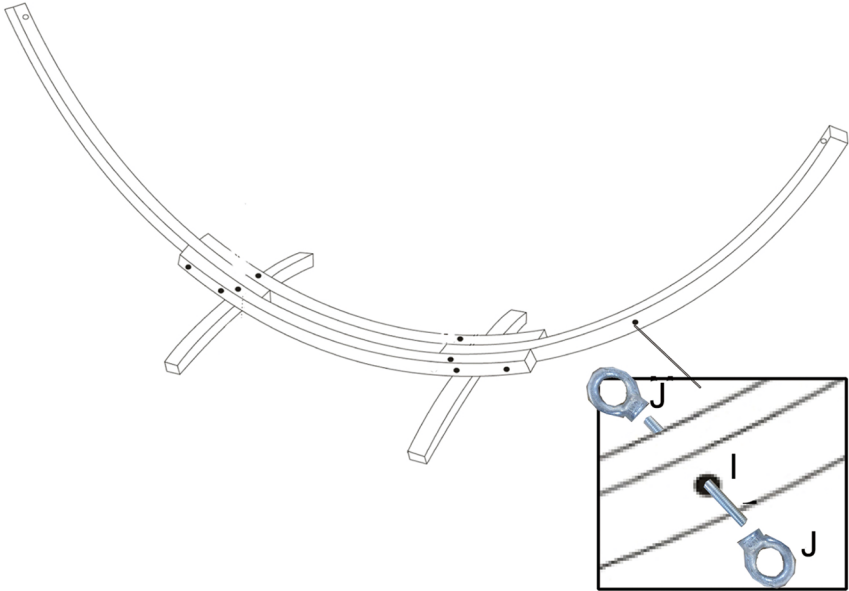

4

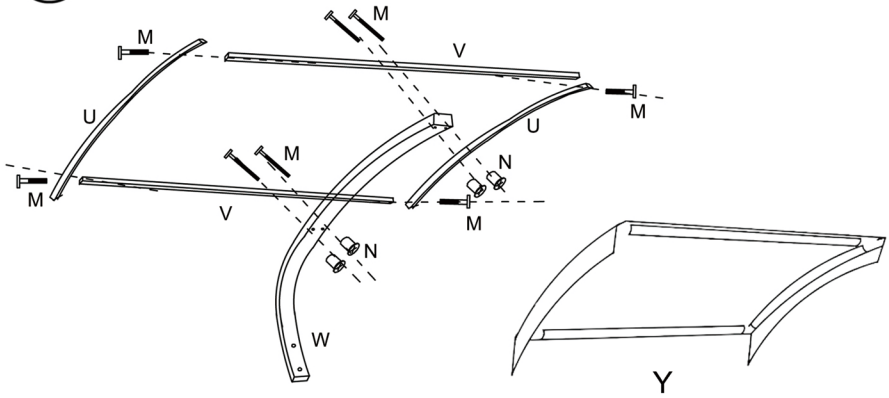

Put Part U,Part V through Part Y,then assemble these parts as picture 4.

# Assembly Instructions

5

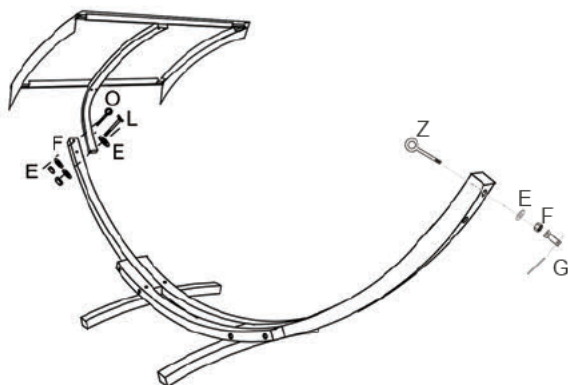

6

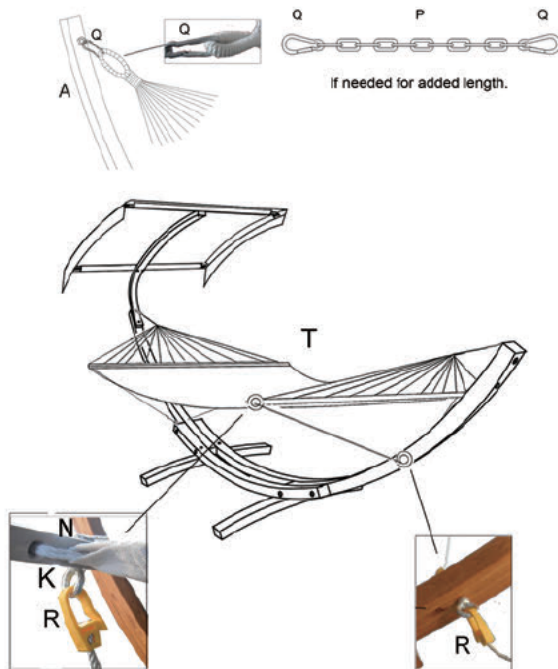

## NOTE

1. Bolts for all the steps should not be tightened all the way until all bolts are fully in place. Once all in place then tighten bolts.

otherwise the holes will

2. Two or more people for assembly.