







ASSEMBLY INSTRUCTION

DESCRIPTION : CREDENZA HUTCH

Thank you for purchasing this quality product. Be sure to check all packing material carefully for small Hardware which may have come loose inside the carton during shipment. Identify and count all Hardware and compare with the Hardware List Below.

| Parts List | | |
|------------|----------------|-------|
| No. | Description | Qty. |
| ① | Credenza Hutch | 1 Pc |
| ② | Credenza | 4 Pcs |

| Hardware List (Pack inside Rectangular Leg Table) | | | |
|--|---|---|-------|
| No. | Description | Hardware | Qty. |
| (A) | JCBC Screw $\varnothing 1/4" \times 25\text{mm}$ |  | 4 Pcs |
| (B) | Spring Washer $\varnothing 1/4"$ |  | 4 Pcs |
| (C) | Flat Washer $\varnothing 1/4" \times 19 \text{ mm} \times 2 \text{ mm}$ |  | 4 Pcs |
| (D) | Allen Key M4 |  | 1 Pc |
| (E) | Bracket |  | 1 Pcs |
| (F) | Tipping Restraint |  | Set |

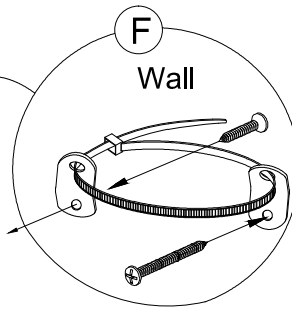
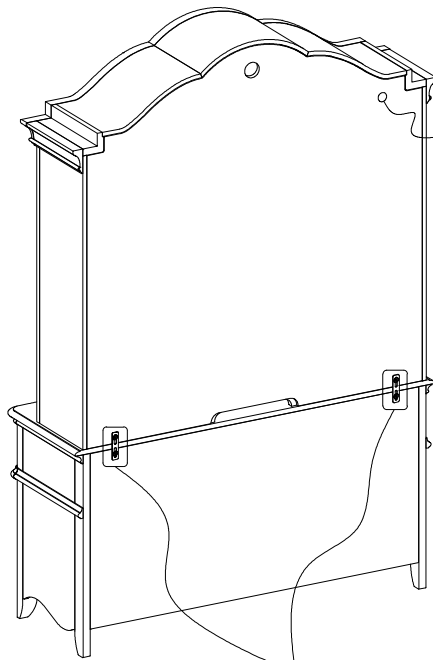

STEP 1

Credenza Hutch

Credenza

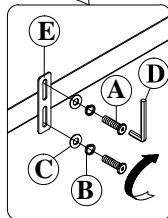
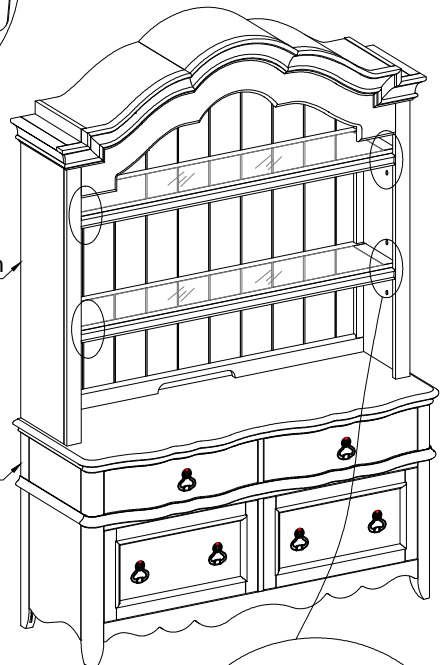

STEP 2

