

Assembly Instructions

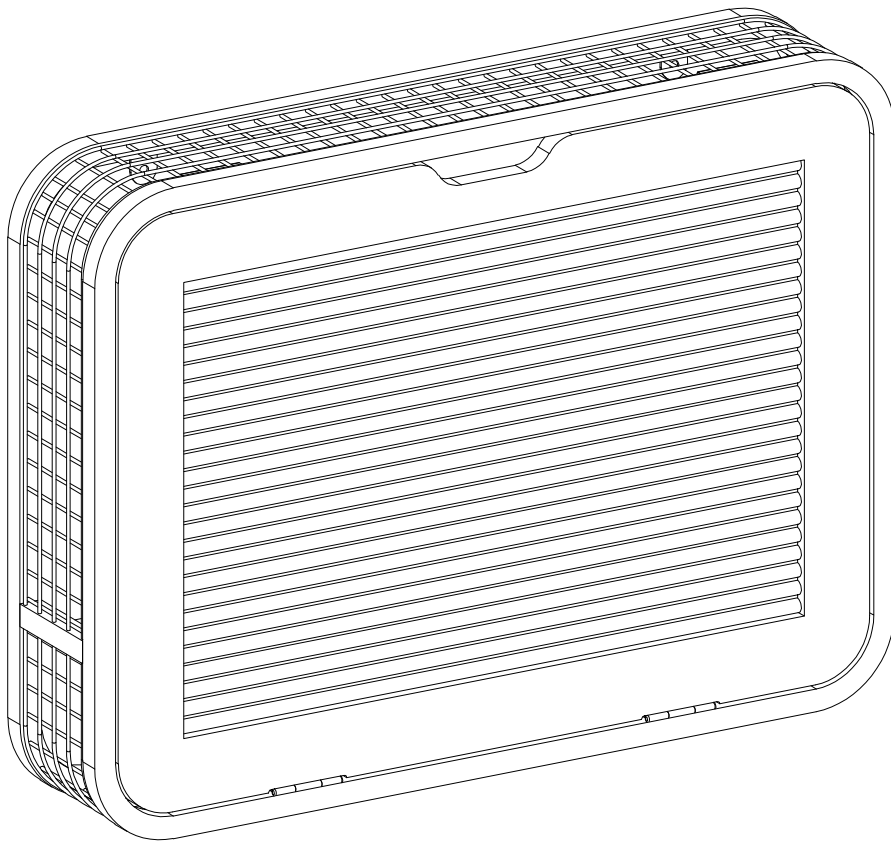

General Assembly Guidelines

- I. Ensure that all parts and hardware are available before beginning assembly.
- II. Follow each step carefully to ensure the proper assembly of this product.
- III. Two people are recommended for ease in the assembly of this product.
- IV. The three main types of hardware used to assemble this product are: wood dowels, screws and bolts.
- V. The provided glue is to secure wood dowels in place. When first inserting dowels, locate the appropriate hole for the dowel, place a small amount of glue in the hole and insert the dowel. Wipe away excess glue immediately.

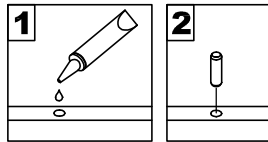

In future assembly steps when dowels are necessary to attach assembly parts together, place a small amount of glue on the end of the dowel before attaching parts together. Wipe away excess glue immediately.

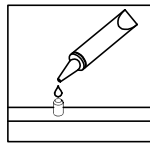

- VI. A Phillips head screwdriver is required for the assembly of this product .

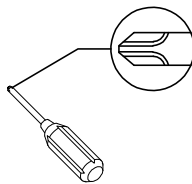

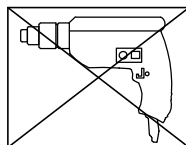

- VII. Power tools should not be used to assemble this product.

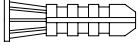
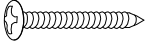

- VIII. Drill may be needed for securing product to wall.

Hardware List

A			Anchor	4 pcs
B		Ø4x50mm	Screw	4 pcs
C			Flat washer	4 pcs

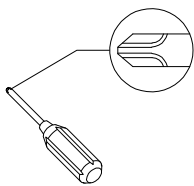

Philips head screwdriver required for assembly
(not included)

*The hardware quantities listed above are required for proper assembly.
Some extra hardware may also have been included.*

Step 1

WARNING

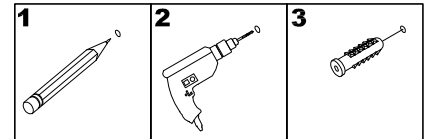

Serious or fatal injuries can occur from furniture tipping over. To prevent the furniture from tipping over we recommend that it is permanently fixed to the wall. Wall anchor and hardware are included with this product. Please make sure hardware is suitable for your walls before installing, as different wall materials may require different types of anchors.

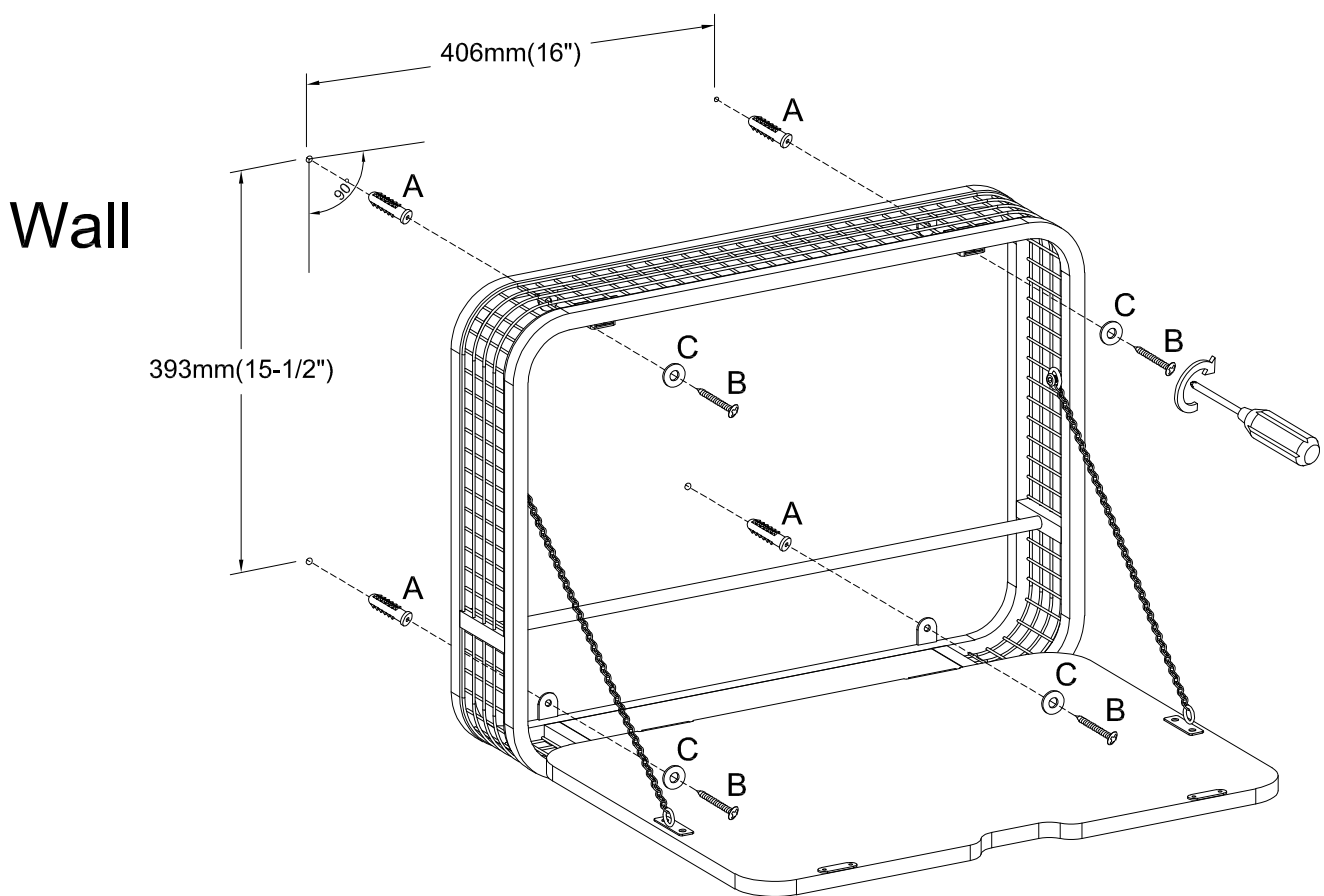

Using screw (B) attach Flat washer (C) to unit into Anchor (A) to wall with Philips head screwdriver as per diagram.

Step 2

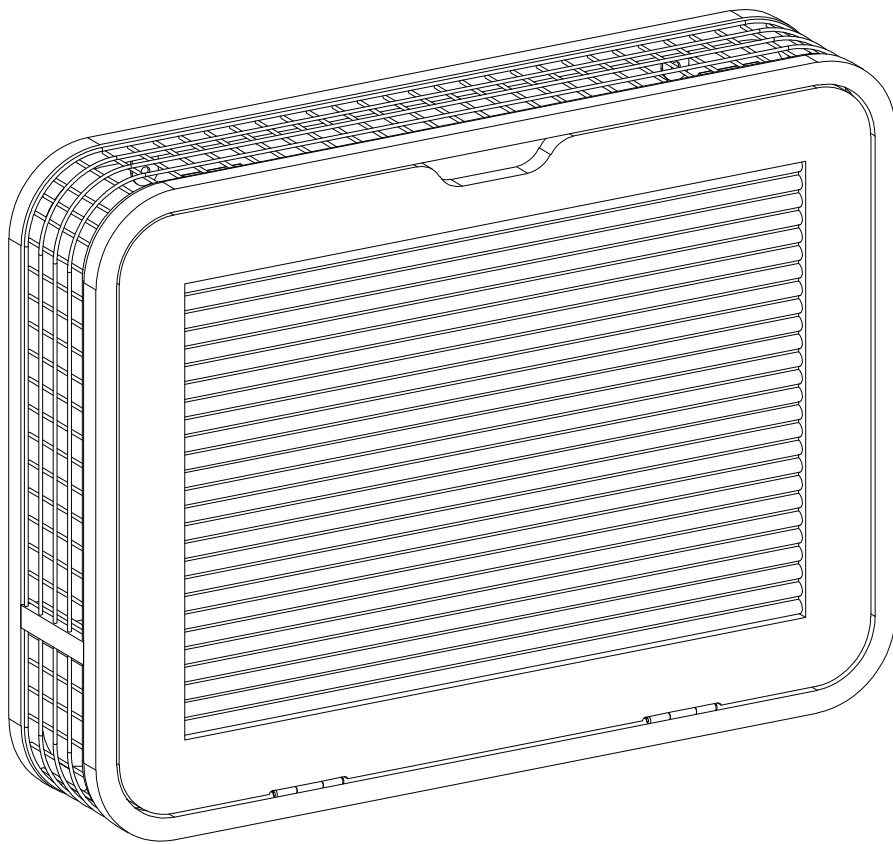

Final Assembly