

Assembly Instructions

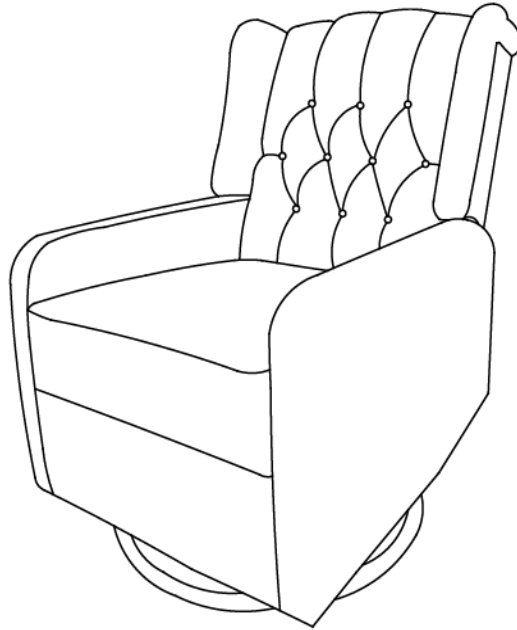

Caution: You must read this before you proceed

Recliner



Parts List





Label	Picture	Description	QTY
A	A line drawing of the chair backrest, showing the tufted diamond pattern and the top edge of the chair's frame.	Chair Backrest	1
B	A line drawing of the chair base with the footrest extended. It shows the swivel base and the curved lines of the chair's frame.	Chair Base with Footrest	1

C		Right Wing	1
D		Left Wing	1

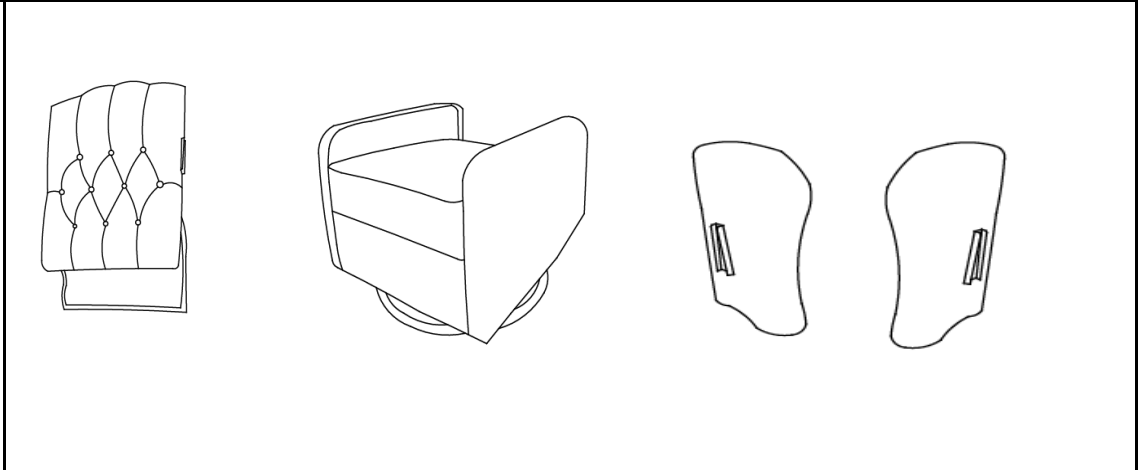
Assembly Preparation

Before Beginning Assembly:



- 
• Read instructions, cover to cover-
- 
• Have 2 adults on hand for assembly-
- 
• Do not assemble on flooring or carpet-
- 
• Assemble on a clean non-marring surface (packing foam)-
- 
• Save all packaging until finished-

Assembly Steps

Overview

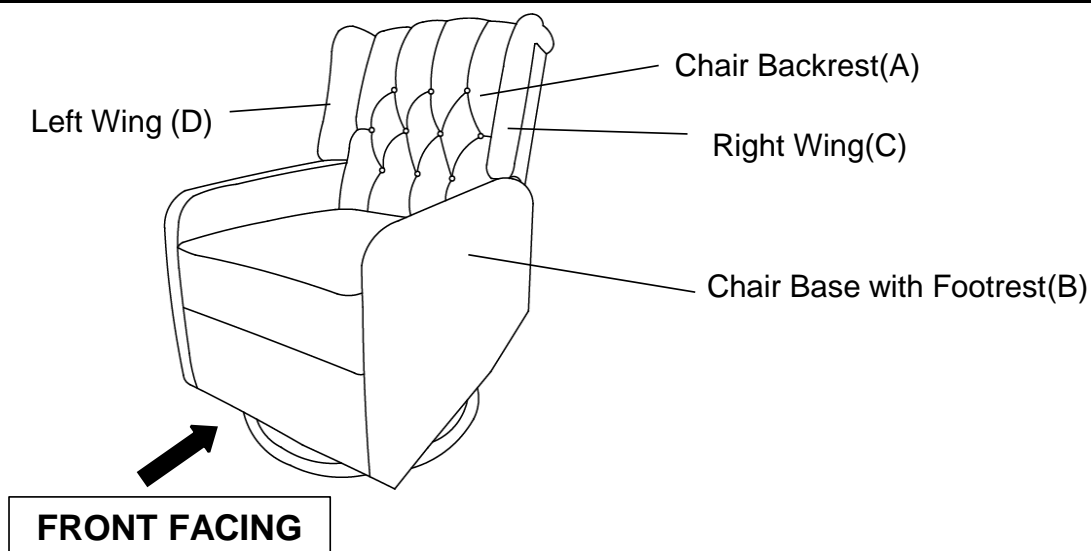

This Recliner has multiple parts and may require up to 30 minutes to assemble. To give you an overview of the Reclining Chair parts, the above picture is to help you put the various parts into perspective. Please read through the instructions below to familiarise yourself with the parts and steps before assembly.

Step 1

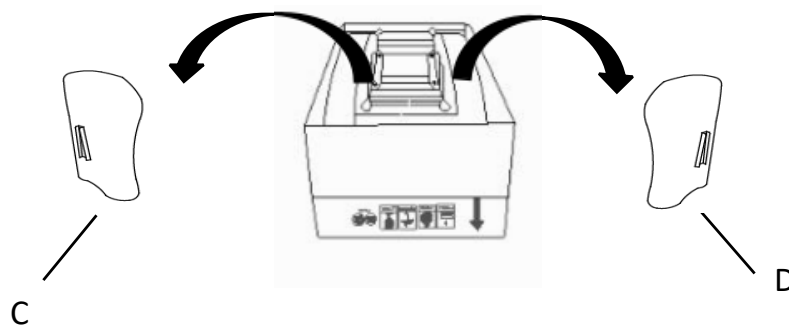

Take out the two non-woven bags inside from the bottom of the Chair Base with Footrest(B). Then take out the Left Wing(D) and Right Wing(C) from non-woven bags.

Step 2

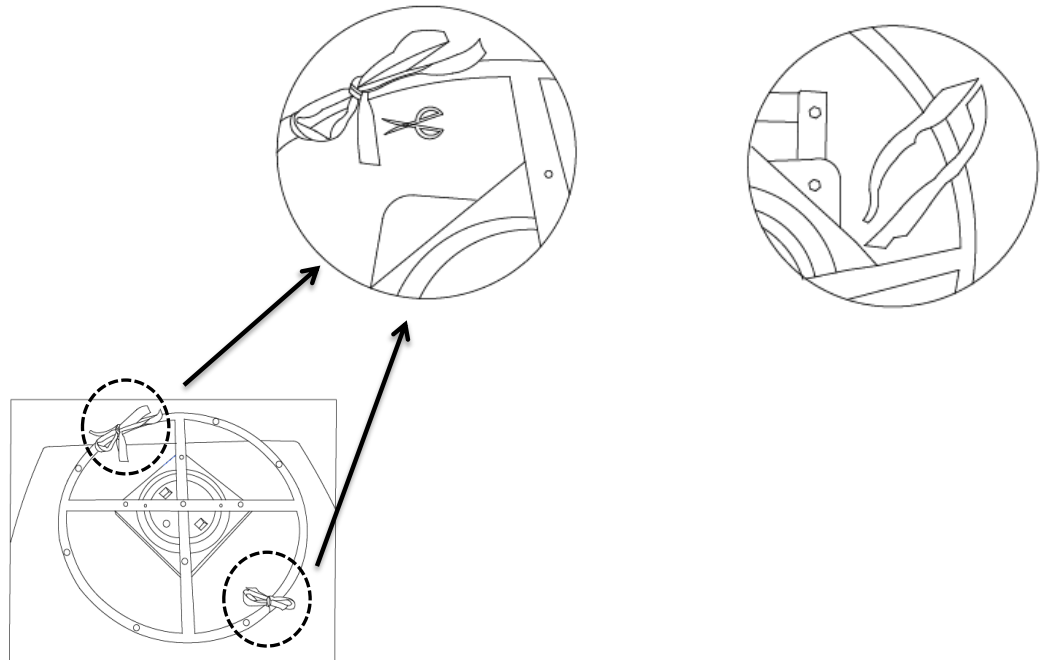

Before using the product, please untie the cloth rope under the mechanism for fixing shaking and swiveling. Please pay attention to safety when operating.

Step 3

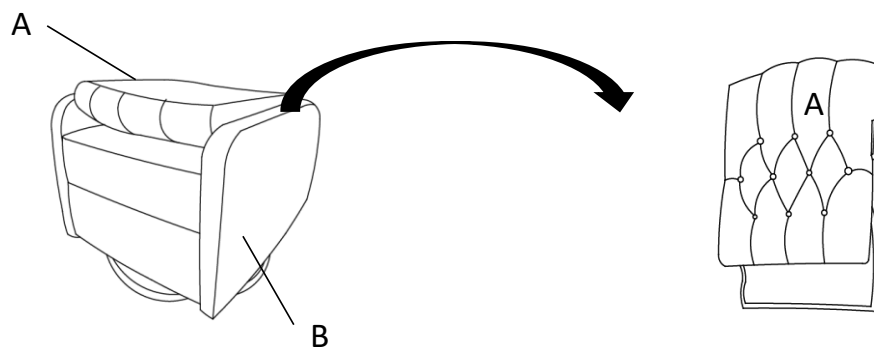

Take out the Chair Backrest(A) from the Chair Base with Footrest(B).

Step 4

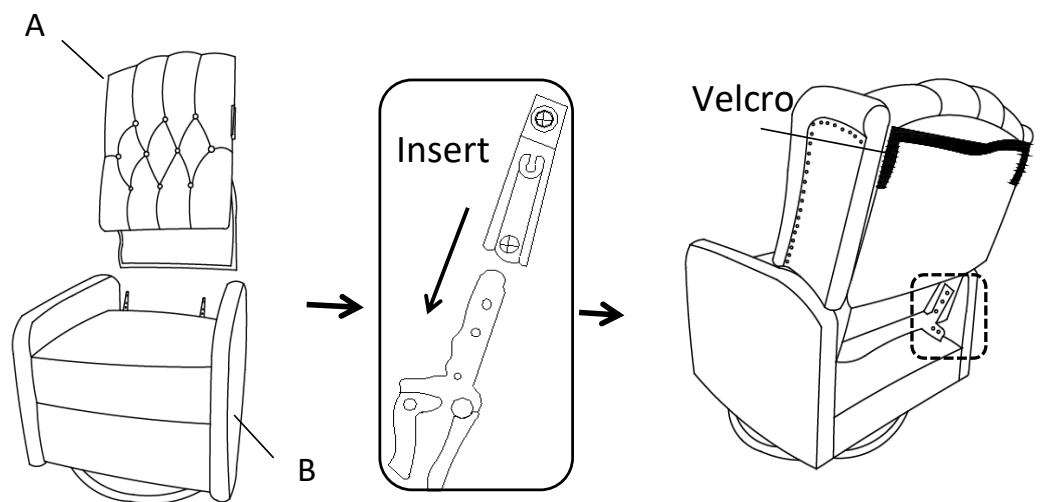

With assistance from your adult partner, hold up the Chair Backrest(A) while standing behind the Chair Base with Footrest(B).
 Insert the small metal arms on the sides of the Chair Backrest(A) into the prefabricated slide lock gadget on the Chair Base with Footrest(B) as shown above.
 Firmly but gently, push the Chair Backrest(A) downwards until the Chair Backrest(A) is fully slotted and locked into position.

Step 5

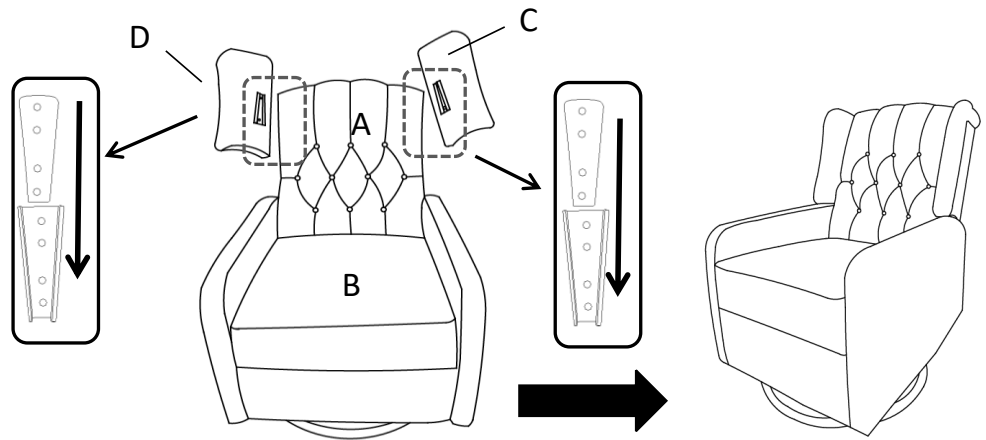

Align the mounting brackets of the Right Wing(C) with those on the Right side of Chair Backrest(A).
 Then slide Right Wing(C) downward by hand to make sure it locks into the position as shown in the picture.
 Repeat the same process to attach the Left Wing(D) into the left side of Chair Backrest(A).

Step 6

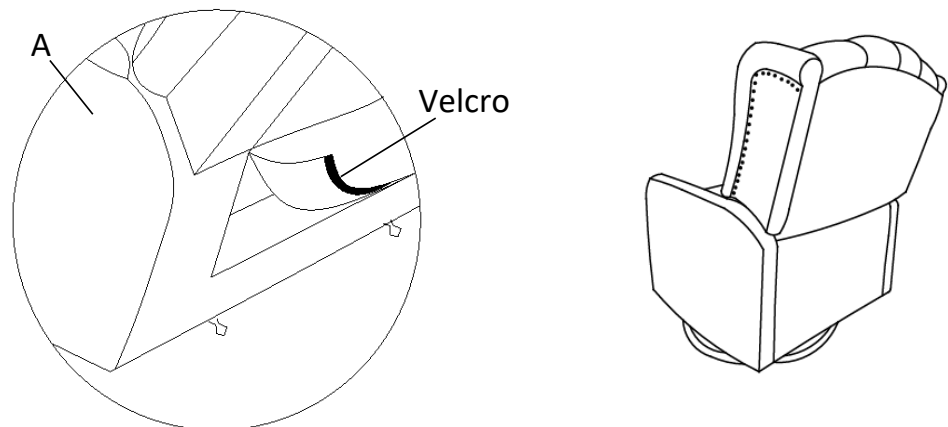

Smooth down the fabric flap on the Chair Backrest(A).
 Run your hands down both sides of the flap, from top to bottom, allowing the velcro tape to adhere to the flap under the seat of the Chair.

Step 8

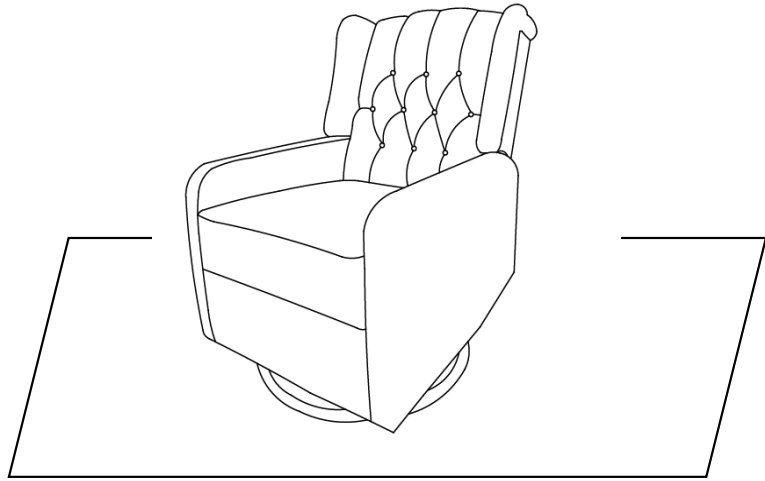

Make sure all parts are connected and securely locked into position.
Your Recliner is ready for use.
This Recliner can only be used on a flat, level surface.

Step 9

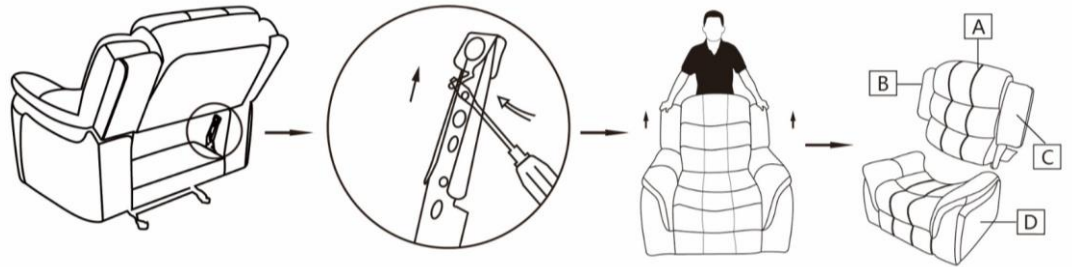

To Disassemble Recliner:

Open the flap on the Chair Backrest(A), use a screwdriver (Don't use your fingers) pressing outward on the metal ear on the preattached Metal Bracket on one side of the Chair Base(B).
With assistance of your adult partner to keep the Chair Base(B) in place, pull the Backrest(A) upward at the same time, repeat the same step for another side.
Then the Chair Backrest(A) can be taken out.

Warning



Correct Way to Use



Incorrect Way to Use



Incorrect Way to Use

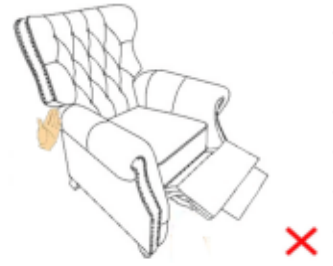

Incorrect Way to Use

Do not allow children to play on the chair.
Always leave the chair in an upright and closed position after use!
Keep hands and feet clear of the footrest mechanism and ANY gaps.
Only the occupant should operate the chair.

User Instructions

Recliner

Please read the Instruction Manual below carefully before use.

This is a Recliner. At anytime in a reclined seat position or in the upright position. You may enjoy the rocking motion by using your body weight in a back-front rocking motion, and also the swivel motion.

Supervise children, when in use of this Recliner.

To get into the Recline position:

Sit into the seat.
Open the trigger on the outside of the right armrest.
Use your body weight and push backwards into the seat into a fully reclined position.







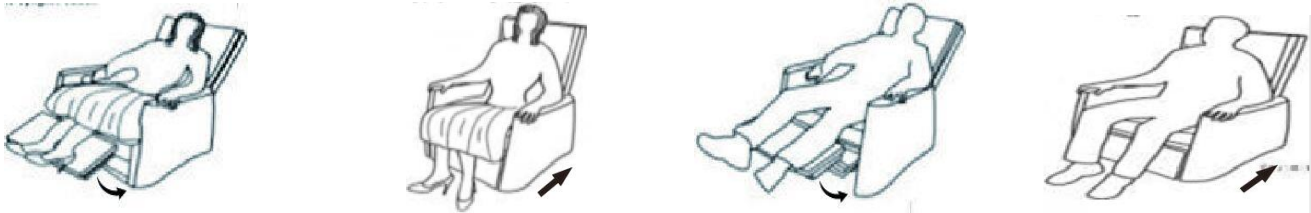





To move the Chair back into the Upright Position:

Tilt your body weight slightly forward and upwards.
The seat back will come up to an upright position.
Use your feet to push the Footrest down.
The Chair will automatically lock when it is in the fully upright position.
Where necessary, use your arms help lift/push yourself out of the seat

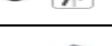

Care & Maintenance

	<ul style="list-style-type: none">• Furniture may scratch floors. We recommend using furniture pads to protect your floors.
	<ul style="list-style-type: none">• Do not put hot items directly on furniture surface.
	<ul style="list-style-type: none">• Do not clean furniture with harsh cleansers or polish.
	<ul style="list-style-type: none">• Do not place furniture under direct sunlight.
	<ul style="list-style-type: none">• Do not place furniture near heating or cooling vents.
	<ul style="list-style-type: none">• Do not write on furniture without a padded barrier to protect the surface.
	<ul style="list-style-type: none">• Do not place furniture outside . For indoor use only.
	<ul style="list-style-type: none">• Not for commercial use. For residential use only.
	<ul style="list-style-type: none">• Stains may be removed with mild soap solution and damp cloth.
	<ul style="list-style-type: none">• Children should not climb or jump on the furniture.
	<ul style="list-style-type: none">• Dust and pick-up spills using a clean, non-colored, lint-free cloth.