



ASSEMBLY INSTRUCTION

MODEL NO:
DRESSER & MIRROR

(BOX 1)
BOX OF DRESSER

ITEM	DRAWING	DESCRIPTION	Qty
A		Dresser	1

(BOX 2)
BOX OF MIRROR

ITEM	DRAWING	DESCRIPTION	Qty
A		Mirror	1
B		Mirror support	2

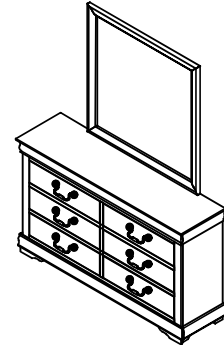

**COMPLETED
DRESSER & MIRROR
ASSEMBLY**

(BOX 2)
HARDWARELIST

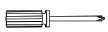
ITEM	DRAWING	DESCRIPTION	Qty
1		CB Screw (M4*35mm)	2pcs
2		SCREW DRIVER (*)	1pcs

The manufacturer does not provide item 2.

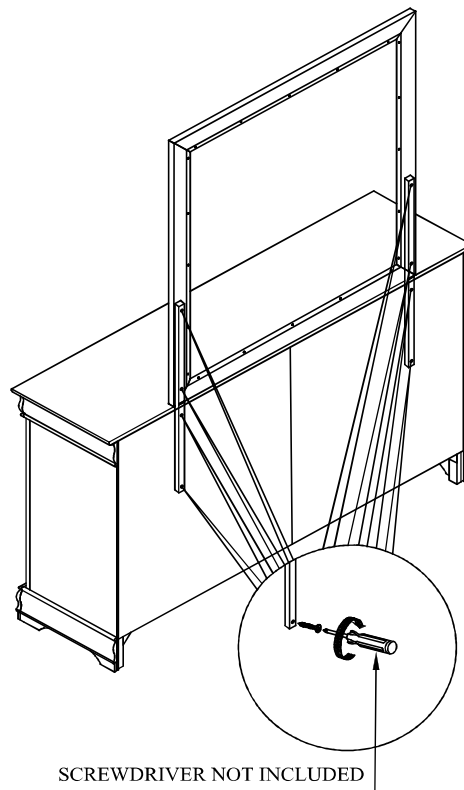

THE ANTI TIPPING HARDWARE IS LOCATED IN THE RIGHT SIDE FRONT DRAWER OF DRESSER.

NOTE: MUST TIGHTEN SCREWS PERIODICALLY WITH USE SCREWS MAY BECOME LOOSE.

CHECK TIGHTNESS OF ALL SCREWS EVERY 6-8 WEEKS.

CLEANING INSTRUCTION

After assembled, clean & polish the completed parts if necessary with soft cloth and industrial recognized furniture polish.

MADE IN VIETNAM