

CARE AND MAINTENANCE



















Unplug lamps before using any cleaning solutions. Dust shades with a feather duster or with an appropriate vacuum-brush attachment. Wipe with a soft, dry cloth and clean lamp bases with the methods appropriate to the material. Avoid the use of chemicals and household cleaners as they may damage the finish.

NOTICE & IMPORTANT SAFETY INSTRUCTIONS

- * Please make sure that you have all parts indicated before you begin assembly of this item
- * This item should be assembled on a soft surface to prevent scratching the finish during assembly
- * To reduce the risk of fire, electrical shock or injury to persons or property, please follow the guideline below for safe use and installation
- *The external flexible cable or cord of this luminaire cannot be replaced;
If the cord is damaged, the luminaire shall be destroyed

**This portable lamp has a polarized plug (one blade is wider than the other) as a safety feature to reduce the risk of electric shock. this plug will fit in a polarized outlet only one way. if the plug does not fit fully in the outlet, reverse the plug, if it still does not fit, contact a qualified electrician. never use with an extension cord unless the plug can be fully inserted. do not attempt to defeat this safety feature.

Part List and Hardware List

PIECE	DESCRIPTION	PICTURE	QUANTITY	PIECE	DESCRIPTION	PICTURE	QUANTITY
A	Metal frame		1X	J	Tube		1X
B	Tube foot		1X	K	Tube		1X
C	Wood frame		1X	L	Rotary connector		1X
D	Tube		1X	N	Socket		1X
E	Fixed frame		1X	O	Shade		1X
F	Tube		1X	P	Out ring		1X
G	Screw		6X	Q	Bulb		1X
H	Big Spanner		1X	R	Screw		3X
I	Tube		1X	S	Small spannel		1X

Product Dimensions: 15" X15"X 63"H

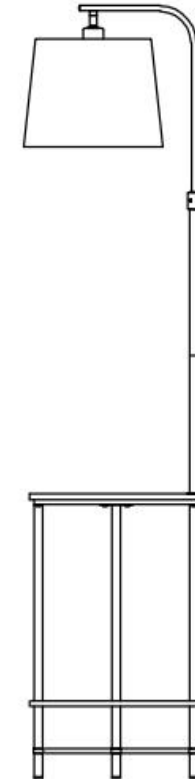

PREPARATION

Before beginning assembly of product, make sure all parts are present. Compare parts with package contents list and hardware contents list. If any part is missing or damaged, do not attempt to assemble the product.

Estimated Assembly Time: 15 minutes.

PLEASE USE ON/OFF TYPE "A" BULB MAX 100-WATT OR CFL BULB MAX 23-WATT OR LED BULB MAX 12-WATT

THERE IS LED 9-WATT BULB IN THE BOX

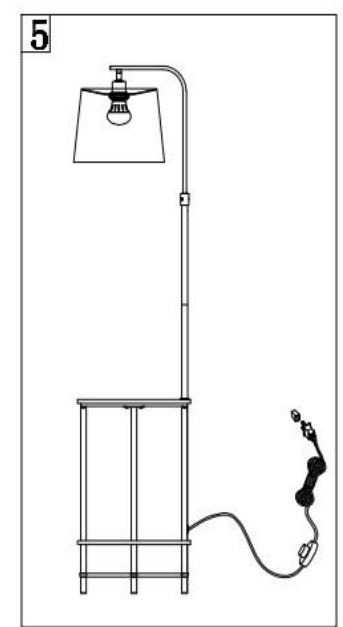
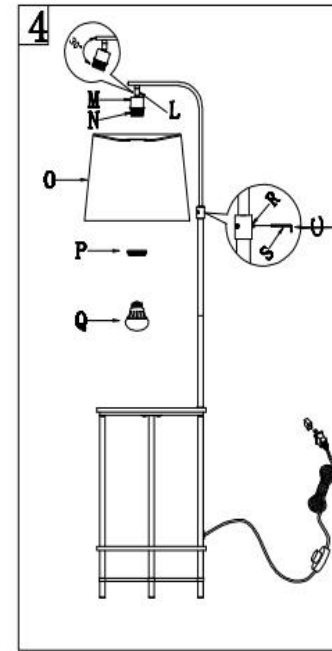
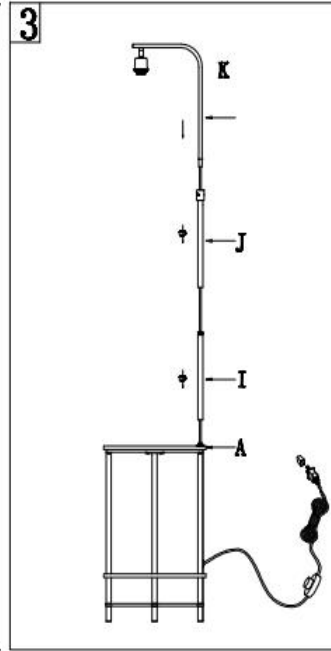
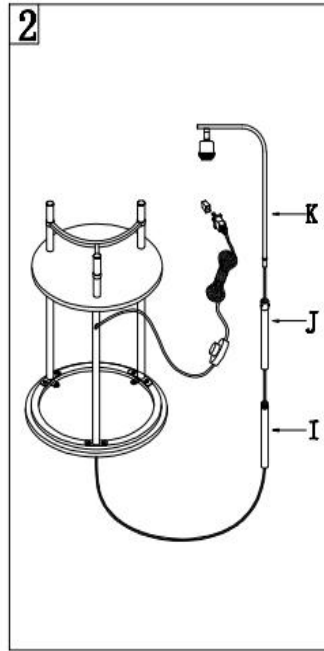
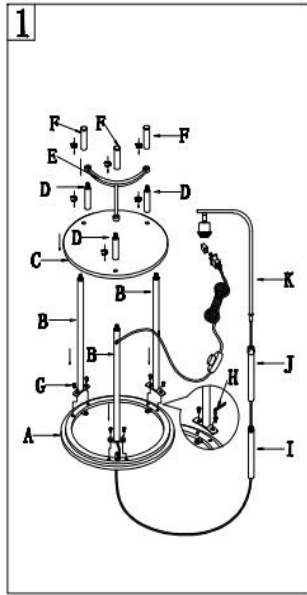

Step 1

Make sure all parts could be aligned before assemble

Unpack all parts from cartons carefully.

Put the top metal frame reversely.

Fix the Metal foot(B)on to the Metal frame(A)with screws(G) by using Big Spanner(H)

Put the Wood frame(C)on the Metal foot(B),Then Screw the Metal foot(B)to the tube(D) through wood frame(C).

Screw the tube(D)to the tube(F) through fixed frame(E)

Step 2, 3.

Insert the tube(J) into the tube(I).

and Insert the tube(K) into the tube(J).

Then put the lamp body straight,

Insert the tube(I) into the metal frame(A)

Step4

After adjusting the positive direc

Fix the Tube(K) on to the Tube(

with screws(R) by using small

spanner(S). Put the shade(O)

on the Socket(N), then fix the shade by out ring(P).

Insert the bulb(Q) into the socket(N).

Step5

Put the light on a level

surface to check

if everything is stable.

ENJOY YOUR LAMP