

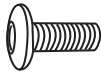



# ASSEMBLY INSTRUCTION

HEFTBSWF-01JYF3  
HEFTBSWF-01C2WA  
HEFTBSWF-01C98K

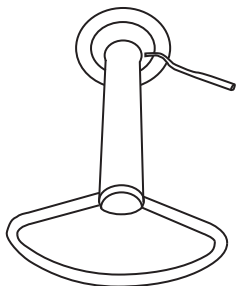
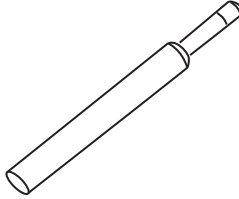

1. Please unbox the item from the side with an open-label and put a carpet on the floor to avoid scratching it.
2. Follow the installation instructions. Please confirm all accessories are preset before installation.
3. Do not fully tighten the screws during initial assembly. Fully tighten screws only once all pieces which are correctly assembled.
4. If you encounter any problems during installation, please contact our customer service.

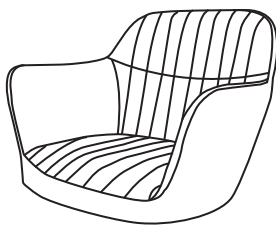
Item no.	Reference Image	Qty.	Item no.	Reference Image	Qty.
A	 M6X16mm	x4	B		x1
C		x1	D		x1
E		x1	F		x1

  
**WARNING!**  
The black cap on  
the top of gas lift  
must be removed  
before assembly

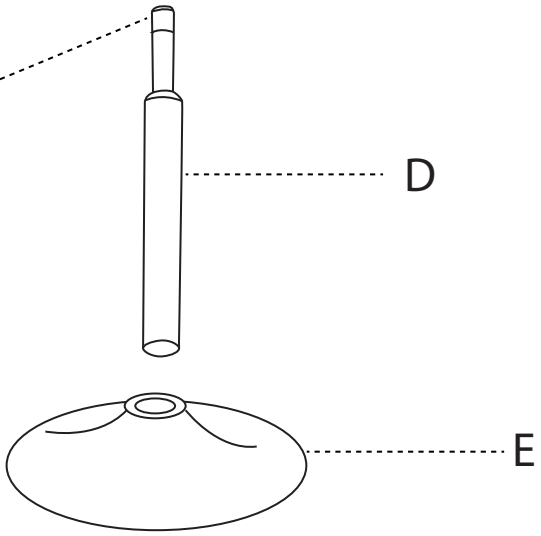

①

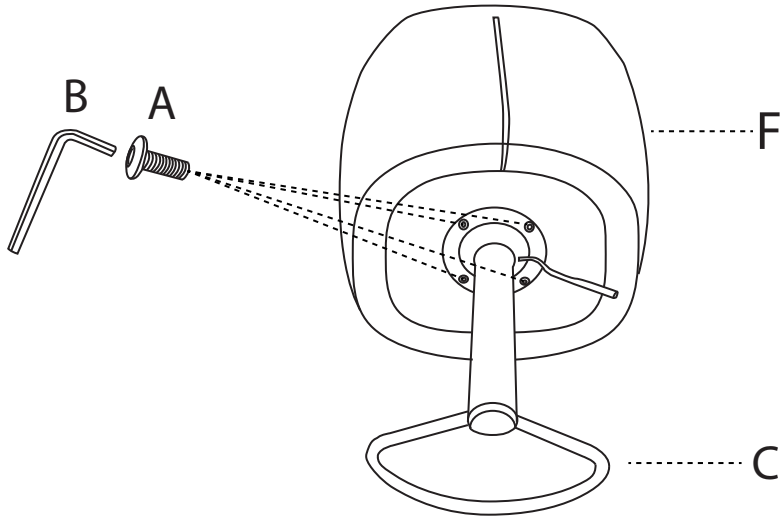

②

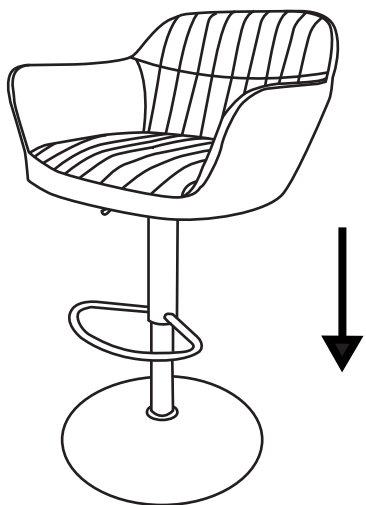

③