

CRYSTAL LED FLUSH MOUNT LIGHT

SAFETY PRECAUTIONS

- Do not use the device if the power cord or other parts are damaged.
- The damaged power cord can only be repaired by product technical service personnel or qualified personnel, do not try to repair the lamp yourself.
- Do not expose the product to extreme temperatures, high humidity or strong mechanical force.
- Keep lamps away from heat sources.
- Wipe the lamp only with a soft dry cloth, do not use solvent-based or detergents otherwise the product may be damaged.
- Do not immerse the lamp in water, and do not expose the product to moisture or rain.
- **Warning:** Follow the instruction to install and use to prevent personal safety accidents, such as lamp damage, falling down, electric shock, fire, etc. Do not dismantle the lamp or replace any parts.

FEATURE TIPS

- The lamps are made of mirror stainless steel, which will not rust or corrode, and will last for a long time.
- The crystal adopts the first-class K9 crystal in the market, the light refraction is dazzling, the brightness is high, and the light is soft and not dazzling.
- Led light source has the advantages of long life, small size, low power consumption, multi-transformation, healthy use, high luminous efficiency, no noise, and stable performance.

SPECIFICATIONS

Product Name: Ceiling Lamp

Model: LG0964

Power Supply: 165-265V 50/60HZ

Light Source: LED

Size of the Light: 60x60x20cm

ENVIRONMENTAL PRECAUTIONS

- Used products and batteries must not be mixed with household waste, for proper disposal and recycling of waste electrical and electronic equipment and used batteries, please store them in the collection points provided for this purpose in accordance with national regulations.
- By properly disposing of discarded equipment and used batteries, you will help preserve a valuable resource and prevent the negative impact that waste can have on human health if not properly disposed of.
- For more information on collecting and recycling waste electrical and electronic equipment, please contact your municipality, your waste disposal department.



COMPONENTS

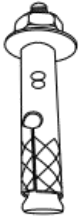

Expansion Screw
(x4)

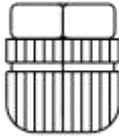

Nut (x4)



Bracket (x1)

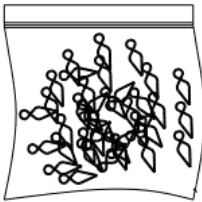

(x40)



Octagonal Bead +Crystal Ball (x36)

INSTALLATION

- Suggest to ask professional electrician to install.
- Please tear the protective film before installing the lamp.
- After removing the mounting bracket of the luminaire, position the hole and tighten the nut on the bracket (this is very important).
- After turning on the light, do not touch the light source to avoid injury. Do not use this luminaire in the bathroom or in a humid environment.

Step 1

Mark with a pen.

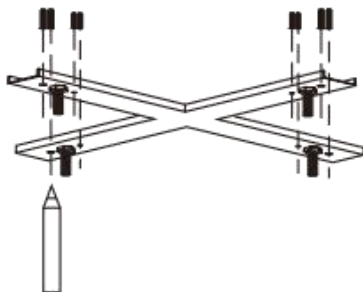

Step 2

Drill.



Step 3

Blast bolts (or expansion glue into the ceiling).

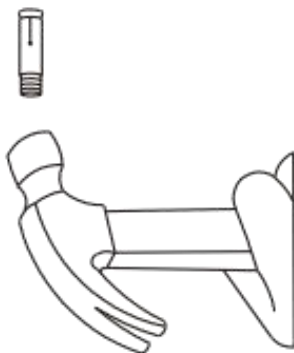

Step 4

Mount bracket for fixing lamp.

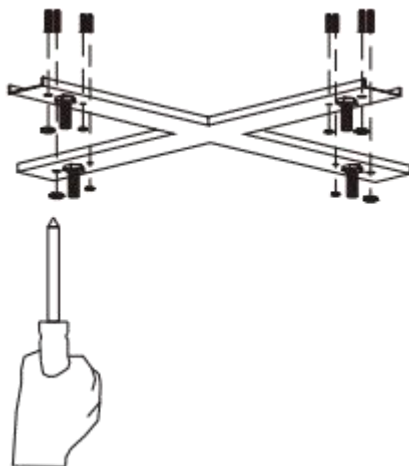

Step 5

Wear gloves (to keep the lamps clean and prevent injuries).



Step 6

Connect the zero wire and the fire wire, test the electricity, make sure the lamp works normally (don't need to distinguish the zero wire and the fire wire, the middle ground wire).

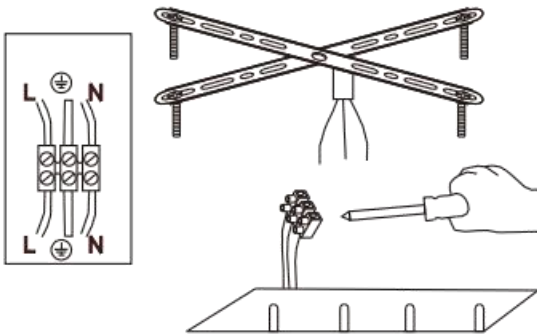

Step 7

Fix the hole of the lamp and screw on the nut, the lamp is installed.

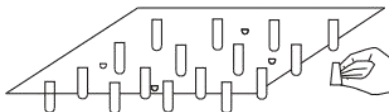
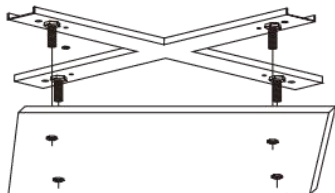

Step 8

Hang the crystal ball fitting.

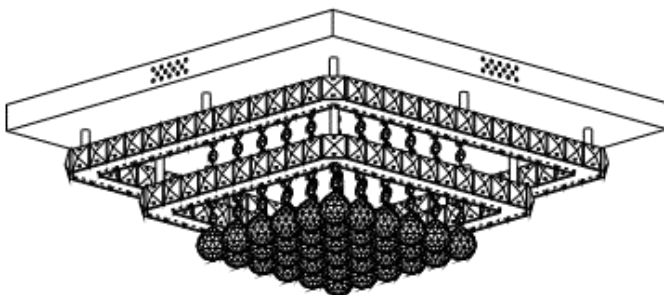

ACCESSORIES

Step 1

Remove the accessories.

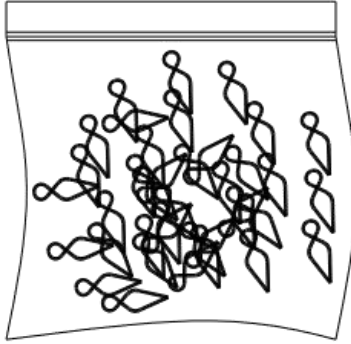

Step 2

Hold it with tongs.

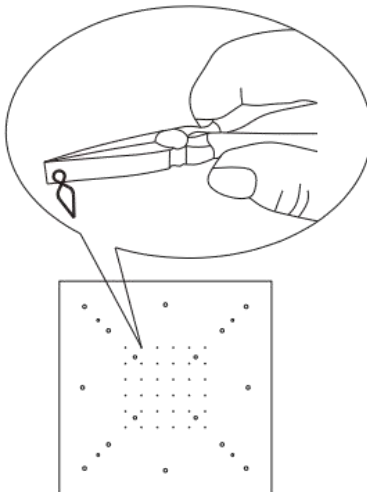

Step 3

Force it into the hole.

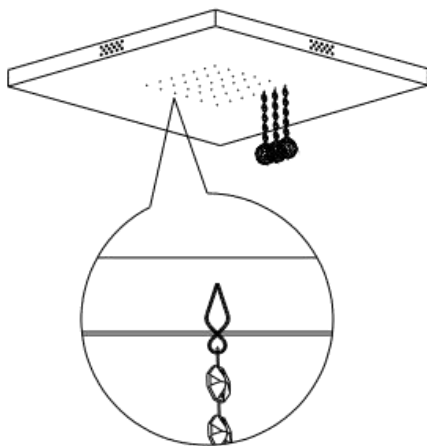

Step 4

Hang crystal decorative balls.

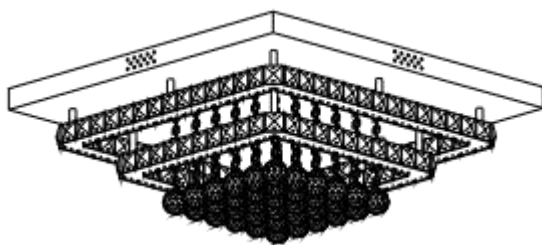

CLEANING & CARE

- The power supply must be cut off before cleaning the lamps and maintenance, and the structure of the lamps and the parts of the lamps cannot be changed.
- Try not to switch frequently when using lamps, so that the instantaneous current of the lamp bead is greater than the current during normal operation, which greatly reduces its service life.
- Wear gloves and wipe with a dry cloth feather duster and pay attention to prevent moisture intrusion, so as to avoid long-term corrosion damage or leakage and short circuit.
- Special reminder that moisture can easily cause the lamps to rust and paint and shorten the service life of the lamps. Therefore, moisture-proof is the key to the maintenance of lamps. The lamps work normally for 2-3 hours a day, which can dehumidify the lamps and increase the indoor temperature, dehumidification.
- **Warning:** Cut off the power and wait until it's fully cool down before cleaning and other operation.