

**A** • Unscrew the cover holding screws, remove housing cover from the fan switch housing

**B** • Unscrew center-stud.

These procedures are apply to all the light kit

**NOTE :** IF YOU ARE INSTALLING THE CEILING FAN LIGHT FIXTURE CONTINUE WITH Figure 16.

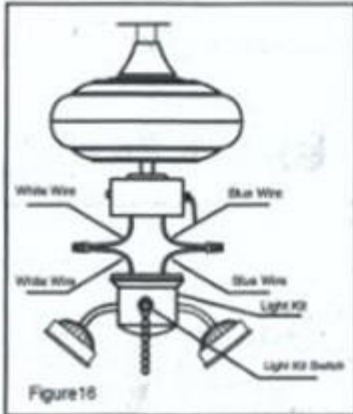

Connect the Blue-wire from the switch housing to the Blue-wire from the motor ,Connect the White-wire from the switch housing to the White-wire from the motor .

**C** • Attach the switch cover to the switch housing by connecting the wire (black and white) through the hole of the cover and screw it onto the housing.

**D** • Put the two single wires in switch housing, one is white(or gray) and the other is the blue(or orange)

**E** • Connect them to the light kit wires with wire connectors.

- White(gray) to white
- Blue(orange) to balck

These procedures are apply to all the light kit

• Carefully push all wires back into switch housing of fan.Then tighten the switch cover by the original screws.



**Remark :** These process are fit for installing the light kit with four, five or six lamp-socket ,and using E27 lamp .

Here are some suggestions to help you maintain your fan

1. Because of the fan's natural movement, some connections may become loose. Check the support connections, brackets, and blade attachments twice a year. Make sure they are secure. (It is not necessary to remove fan from ceiling)
2. Clean your fan periodically to help maintain its new appearance over the years. Do not use water when cleaning. Use only a soft brush or lint-free cloth to avoid scratching the finish. The plating is sealed with a lacquer to minimize discoloration, or tarnishing. This could damage the motor, or the wood, or possibly cause an electrical shock.
3. You can apply a light coat of furniture polish to the wood for additional protection and enhanced beauty. Cover small scratches with a light application of shoe polish.
4. There is no need to oil your fan. The motor has permanently lubricated sealed ball bearings.

### **WARNING**

**MAKE SURE THE POWER IS OFF AT THE ELECTRICAL PANEL BOX BEFORE YOU ATTEMPT ANY REPAIRS. REFER TO THE SECTION, (MAKING ELECTRICAL CONNECTIONS).**

### **TROUBLESHOOTING**

Check on the following before lodging a service report

<b>Problem</b>	<b>Problem</b>	<b>Problem</b>
Fan not moving	1. Main cables not connected 2. Wire connection loose	1. Check mains and branch circuit breakers or fuse 2. Check the line wires connections to the fan and switch housing
Fan noisy	1. Housing screws are loose 2. Wire nut connections rattles against each other 3. Canopy touches the ceiling	1. Tighten all screws 2. Separate and store neatly the wire nut connections 3. Check that the canopy is not touching or too close to the ceiling
Remote control Not working	1. Remote and receiver code different 2. Battery not installed 3. Weak battery	1. Check that the codes are exactly the same 2. Install the remote control battery 3. Change a new battery

**NOTICE: PLEASE FOLLOW EVERY INSTALLATION  
PROCEDURE STATED BELOW TO OBTAIN  
OPTIMUM SAFETY**

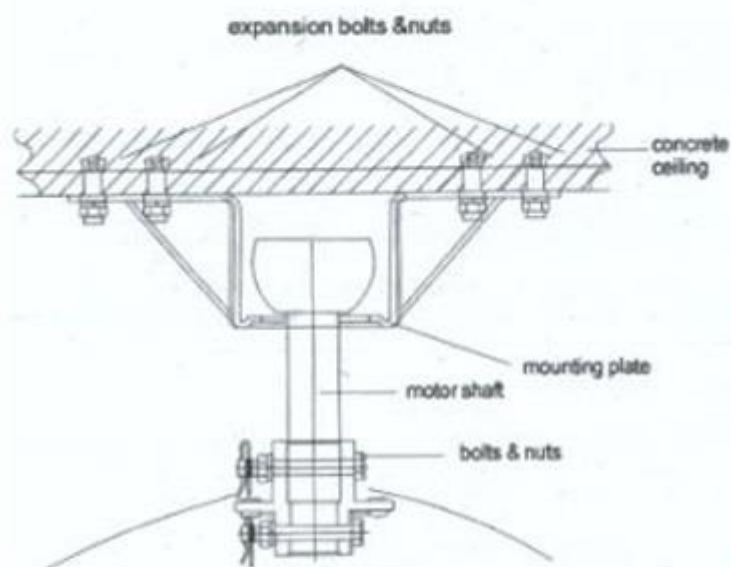

## Finishing the Fan Installation

1. Align the your screw holes in the canopy with the four screw holes in the mounting plate.
2. Secure the canopy in place by using the four mounting screws that were removed in step 2. Described in page 5.
3. You may now proceed to install the decorative support rods.

## Finishing the Fan Installation

**Speed** settings for warm or cool weather depend on factors, such as the room size, ceiling height, number of fans, and so on.

The fan shipped from the factory with the reversing switch position to circulate air downward. If airflow is desired in opposite direction, turn your fan off and wait for the blades to stop turning then slide the reversing switch to opposite position, and turn fan off again. The fan blades will turn to the opposite direction and reverse the airflow.

1. **Speed switch**- the speed switch features a low, Med, Hi and Off buttons to select the desired speed of operation and turn the fan ON or OFF.
2. **Lights switch**- to control the light kit.

**Warm weather**- (Forward) A downward air flow creates a cooling effect as shown in figure 14. This allows you to set your air conditioner on a higher setting without affecting your comfort.

**Cool weather**- (Reverse) An upward airflow moves warm air off the ceiling area as shown in Figure 15. This allows you to set your heating unit on a lower setting without affecting your comfort.

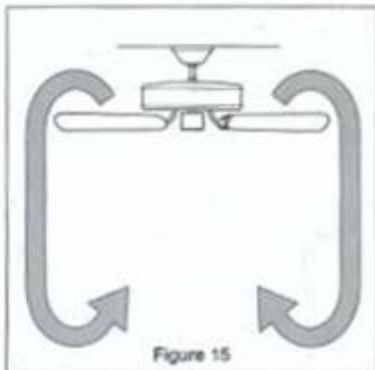
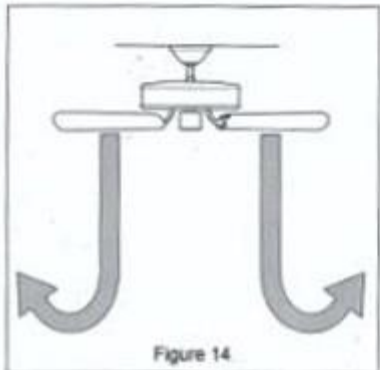

## Marking the Electrical Connections

**REMEMBER** to disconnect the power, if you feel that you do not have enough electrical wiring knowledge or experience, have your fan installed by a licensed electrician.

Follow the steps below to connect the fan to your household wiring use the wire connection units supplied with your fan. Secure the wire connection units with electrical tape. Make sure there are no loose strands or connections.

1. Connect the ground conductor of the 220-240V supply (this may be a bare wire or a wire with green colored insulation) to the green ground leads (s) the fan (Figure 12).
2. There are four color wires coming from the top of the motor:  
WHITE-Live wire for fan  
BLUE-Light Kit wire  
GREEN-Ground wire  
BLACK-Neutral wire
3. Connect fan wires to ceiling wires:  
White to white, black to black, green to Green. If you will be using a Light Kit, Then connect the blue to blue wire. If not, Cap the blue wire off with a connector
4. After connecting the wires, spread them apart so that the green and white wires are on one side and the black is on the other side
5. Turn the wire connecting nuts upward and Push the wires into the outlet box.

### WARNING

EACH WIRE NUT (WIRE CONNECTOR) SUPPLIED WITH THIS FAN IS DESIGNED TO ACCEPT UP TO ONE 12 GAUGE HOUSE WIRE AND TWO WIRES FROM THE FAN. IF YOU WIRING OR MORE THAN ONE HOUSE TO CONNECT TO THE FAN WIRING CONSULT AN ELECTRICIAN FOR THE PROPER SIZE WIRE NUTS USE.

### WARNING

ELECTRICAL DIAGRAMS ARE FOR REFERENCE ONLY. OPTIONAL USE OF ANY LIGHT KIT SHALL BE FULLY LISTED AND MARKED SUITABLE FOR USE WITH THIS FAN.

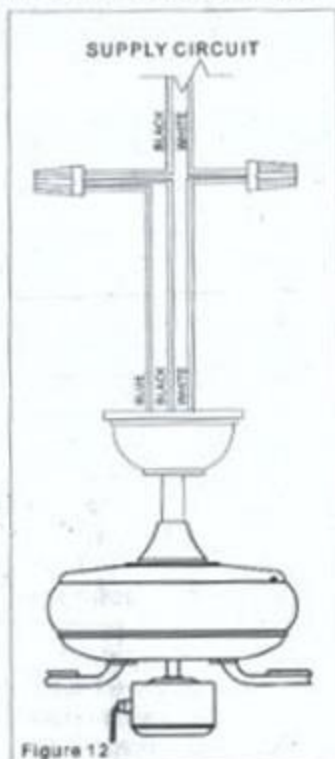

Figure 12

### warning

ANY WIRES INSIDE ARE NOT ALLOWED TO REPLACE OR CHANGE IF IT IS DAMAGED

## HANGING THE FAN

**REMEMBER** to turn off the power. Follow the steps below to hang your fan properly.

**NOTE:** This fan is recommended for the standard ceiling mounting using the downrod installation, the distance from the ceiling to the bottom of the light kit will be approximately 19 inches.

**THE FAN MUST BE MOUNTED WITH A MINIMUM OF 2.3m CLEARANCE FROM THE TRAILING EDGE OF THE BLADES TO THE FLOOR.**

**IF YOU FEEL THAT YOU DO NOT HAVE ENOUGH ELECTRICAL WIRING KNOWLEDGE OR EXPERIENCE, CALL A LICENSED ELECTRICIAN.**

1. Remove the canopy ring from the canopy by turning the ring to the right until it was removed (Figure 8)
2. Remove the mounting plate from the canopy by loosening the four screws on the top of the canopy. Remove two non-slotted screws and loosen the slotted screws. This will enable you to remove the mounting plate (Figure 9)
3. Route the wires exiting the top of the fan motor through the decorative glass housing, route the wires through the canopy and canopy ring then through the downrod/ball assembly (Figure 10).
4. Loose, but do not remove, the set screws on the collar on the top of the motor housing.
5. Align the holes at the bottom of the downrod with holes in the collar on top of the motor housing (Figure 10). Carefully insert the hanger pin through the holes in the collar and downrod. Be careful not to jam the pin against the wiring inside the downrod. Insert the locking pin through the hole near the end of the hanger pin until it snaps into its locked position, as noted in the circle inset of Figure 10.
6. Re-tighten the set screws on the collar the top of the motor housing.

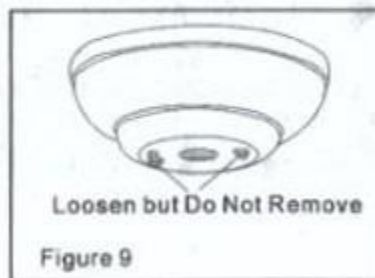
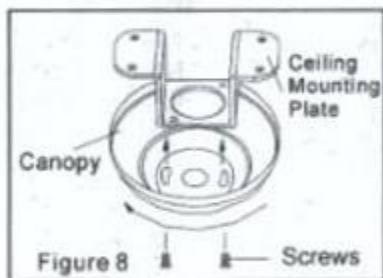

All blades are grouped by weight. Because natural woods vary in density the fan may wobble even though the blades are same weight.

The following procedure should correct most fan wobble. Check after each step.

1. Check all the blades and the blade bracket screws are secured.
2. Most fan wobble problems are caused when blade levels are unequal. Check this level by selecting a point on the ceiling above the tip of one of the blades. Measure from a point on the ceiling. Measure this the distance as shown in Figure 7 Rotate the fan until the next blade is positioned for measurement. Repeat for each blade. Measurements deviation should be within  $1/8"$  .Run the fan for 10 minutes.
3. Use the enclosed blade balancing kit if the blade wobble is still noticeable.

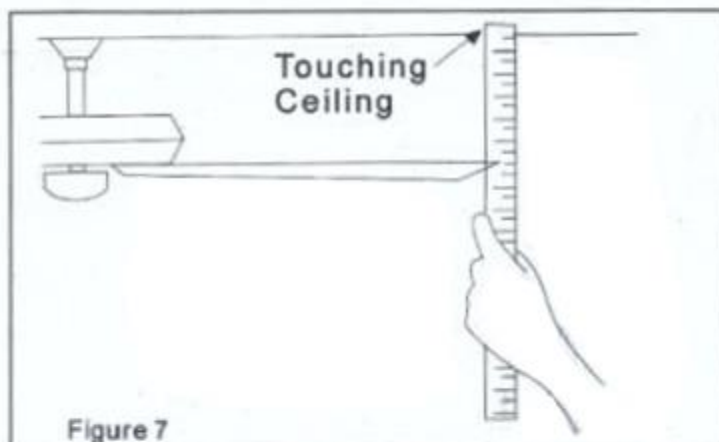

### WARNING

TO REDUCE THE RISK OF PERSONAL INJURY, DO NOT BEND THE BLADE HOLDERS WHILE INSTALLING BALANCING THE BLADES, OR CLEANING THE FAN. DO NOT INSERT FOREIGN OBJECTS BETWEEN ROTATING FAN BLADES.

Note: You may need a longer down-rod to maintain proper blade clearance when installing on a steep, slope ceiling. The maximum angle allowable is 15°. If the decorative touches downrod, remove the decorative canopy bottom cover and turn the canopy 180° before attaching the canopy to the mounting plate.

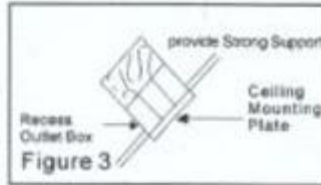

To hang your fan where there is an existing fixture but no ceiling joint you may need an installation hanger bar as shown in Figure 4.

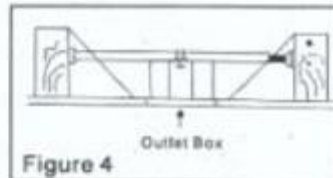

## Attaching the Fan Blades

Note: Your fan blades are reversible. Select the blade side finish which best accentuates your decor.

1. Attach blade to blade bracket using the screws supplied (Figure 5). Start a screw into the bracket. Repeat for the two remaining screws.
2. Tighten each screw securely.
3. Rotate the center flywheel until the blade bracket screw holes in the center flywheel are visible from the cut-out in the top light kit plate (Figure 6).
4. Insert the blade/blade bracket assembly through the hole in side of the center flywheel, align the 2 screws holding blade bracket with the screw hold in the center flywheel and secure with screws supplied (Figure 6).
5. Repeat steps 1, 2, 3 & 4 for the remaining blades.

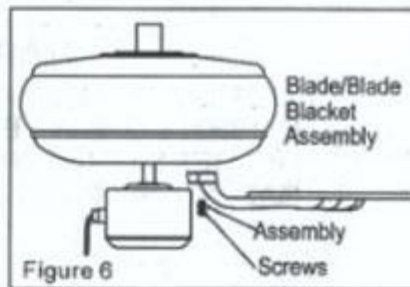
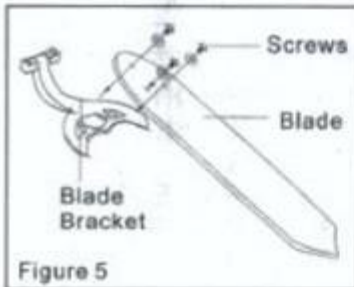

## Tools Required

Phillips screw driver, straight slot screw driver, adjustable wrench, step ladder, and wire cutters.

## Tools Required

If there is no existing mounting box, then read the following instructions. **Disconnect the power by removing the fuses or by turning off the circuit breakers.**

Secure the outlet box directly to the building structure. Use appropriate fasteners and building materials. The outlet box and its support must be able to fully support the moving weight of the fan (at least 35 lbs). **Do not use plastic outlet boxes.**

### WARNING

**TO REDUCE THE RISK OF FIRE, ELECTRIC SHOCK, OR OTHER PERSONAL INJURY, MOUNT FAN ONLY TO AN OUTLET BOX MARKED ACCEPTABLE FOR FAN SUPPORT AND USE THE MOUNTING SCREWS PROVIDED WITH THE OUTLET BOX. OUTLET BOXES COMMONLY USED FOR THE SUPPORT OF LIGHTING FIXTURES MAY NOT BE ACCEPTABLE FOR FAN SUPPORT AND MAY NEED TO BE REPLACED. CONSULT A QUALIFIED ELECTRICIAN IF IN DOUBT.**

Figures 1, 2, and 3 are examples of different ways to mount the outlet box.

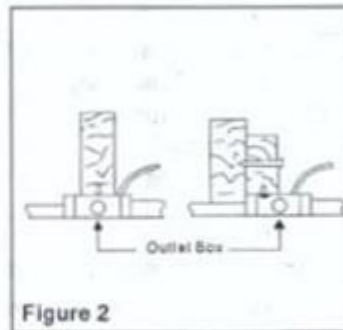
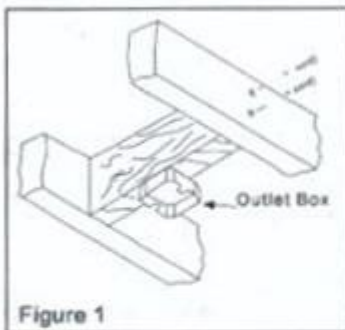

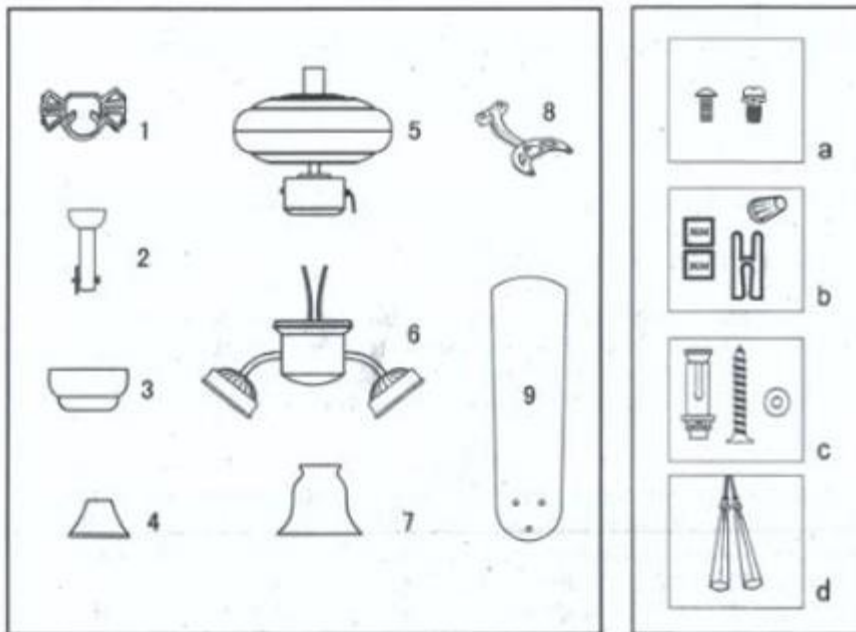

Unpack you fan and check the contents. You should have the following items:

1. Mounting Plate(Inside canopy)
  2. Downrod and Ball Assembly
  3. Canopy
  4. Decorative Motor Collar Cover
  5. Fan Motor Assembly
  6. Light Kit( optional )
  7. Glass shade
  8. Blade Bracket Set
  9. Blades
- a. Blade attachment hardware & Motor Screws
  - b. Balancing Kit Hardware & Electrical hardware (3 plastic wire connectors-wirenuts)
  - c. Expansion screws. screws and washer
  - d. Chain Pull

## Safety Precaution

1. Safety Rules-----	Page 1
2. Unpacking Your Fan-----	Page 2
3. Installing Your Fan-----	Page3
4. Operating Your Fan-----	Page10
5. Care Your Fan-----	Page11
6. Troubleshooting-----	Page11
7. Specifications-----	Page12

---

### IMPORTANT:PLEASE READ BEFORE INSTALLATION

1. Installation must be carried out by a qualified wiring installer
2. Turn off the electrical mains at the circuit breaker fuse box
3. Use power supply 220~240V 50Hz
- \*4. When mounting the fan, ensure that the safety cable is loop across the ceiling mounting hook.
5. The ceiling mounting hook must be able to with hold a min. of 35 pounds.
6. The ceiling fan must be mounted at a min. height of 2.3 meter of clearance from the floor.
7. Do not operate the reverse switch when the fan is still in motion. Wait till it stops completely before switching to reverse mode.
8. Do not place any objects in the path of the blades.
9. When all electrical connections are done, store all wires neatly.
10. Make sure that all screws and connection are tightly screwed and secure

### WARNING

TO REDUCE THE RISK OF PERSONAL INJURY. DO NOT BEND THE BLADE BRACKETS DURING ASSEMBLY OR AFTER INSTALLATION. DO NOT INSERT OBJECTS THE PATH BLADES.

### WARNING

TO REDUCE THE RISK OF SHOCK. THIS FAN MUST BE INSTALLED WITH AN ISOLATION WALL CONTROL/SWITCH

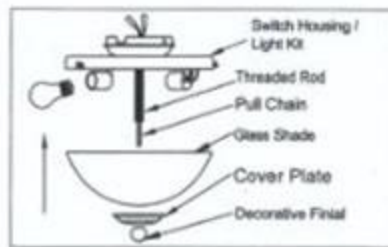
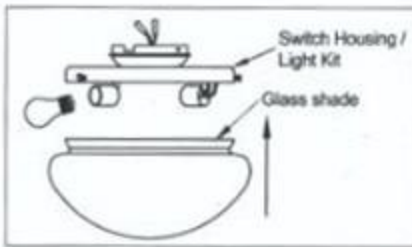

This procedure is fit for installing one light kit and using E27 lamp .

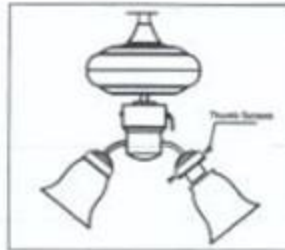

This procedure is fit for installing the light kit which the lamp-socket is connected on the switch cover ,such as the light kit with three or four lamp-socket. And using E27 lamp .

- Carefully push all wires back into switch housing of fan. Then replace the cover with original screws.
- Install 25 watt(max.)bulb(not provided )  
Tighten three thumb screws provided on the fitter Gently.Donot over tighten.
- Open the power source then your light kit is ready for working .

Earth wire is longer above 60mm than safety cord.When failure of the suspension system occurs,the current-carrying conductor taut before earthing conductor and thd body of the fan assembly is still effectively earthed.