

# INSTALLATION MANUAL

## MAIN CABINET VMC1066NWA24

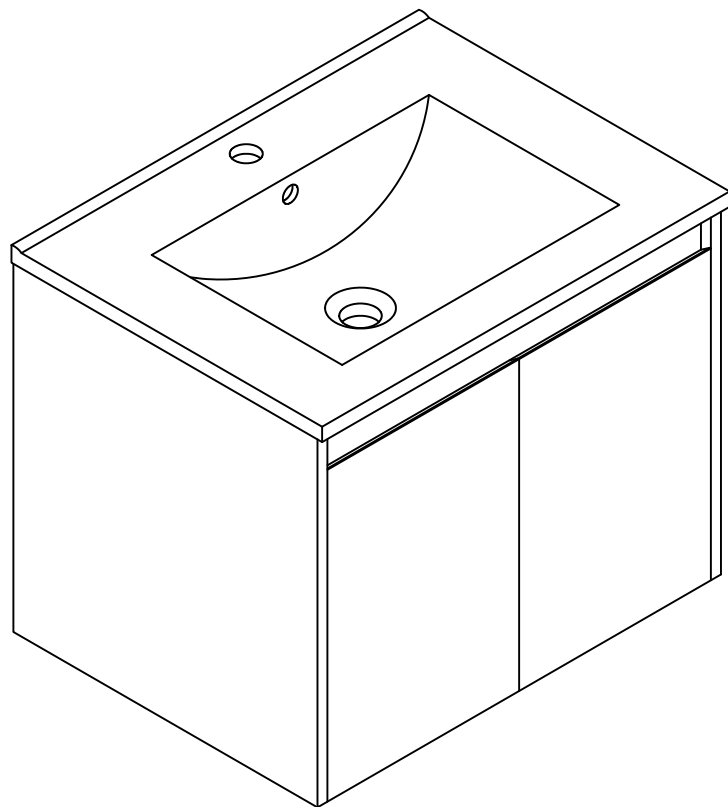

NOTE: The sink is packed separately.

MORVANO®

## WARNING

Serious or fatal crushing injuries can occur from furniture falling down. To prevent this furniture from falling down it must be used with the wall attachment device(s) provided.





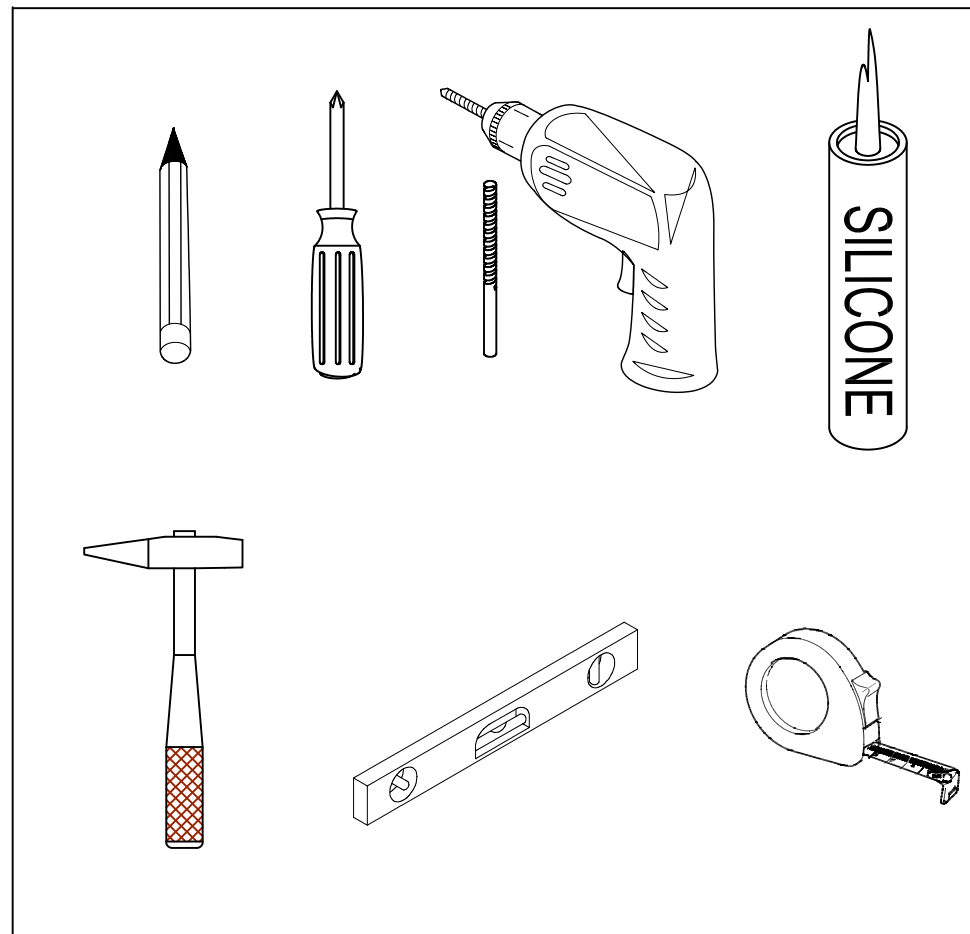

This cabinet must be mounted to a solid structural wall (e.g., concrete, wood stud, or solid tile backing). **Do not install on hollow drywall or unsupported tile surfaces.**

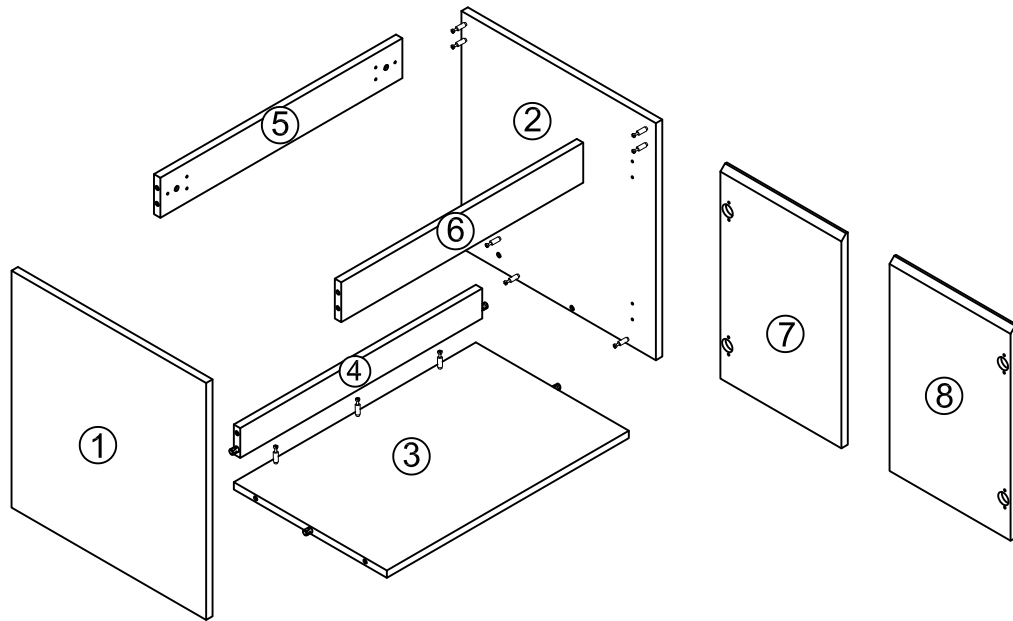





## Recommended Tools



# Assembly Parts Overview



NO.	Part Name	QTY
A	 Screw Ø4 x 14 mm	44
B	 Cam Bolt	17
C	 Cam Lock	17
D	 Wooden Dowel	4
E	 Wall Anchor Ø10mm	2
F	 Wall Mounting Screw	2

NO.	Part Name	QTY
G	 Screw Cap Cover	2
H	 Bracket 53x70x44mm	2
I	 Bracket 19x19x35mm	2
J	 Concealed Hinge	4
K	 Door Bumper Pad	4
L	 Screwdriver	1

# Cam Lock Assembly Instructions

Diagram A

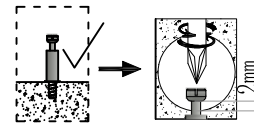

Insert Cam Bolt into hole as shown in diagram A.

Diagram B

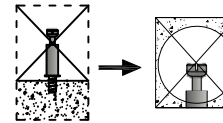

Also avoid inserting the Cam Bolt too close to the surface of the hole as shown in figure B, as this will cause the Cam Lock to be too loose, and not interlock properly.

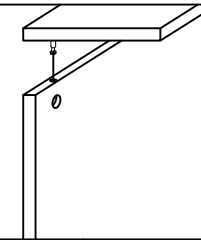

Connect the panels together.

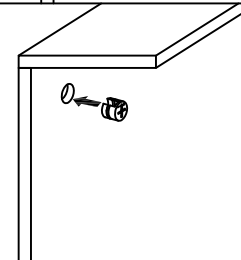

Attention: Cam lock arrow point to the steel rod.

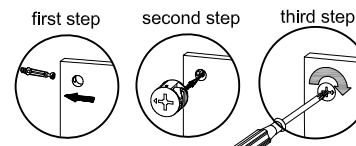
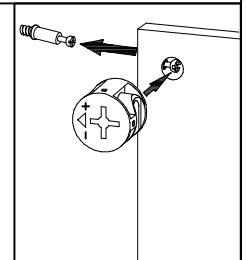



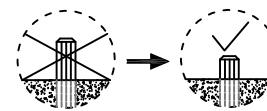

To tighten the Cam Lock, turn it clockwise on half a turn with a flat screwdriver. Do not use an automatic screwdriver as it may bend or break if too much power is imposed.

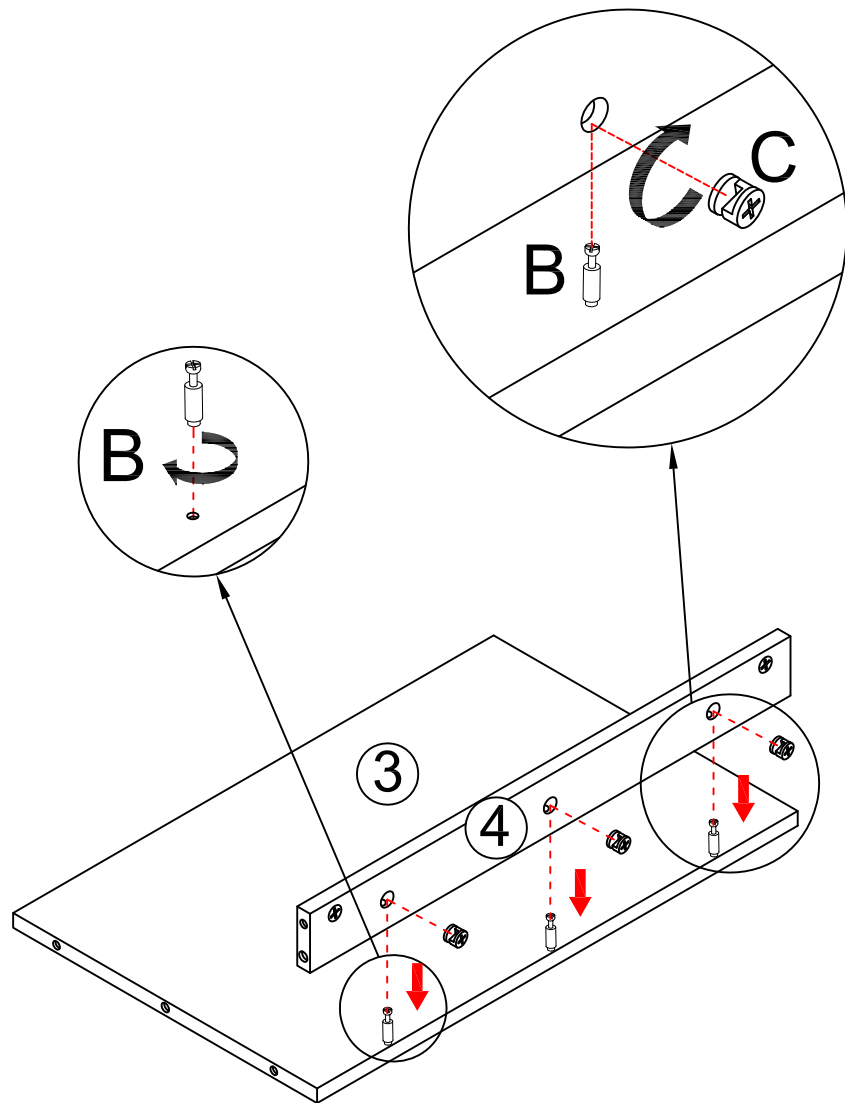

Installation of wooden dowels as shown in the diagram.





Step 1

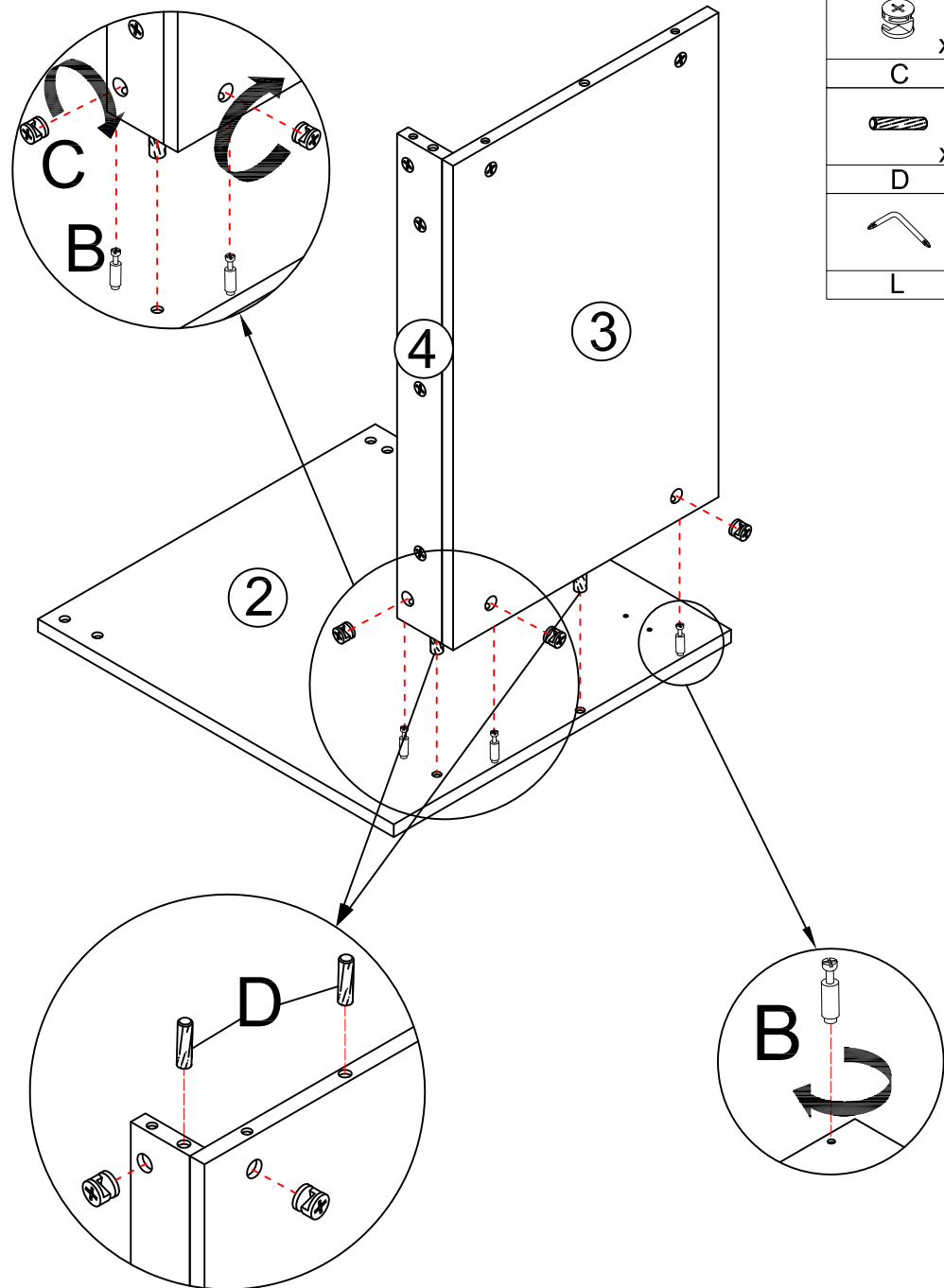

-  x3
- B**
-  x3
- C**
- 
- L**





Step 2

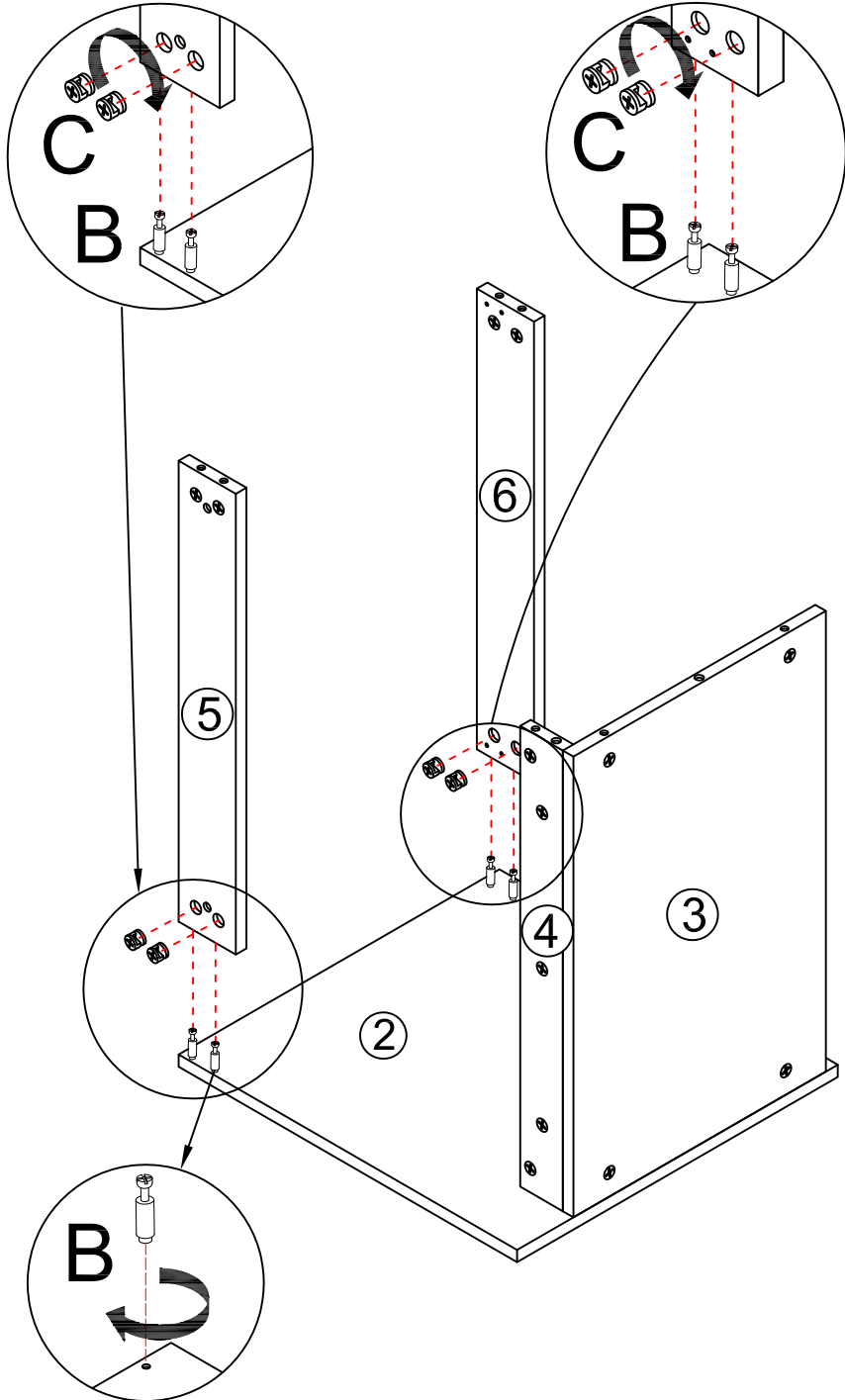

-  x3
- B**
-  x3
- C**
-  x2
- D**
- 
- L**







Step 3

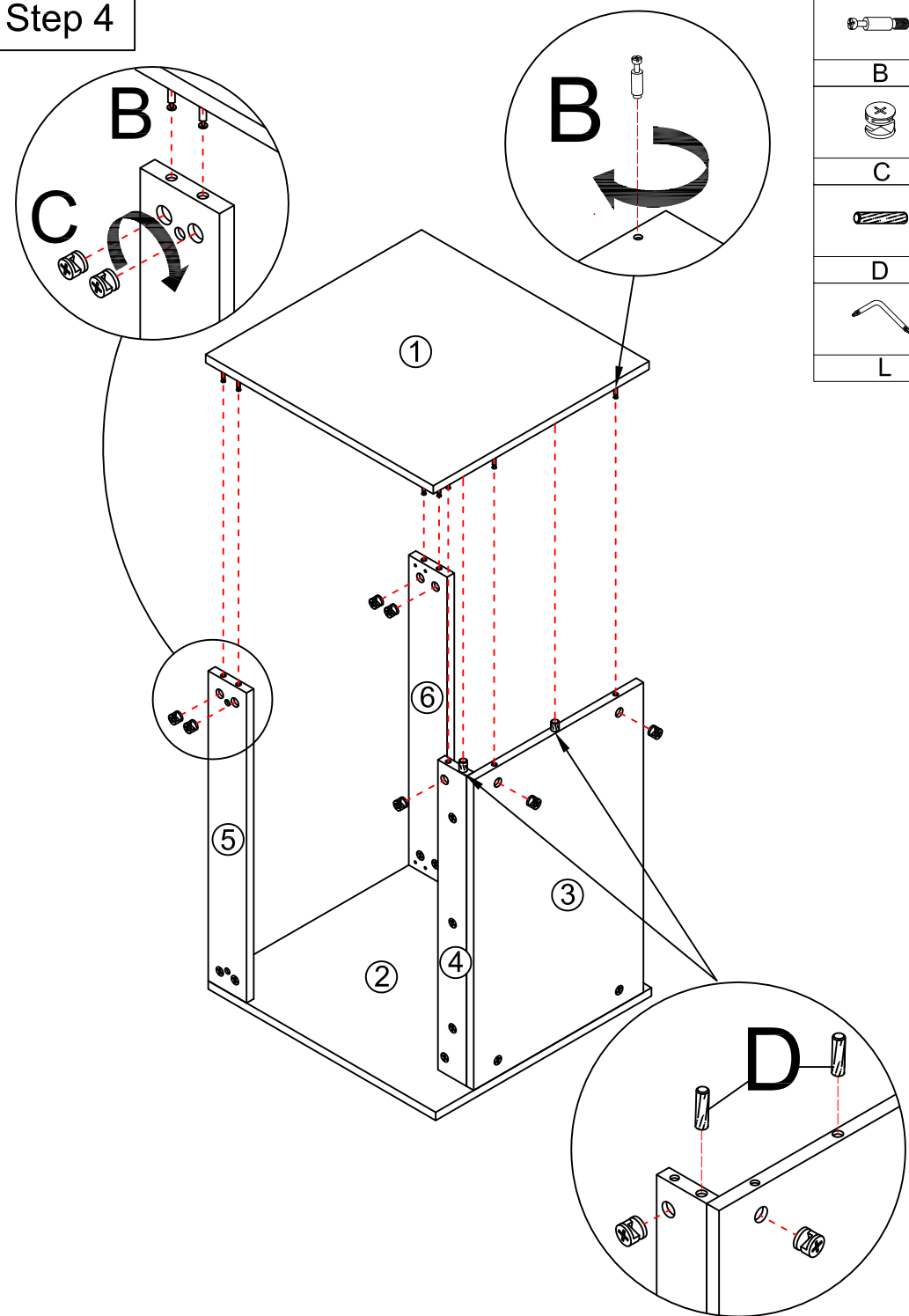

-  x4
-  x4
- 
- 





Step 4

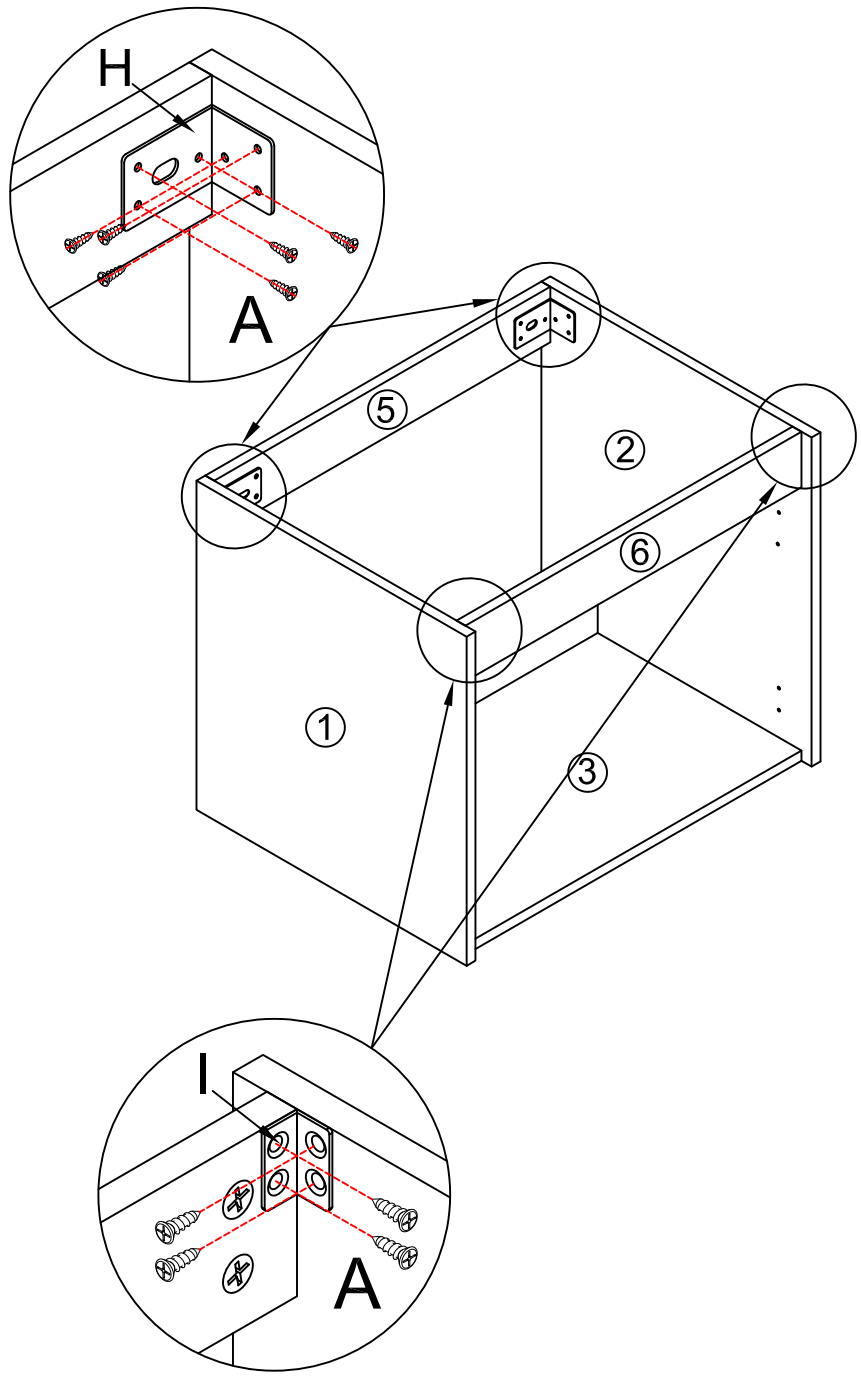

-  x7
-  x7
-  x7
-  x2
- 
- 





# Step 5

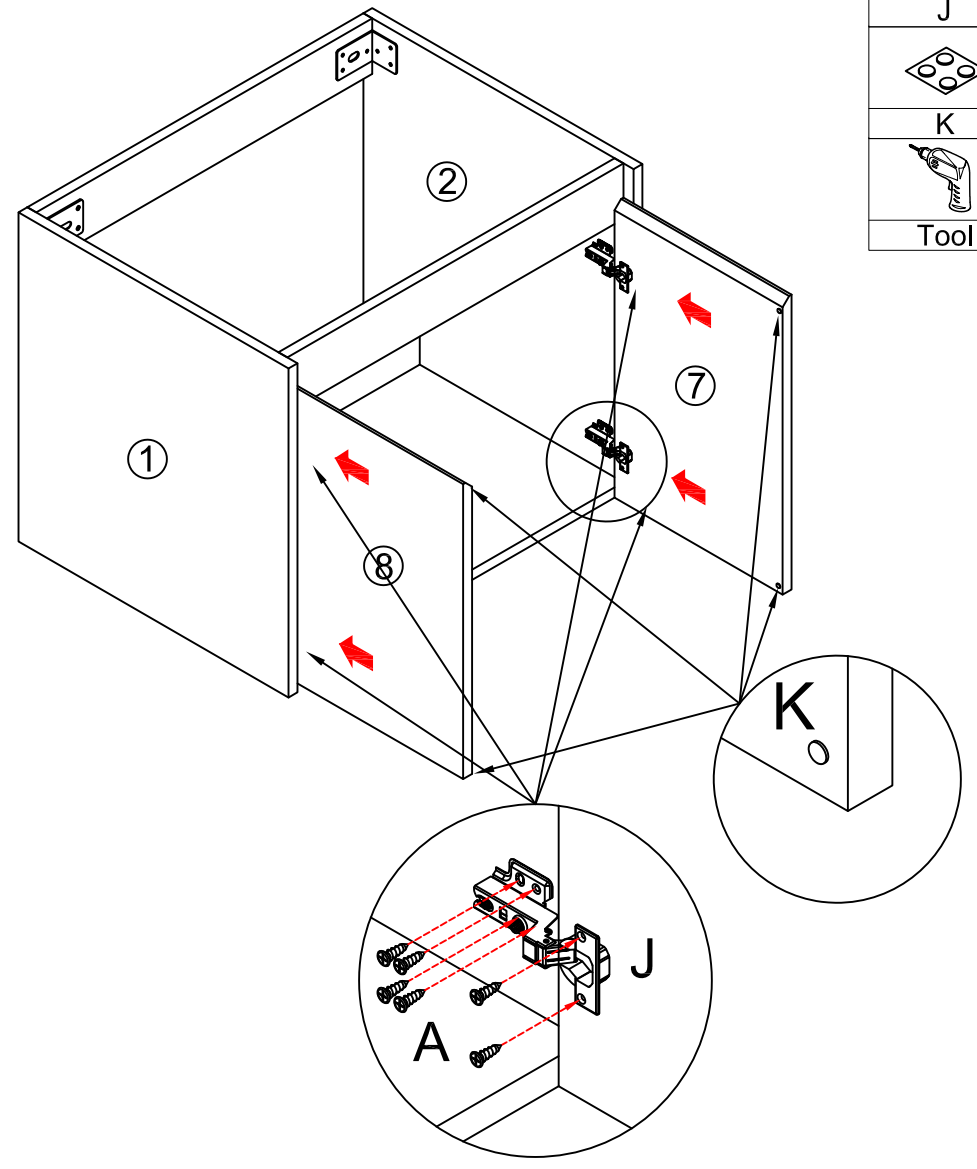

-  x20
- A
-  x2
- H
-  x2
- I
-  Tool

# Step 6



-  x24
- A
-  x4
- J
-  x4
- K
-  Tool

The door hinges are adjustable to ensure proper alignment. See page 14 for detailed instructions.

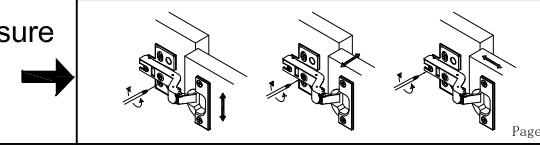

Step 7

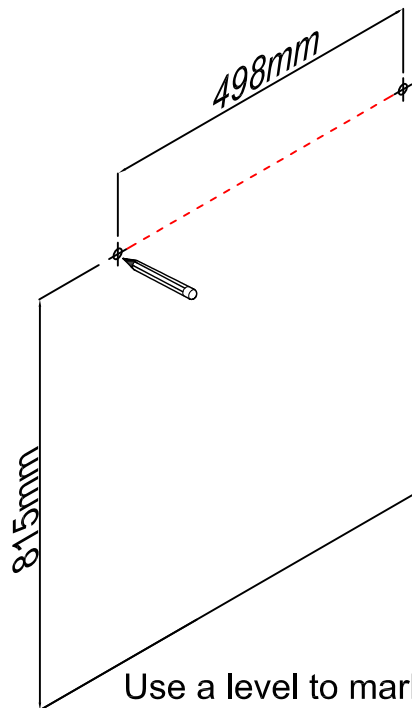

Tool



Tool



Tool

Step 9



E



Tool

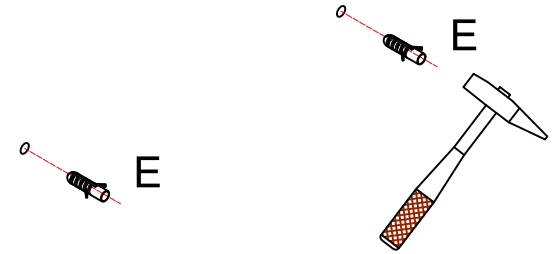

Use a level to mark two horizontally aligned holes at the indicated height and spacing.

Step 8

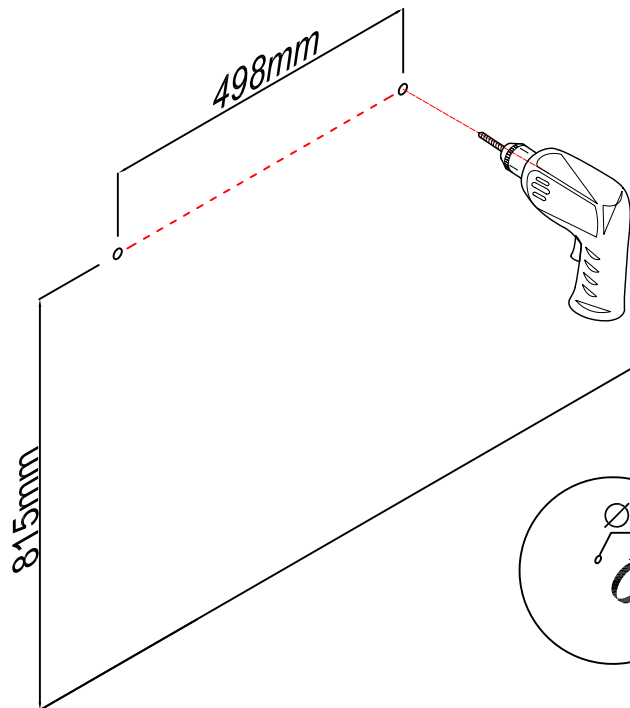

Tool

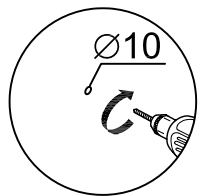

Step 10

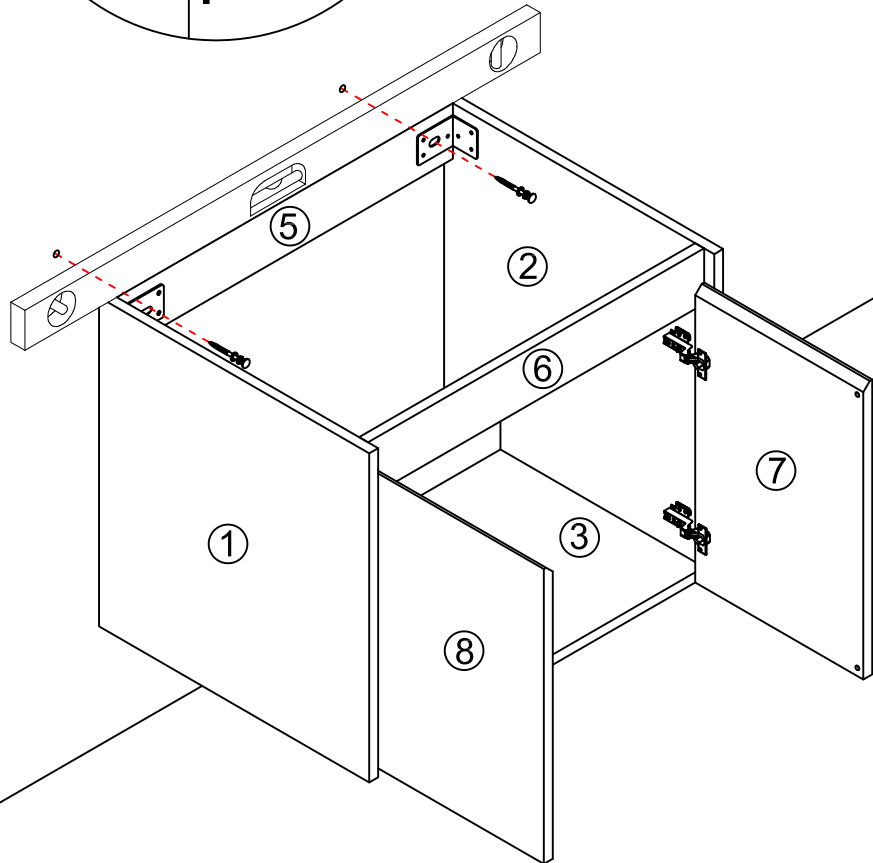
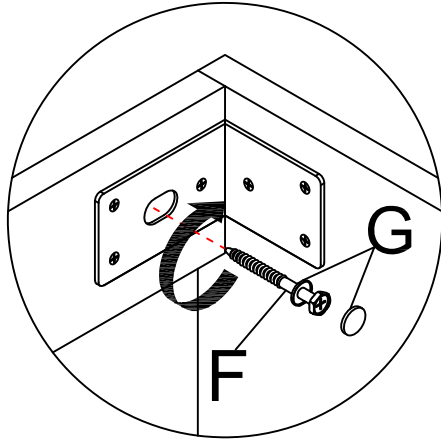

F

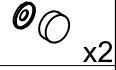

G



Tool



Tool

Finished



SILICONE

Tool

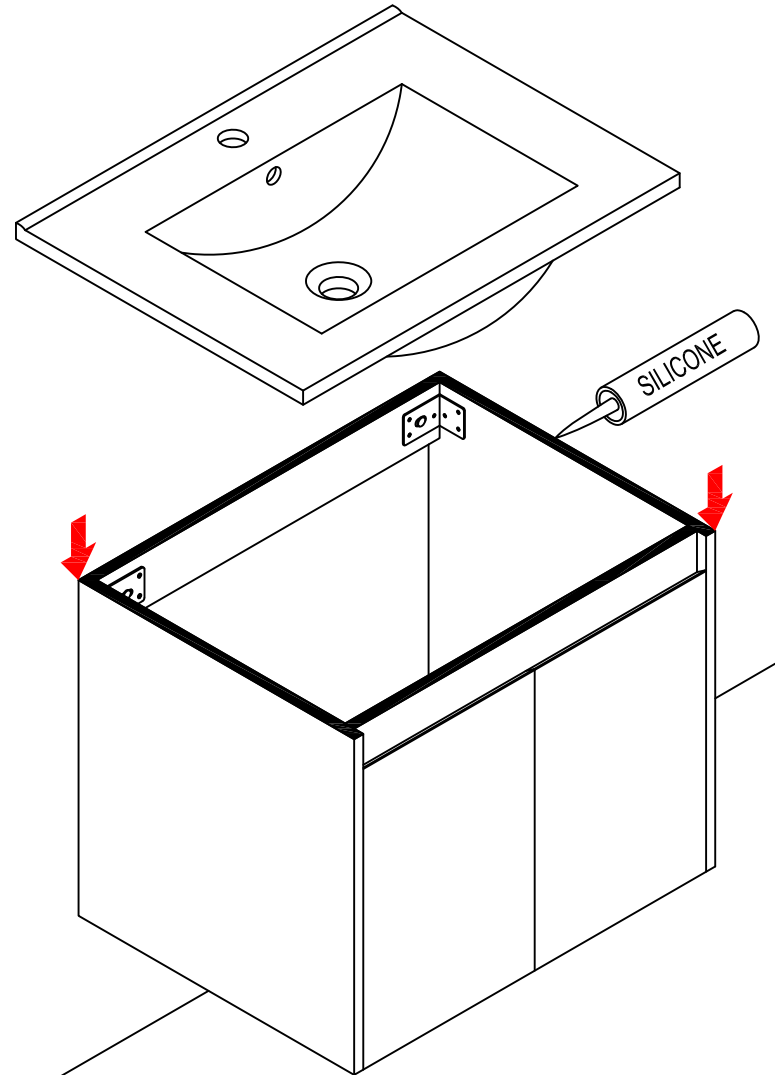

# ADJUSTING THE DOORS

- Up and down  
Remove screws (B&D) from the hinge.  
Turn screws (A&C) in or out to raise or lower the door.  
Reinstall screws (B&D) after adjustment.

Left Door (Interior View)    Right Door (Interior View)

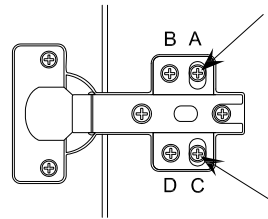
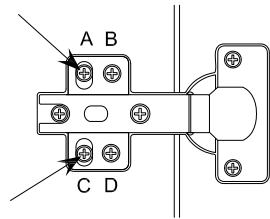
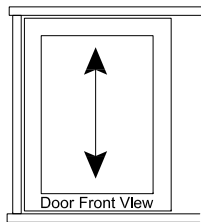

- Left and right  
To adjust the door side-to-side, turn screw (F) in or out.

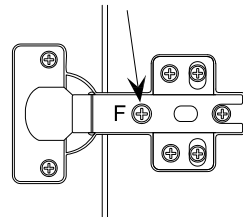
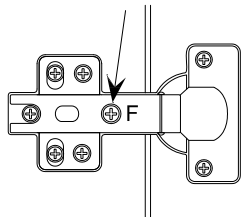
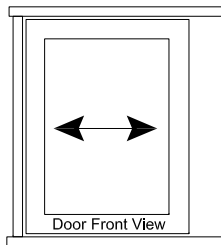

- In and out  
To adjust the door depth, turn screw (E) in or out.

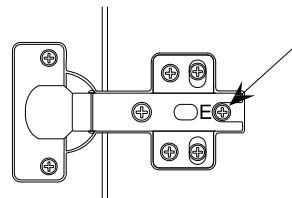
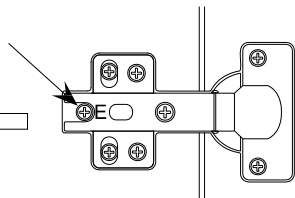
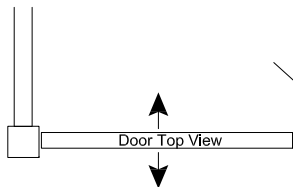

# MORVANO<sup>®</sup>

Thank you for choosing Morvano.

Please do not hesitate to contact us if you have any questions or concerns.

Email: [mvn-service@outlook.com](mailto:mvn-service@outlook.com)