

2. Install Crystal

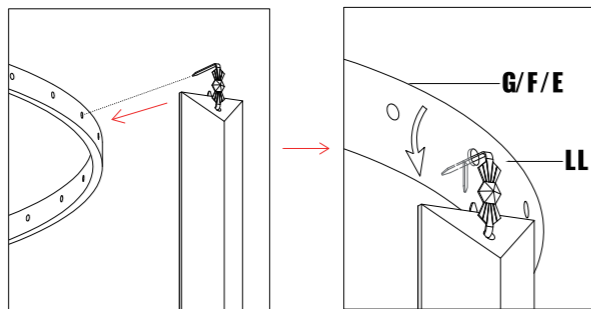
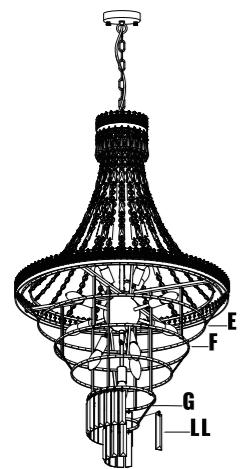
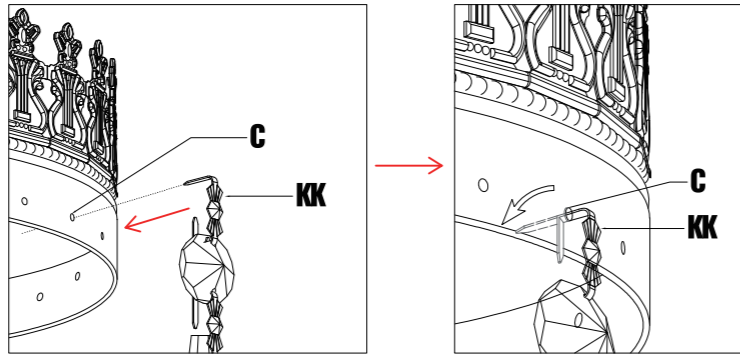
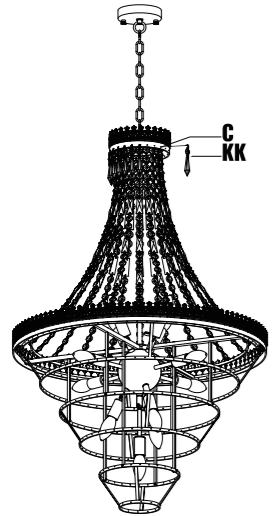
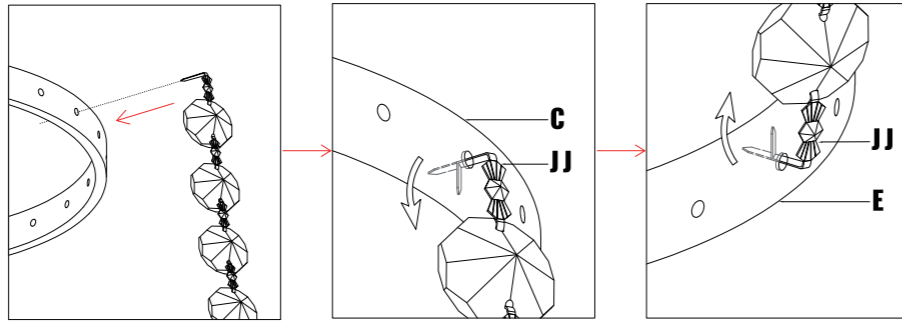
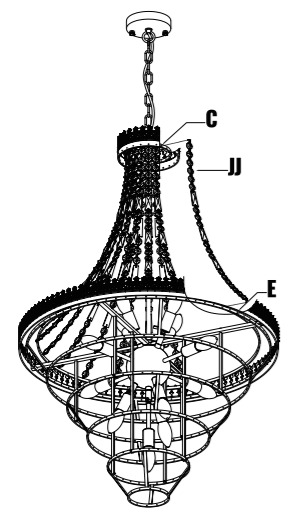

STEP 1: Insert the Butterfly Clips at both ends of the Long Crystal Strand (JJ) into the inner ring holes of Lamp Body ① (C) and Lamp Body ② (E) and secure them as shown.

STEP 2: Fix the Short Crystal Strand (KK) on Lamp Body ① (C).

STEP 3: Hang Rectangle Crystal (LL) from bottom to top on G/F/E in sequence.

INSTALLATION MANUAL

CHANDELIER

Model No.: HLP447BG-12A

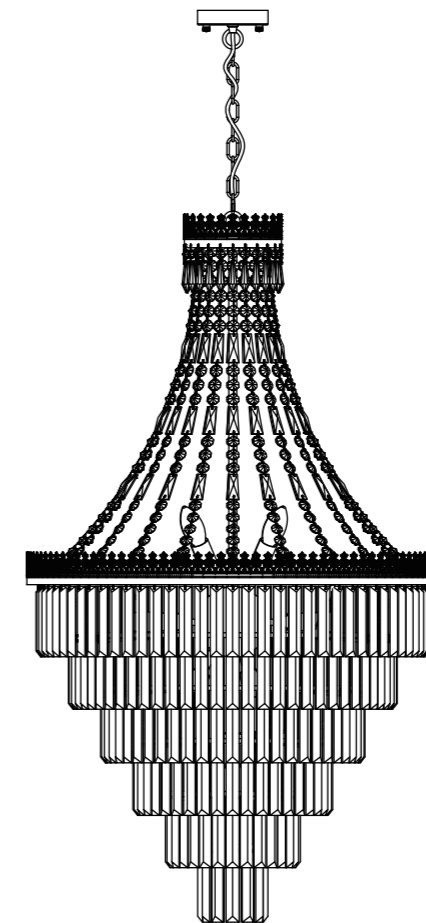

TOOLS REQUIRED



Ladder

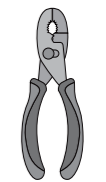

Pliers

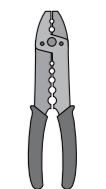

Wire Strippers

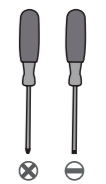

Screwdrivers







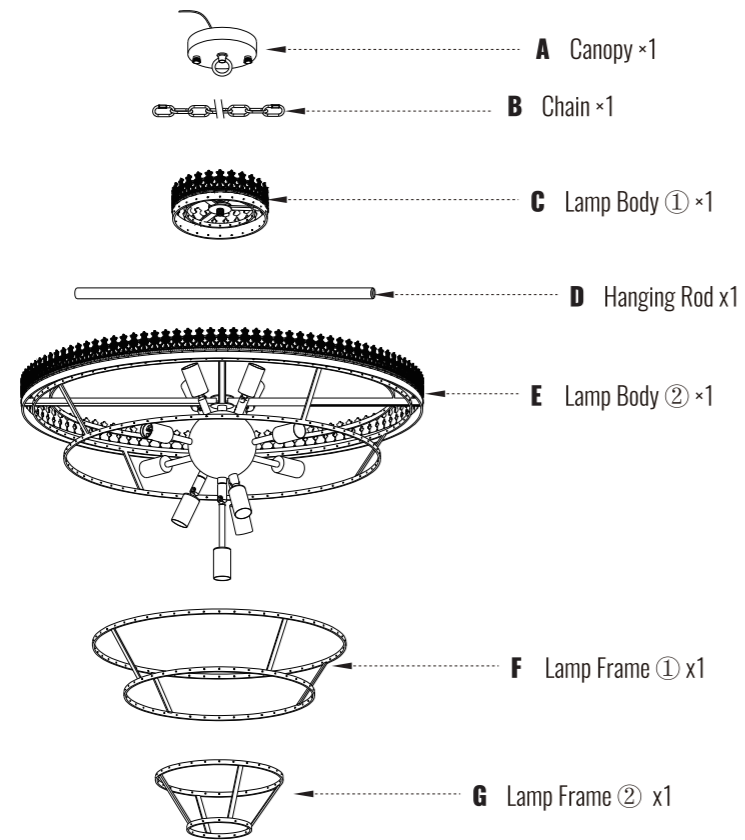



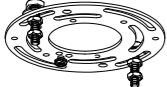



Scan for Installation Video

PACKING LIST

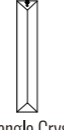

INSTALLATION KIT

AA  Mounting Bracket	1×	BB  Outlet Box Screw	2×	CC  Cap Nut	2×
DD  Ground Screw	1×	EE  Wire Nut	3×	FF  M5 Screw	8×
GG  M3 Screw	8×	HH  Short Rod	4×	II  Long Rod	4×
JJ  Long Crystal Strand	21×	KK  Short Crystal Strand	25×	LL  Rectangle Crystal	280×
		MM  Gloves			1×

NOTE:

- JJ/KK/LL have some extra pieces for back-up.
- AA/CC/DD has already been pre-installed with Canopy (A).
- FF/GG has already been pre-installed together with HH/II.

INSTALLATION

1. Install Lamp Body

(1)

FF
HH/II
GG

(2)

FF
E
HH
GG
F

(3)

FF
E
II
GG
G

STEP 1: Loosen the FF/GG from HH/II.

STEP 2: Use the Short Rod (HH) to install the Lamp Frame ① (F) on Lamp Body ② (E), and fix it with M5 Screw (FF) and M3 Screw (GG).

STEP 3: Use the Long Rod (II) to install the Lamp Frame ② (G) on Lamp Body ② (E), and fix it with M5 Screw (FF) and M3 Screw (GG).

2. Install Hanging Rod

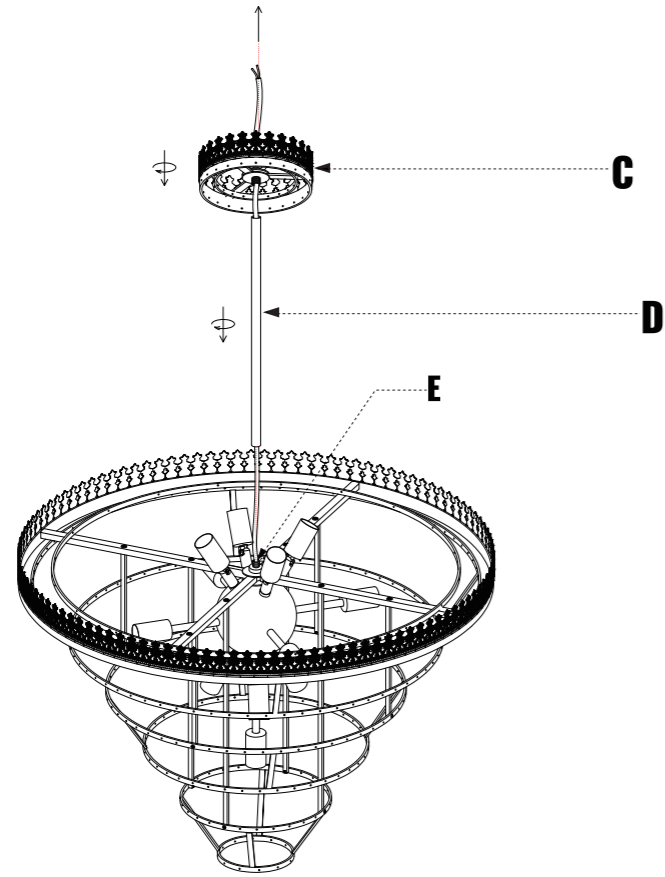

STEP 1: Pass the power cord of the Lamp Body ② (E) through the Hanging Rod (D) and Lamp Body ① (C) as shown.
STEP 2: Tighten Lamp Body ① (C) and Lamp Body ② (E) to Hanging Rod (D).

3. Remove the Mounting Bracket

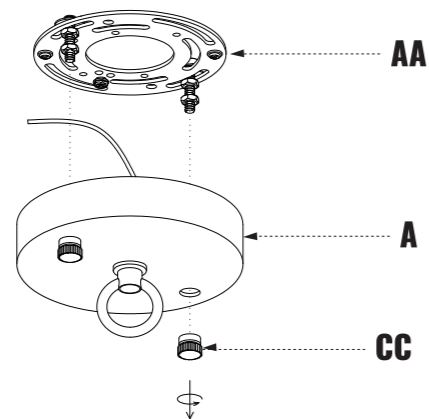

Loosen the Knurled Nut (CC) from Canopy (A), take out the Mounting Bracket (AA).

4. Install Chain

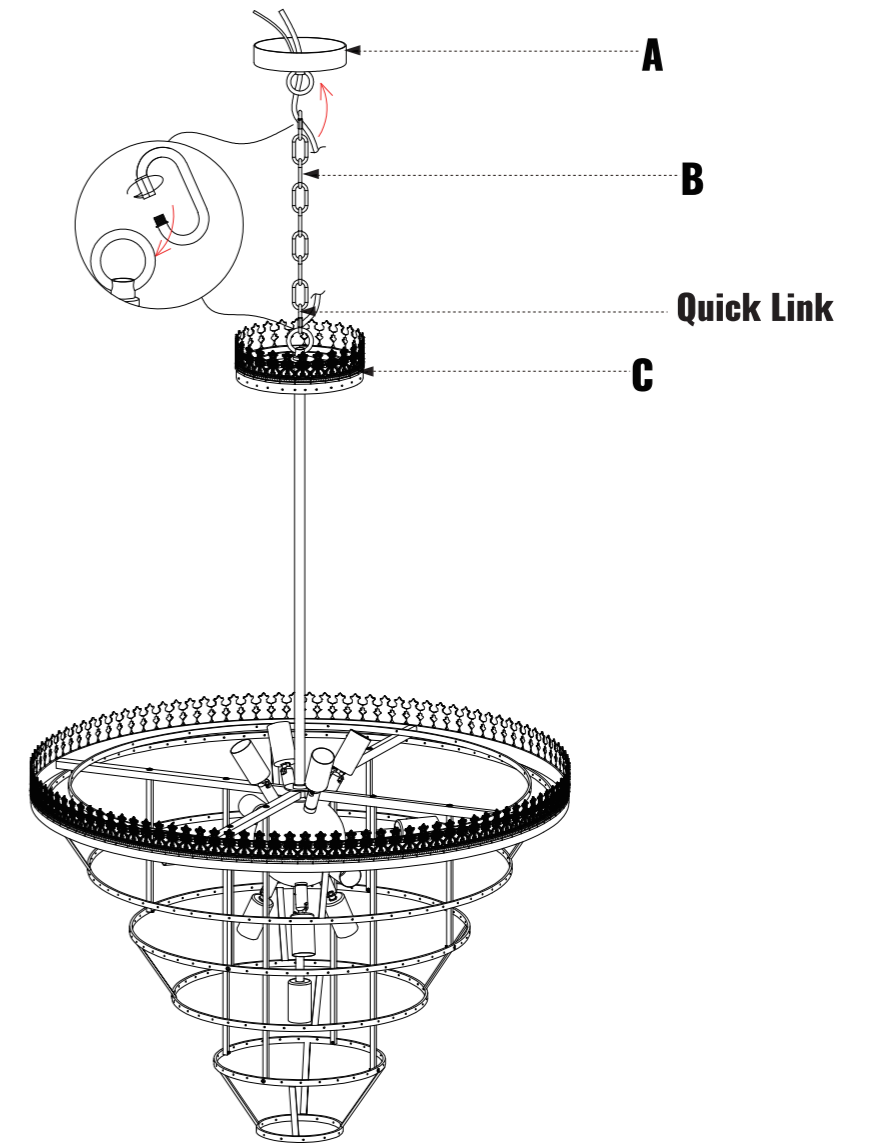

STEP 1: Pass the power cord through the Chain (B) and Canopy (A).

STEP 2: Open the Quick Link on Chain (B), then connect the Quick Link on both ends of Chain (B) to the Canopy (A) and Lamp Body ① (C), and finally lock the Quick Link tightly.

MOUNTING AND WIRE

1. Install the Mounting Bracket

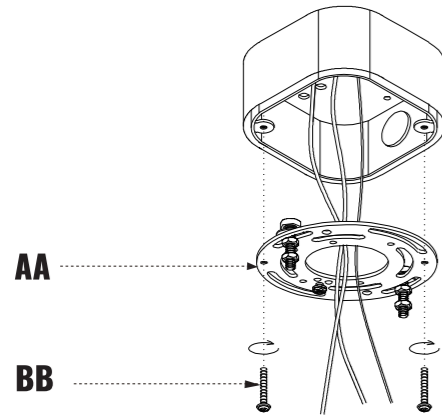

Take off the screws from outlet box, attach the Mounting Bracket (AA) to the box with screws taken off or Outlet Box Screw (BB).

2. Connect the Wires

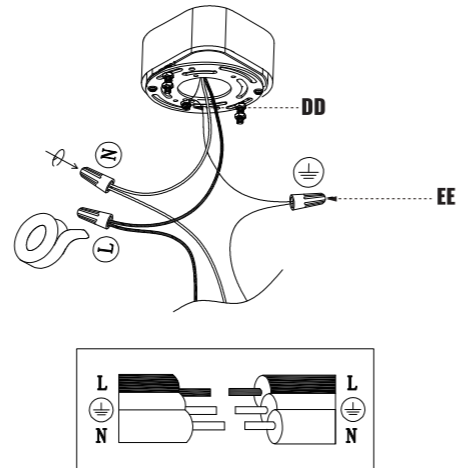

STEP 1: Wrap the ground wire from the outlet box around the Ground Screw (DD) on the Mounting Bracket (AA), and then connect the ground wire from the fixture to the ground wire from the outlet box.

STEP 2: Connect the wires from the fixture to the house supply wires, neutral wire (white) to neutral wire, and hot wire (black) to hot wire.

STEP 3: Spread apart the wires so that the hot wires are on one side of the outlet box and the neutral wires are on the other side.

3. Fix the Canopy

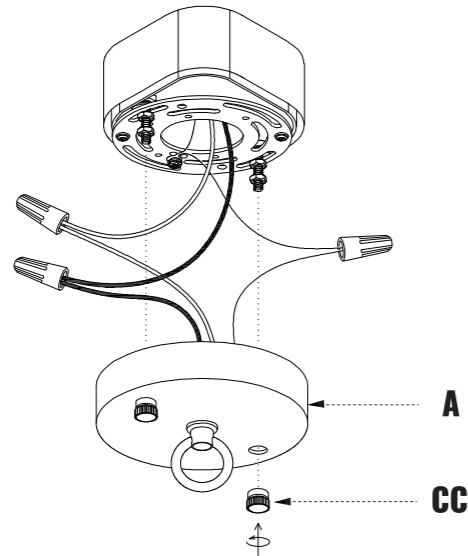

Fix the Canopy (A) onto the Mounting Bracket (AA) with Cap Nuts (CC).

INSTALL CRYSTAL AND BULBS

1. Install Bulbs

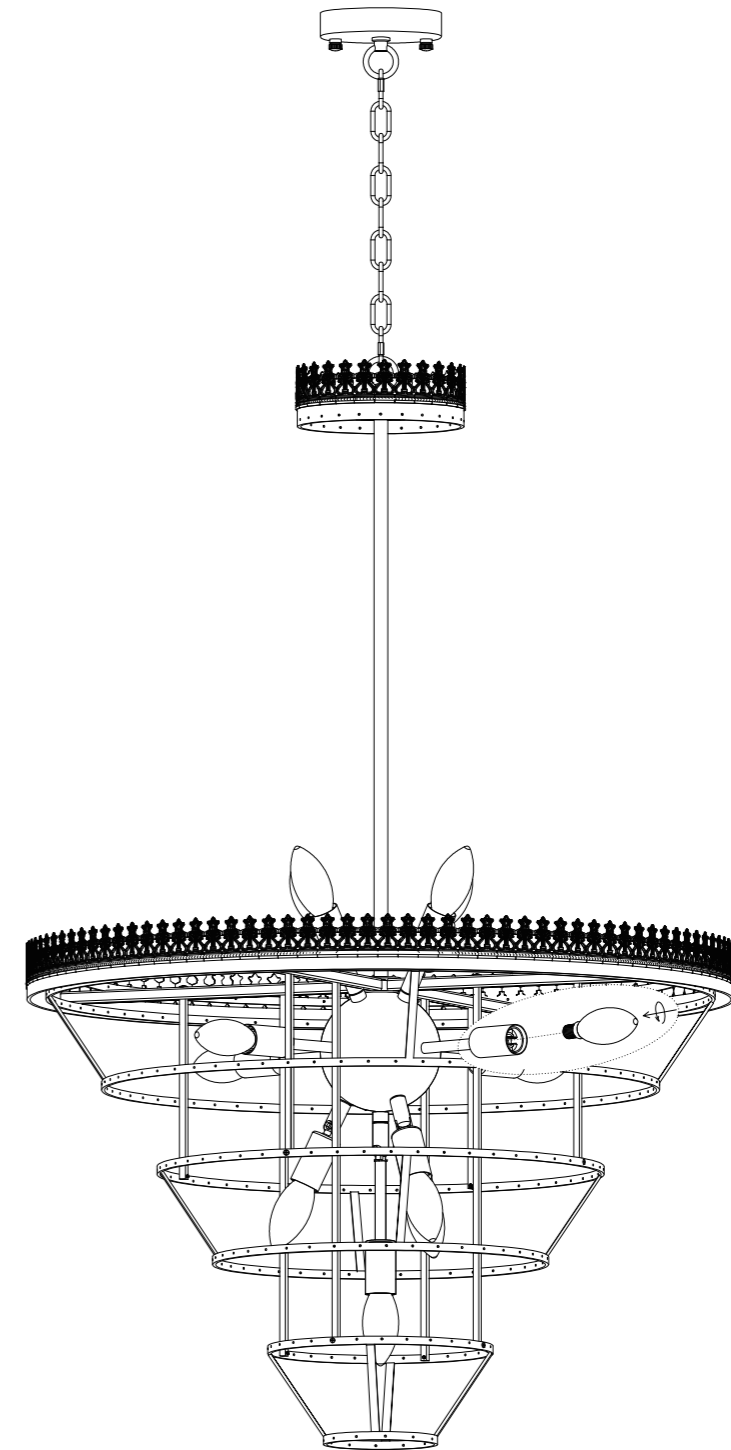

E12 Bulbs X 12
(Max 40W each, not included)

NOTE:

This lamp uses E12 bulbs up to 40W. Fully dimmable when used with dimmable bulbs and compatible dimming switches (not included).