

# ASSEMBLY INSTRUCTIONS

## TOOLS REQUIRED



Screwdriver  
( Not included)



(Included)  
Allen Wrench



2 - People

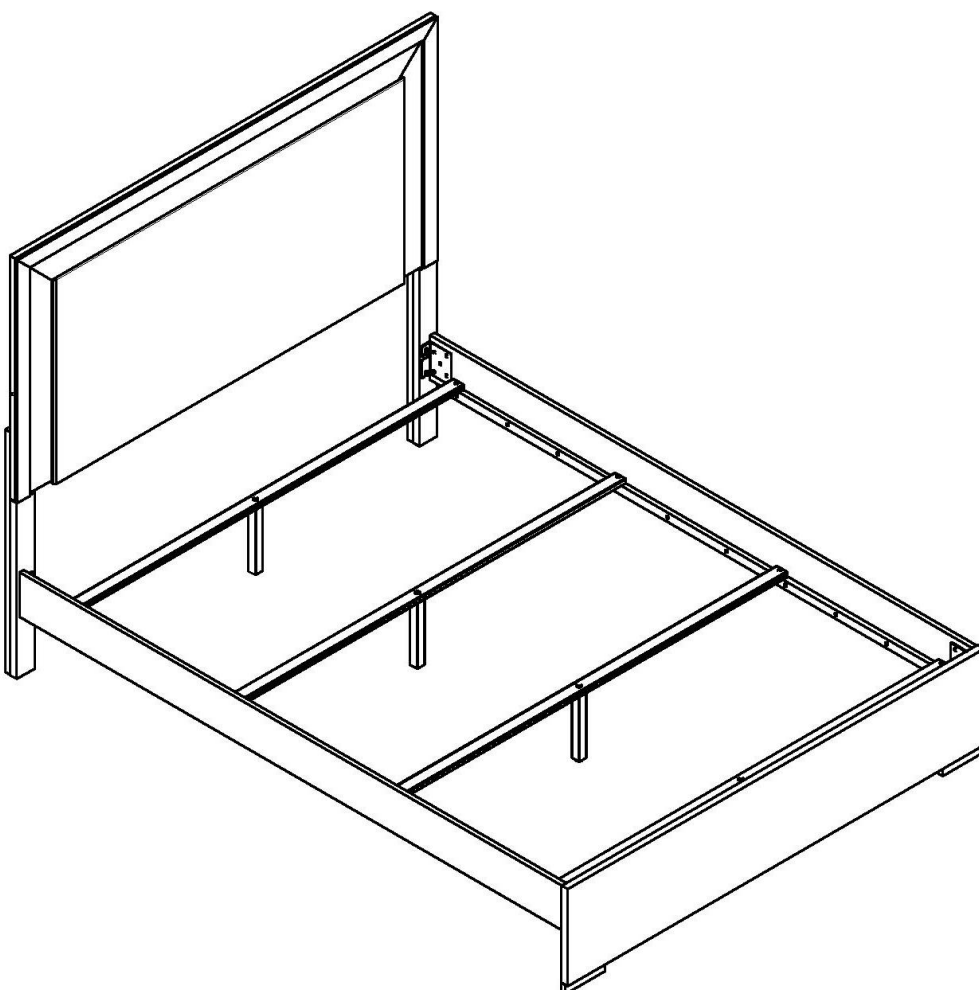

## ASSEMBLY RATING

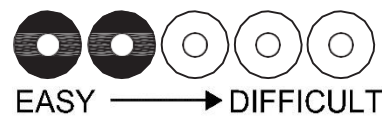

The Assembly Rating is a 5-point system showing the level of effort needed to assemble a specific product.



## **CHECK BEFORE STARTING**

### **Are you missing anything?**

Double-check all parts, hardware and accessories listed are all accounted for.

### **Check out our Quick Tips!**

We recommend reviewing the pre-assembly handouts. Even experts need a refresher now and then!

### **Should we send any replacements?**

Are there any irregularities or flaws in the parts? We can send replacements!

### **Prep Time!**

Please review the assembly instructions and all diagrams prior to assembling.

# PRE ASSEMBLY INTRODUCTION

We understand building ready-to-assemble furniture can be a challenging experience for some. To help avoid confusion, we have provided some helpful tips that may speed up the process.



## Teamwork

ALWAYS have at least two people to help with transporting and assembling the product to avoid potential injury and/or damage.



## Suitable Location

Assembling near the area of the intended location is highly recommended.



## Sufficient Space

Make sure you have enough space to move around during the assembly.



## Avoid Scratches

Use cardboard, blankets or a carpeted area while assembling furniture to prevent to prevent scratches and damages.

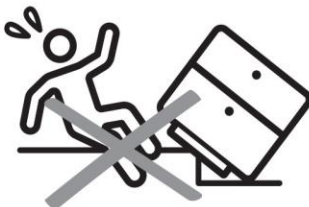

## Flat Surface

Make sure the furniture rests on a flat and level surface with each leg evenly touching the floor.

# ASSEMBLY AND CARE ADVICE



**FAILURE TO FOLLOW THE GUIDELINES BELOW MAY RESULT IN INJURY AND/OR PROPERTY DAMAGE.**



Position each part correctly and insert screws or bolts into their respective holes.



Turn clockwise to tighten and only tighten when step is completed or when instructed to do so.



Use the appropriate hand tools or power tools for assembly. Select steps, such as tightening screws and/or bolts, may require hand tools to avoid causing damage during assembly.



Save the instructions and store any supplied tools for later maintenance.



After two weeks, check and tighten any loose hardware and repeat again every six months thereafter.

**IT IS THE USER'S RESPONSIBILITY TO MAINTAIN THE FURNITURE. THE HARDWARE MAY LOOSEN OVER TIME AND MAY CAUSE THE FURNITURE TO BE WOBBLY AND UNABLE TO SUPPORT ITS INTENDED WEIGHT CAPACITY. THIS MAY LEAD TO COLLAPSE AND MAY CAUSE SERIOUS INJURY.**

# QUEEN BED



- Please keep instructions for future reference.
- Check the quantity and irregularity of parts and hardware before you start.

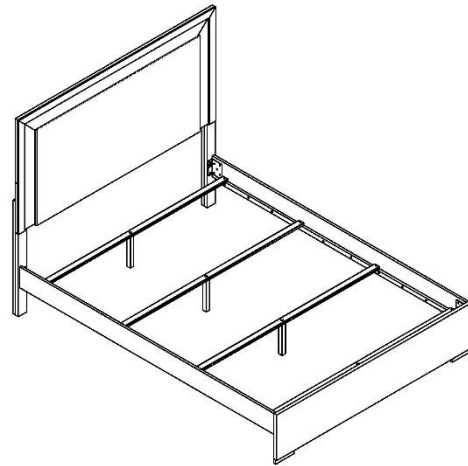

## PARTS

① 1pc

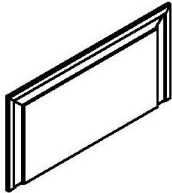

HEADBOARD

② 1pc

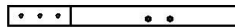

HB - LEG RIGHT

③ 1pc

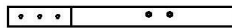

HB - LEG LEFT

④ 1pc

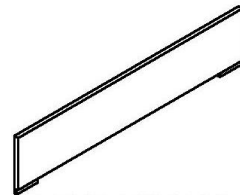

FOOTBOARD

⑤ 2pcs

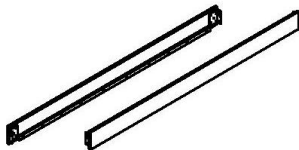

SIDE RAIL

⑥ 4pcs

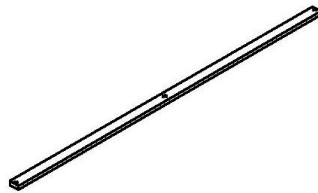

SLAT  
1540 x 42 x 17mm

⑦ 4pcs

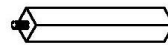

VERTICAL LEG  
219 x 29 x 29mm

## HARDWARE

### HARDWARE INSIDE HEADBOARD

Ⓐ 6pcs



Bolt M8x40mm

Ⓑ 6pcs



Lock Washer

Ⓒ 6pcs

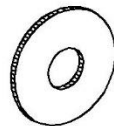

Flat Washer

Ⓓ 1pc



Allen Key M5

Ⓔ 1pc

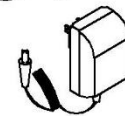

Adapter

### HARDWARE INSIDE FOOTBOARD

Ⓕ 8pcs



Bolt M8x20mm

Ⓖ 8pcs

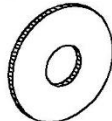

Flat Washer

Ⓓ 1pc







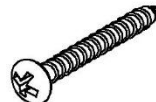



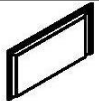





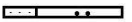

Allen Key M5

Ⓖ 8pcs

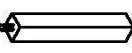

Panhead Screw  
M4x30mm

CARTON	DESCRIPTION	PART	HARDWARE
	QUEEN HEADBOARD	①  x1	 A x 6 PCS  B x 6 PCS  C x 6 PCS  D x 1 PC  E x 1 PC
	QUEEN HB - LEG RIGHT	②  x1	
	QUEEN HB - LEG LEFT	③  x1	
	QUEEN FOOTBOARD	④  x1	 F x 8 PCS  G x 8 PCS  D x 1 PC  H x 8 PCS
	QUEEN SLAT	⑥  x4	
	QUEEN VERTICAL	⑦  x4	
	QUEEN/KING SIDE RAIL	⑤  x2	

# ASSEMBLY INSTRUCTIONS

## 1

- Part ① 1pc
- Part ② 1pc
- Part ③ 1pc
- Hardware ①A 6pcs
- Hardware ①B 6pcs
- Hardware ①C 6pcs
- Hardware ①D 1pc

Use Allen Key (#D) to attach the HB Leg Right (#2) and HB Leg Left (#3) to the Headboard (#1) by using Bolt (#A) with lock washer (#B) and flat washer (#C).

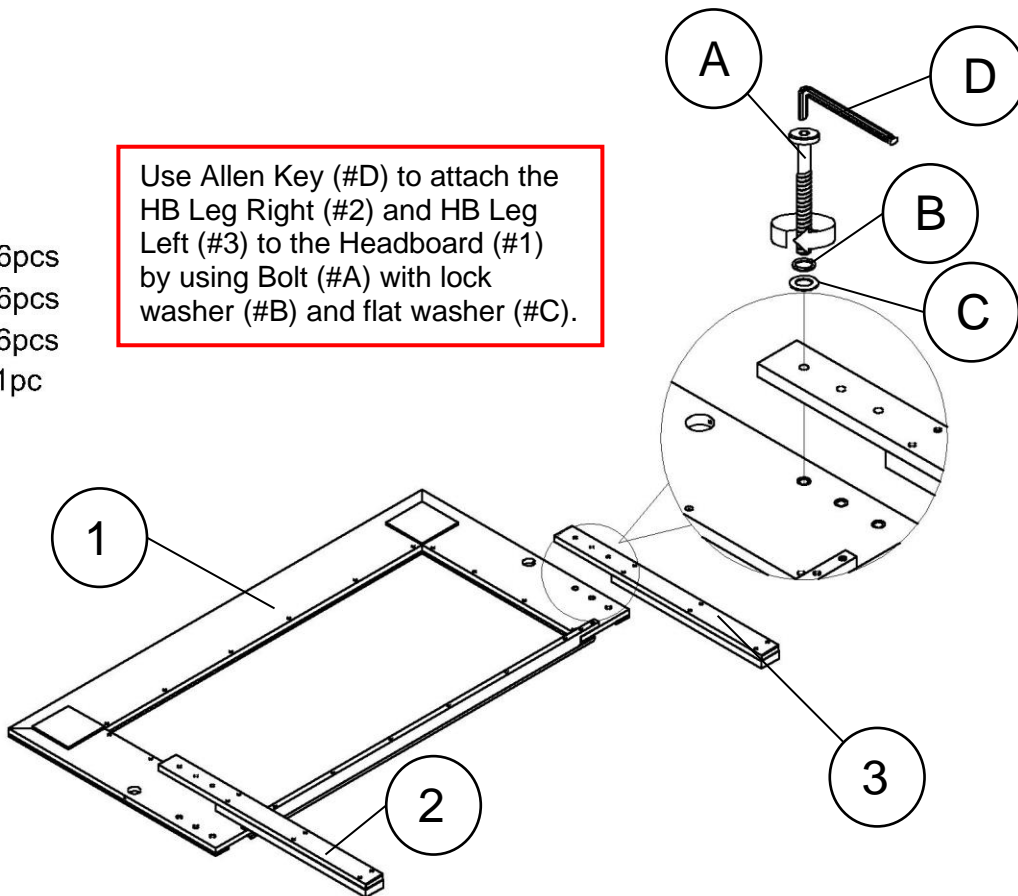

## 2

- Part ④ 1pc
- Part ⑤ 2pcs
- Hardware ②F 8pcs
- Hardware ②G 8pcs
- Hardware ②D 1pc

Use Allen Key (#D) to attach the Side rail (#5) to Headboard (#1) and Footboard (#4) by using Bolt (#G) with flat washer (#F).

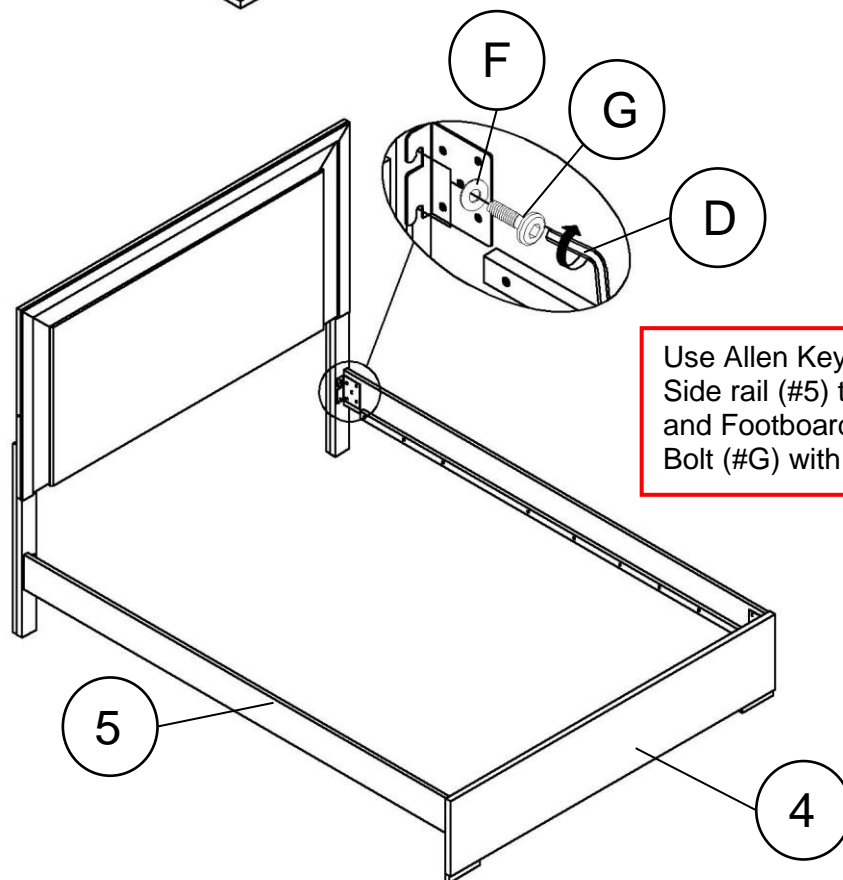

# ASSEMBLY INSTRUCTIONS

## 3

Part 6: 4pcs

Part 7: 4pcs

Hardware E: 1pc

Hardware H: 8pcs

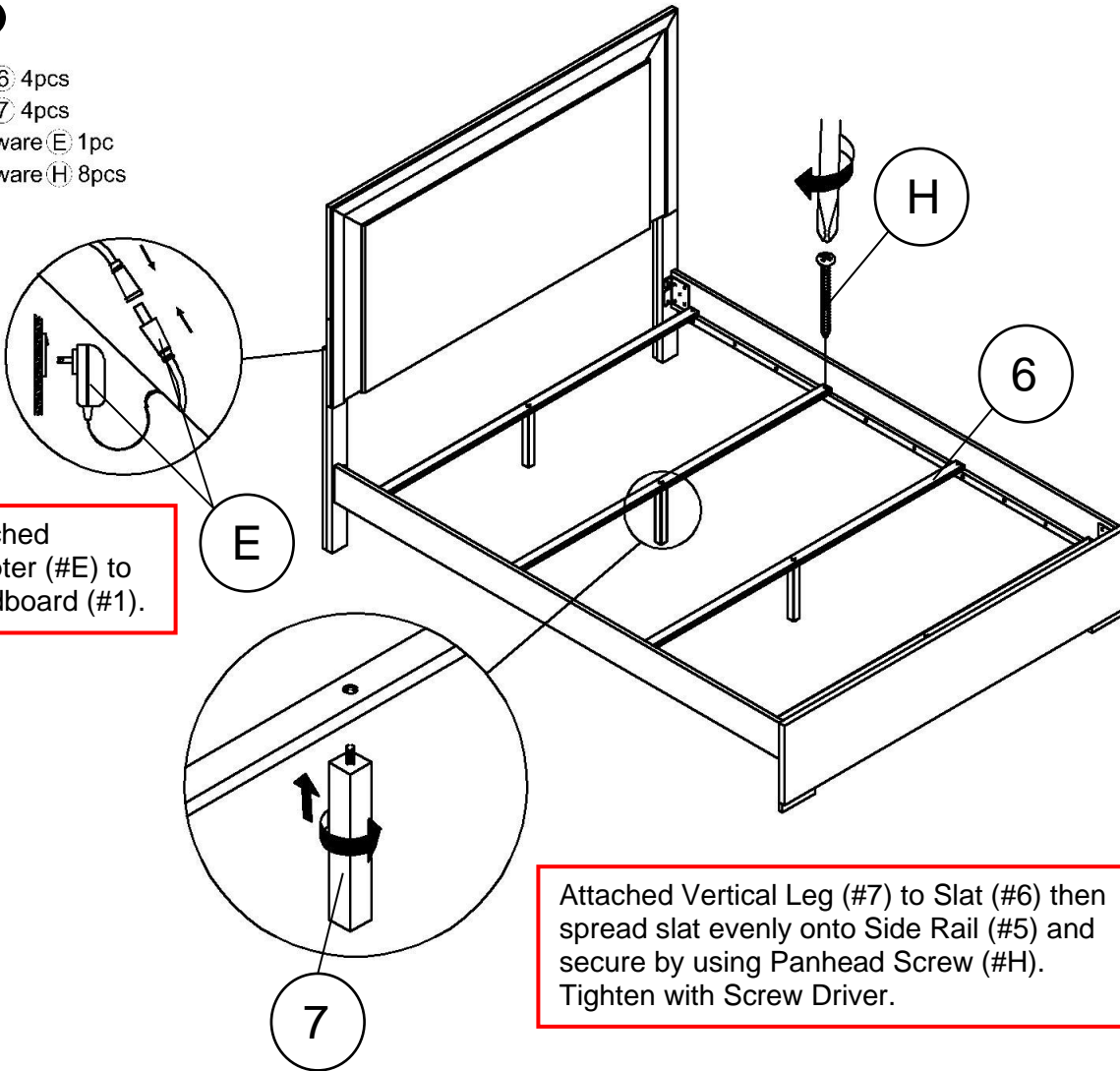

Attached Adapter (#E) to Headboard (#1).

Attached Vertical Leg (#7) to Slat (#6) then spread slat evenly onto Side Rail (#5) and secure by using Panhead Screw (#H). Tighten with Screw Driver.

## ASSEMBLY COMPLETED



Please ensure the furniture rests on an even and flat surface. If the product wobbles or feels loose, double-check all bolts and/or screws are properly tightened and secured.

### Keep this handy!

Please retain this instruction manual and any order-related information for future reference.

### Lift, don't drag!

To avoid damage to product please always LIFT the product when transporting or adjusting the placement.

This product is intended for RESIDENTIAL USE ONLY and not for commercial use.