

**TOOLS REQUIRED
OUTILS REQUIS**

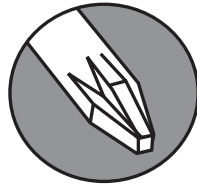

**TWO PEOPLE REQUIRED FOR ASSEMBLY
DEUX PERSONNES REQUISES POUR L'ASSEMBLÉE**



**Move this piece of furniture gently with 2 persons.
Déplacer ce meuble doucement avec 2 personnes.**



DO NOT ASSUME CHILD SAFETY WITH ANY PIECE OF FURNITURE!

Do not allow children to climb on dressers or in drawers. Do not stand or jump on beds. Improper use can cause death and or serious injury. If you are placing a TV on top of dressers use safety straps provided with your TV to prevent the risk of a toppling television. Furniture straps fastened to a wall can also be used to help ensure safety.

Damaged parts or furniture put together incorrectly can lead to serious injuries. Make sure to follow instructions correctly.



N'assumez pas la sécurité des enfants avec n'importe quel meuble ou pièce.

Ne permettez pas aux enfants de grimper sur les meubles ou les tiroirs. Ne pas se tenir debout ou sauter sur le lit.

L'utilisation inexacte peut causer des blessures sévères ou fatales. Si vous placez votre téléviseur au dessus du meuble assurez-vous d'utiliser les lanières de sécurité (inclus avec votre téléviseur) pour prévenir le risque de basculer le téléviseur. Les lanières de sécurité pour meuble fixées au mur peuvent aider à assurer la sécurité.

Des pièces endommagées ou un meuble assemblé incorrectement peut mener à des blessures. Assurez-vous de bien suivre les instructions.



Read this assembly manual carefully, and verify that you have all the parts listed before you begin. Keep your assembly manual for future reference.

Lisez ce manuel de montage soigneusement. Soyez sûr que vous avez toutes les pièces d'équipement avant de commencer. Gardez ce manuel de montage pour futur référence.



**DO NOT USE POWER TOOLS TO ASSEMBLE THIS PRODUCT!
N'UTILISEZ PAS D'OUTILS POUR ASSEMBLER CE PRODUIT!**



Do not place very hot/cold objects on top of any surface. Always use a coaster or mat. Never leave liquids on the surface: Clean immediately with a mild soap and a damp cloth. Never use scouring powder based cleanser.

Ne placez pas très chaud/froid d'objets sur une surface. Utilisez toujours un coaster ou de tapis. Ne jamais laisser liquides sur la surface Nettoyer immédiatement avec un savon doux et d'un chiffon humide.



Protect finishes by placing furniture pieces on a soft carpeted surface during assembly.

Protégez la finition en plaçant les pièces du meuble sur un tapis doux pendant l'assemblage.







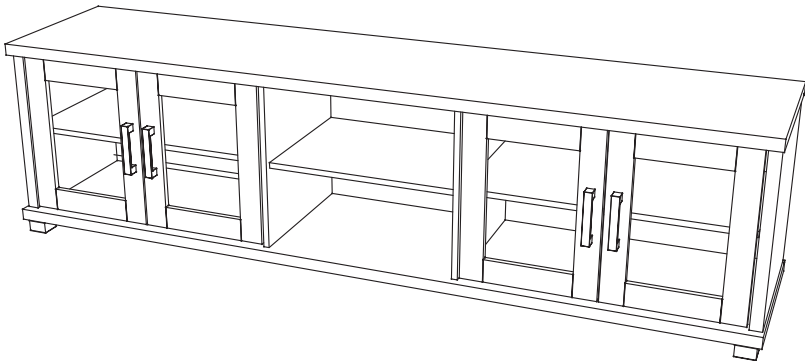
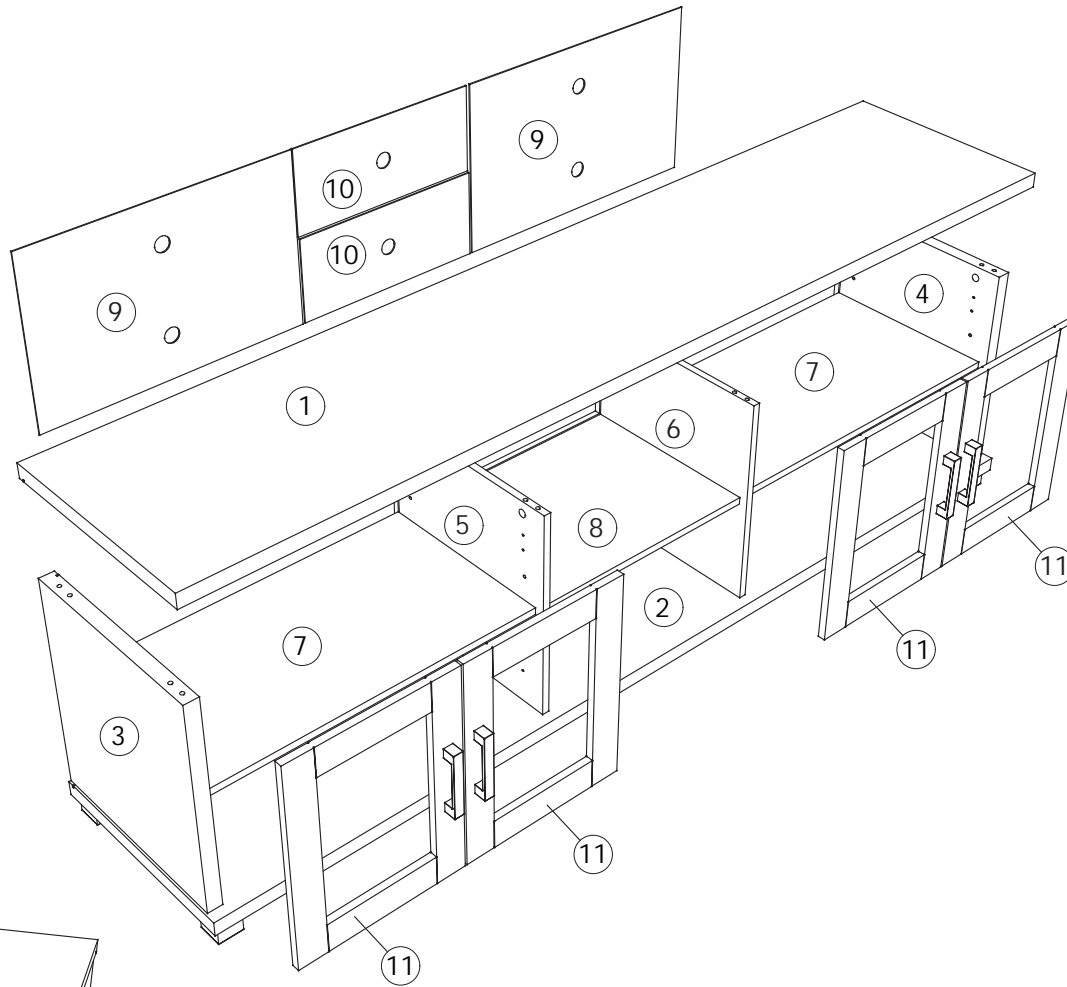











During assembly, please take care not to OVERTIGHTEN any fittings it may cause damage to the product.

Pendant l'assemblage, veuillez prendre soin de ne pas trop serrer les raccords il peut endommager le produit.

PART LISTS		
01	TOP	1
02	BOTTOM	1
03	SIDE L	1
04	SIDE R	1
05	CENTER L	1
06	CENTER R	1
07	SHELF (B)	2
08	CENTER	1
09	BACK (L & R)	2
10	BACK (M)	2
11	DOOR	4



HARDWARE LISTS

A MINIFIX (S)  H00130 8	B MINIFIX (S)  H00131 8	C DOWEL 8X35  H00002 20	D DOOR BUFFER  H00206 4	E CSK 4X13  H00035 24	F CSK 4X16  H00036 16	G CSK 3.5X12  H00032 16	H CSK 3X16  H00031 2		
I JCBW 6X50  H00047 10	J STEEL  H00135 8	K HANDLE 6085  H00242 4	L HS 18MM  H00236 8	M DOOR BUFFER  H00123 2	N PYRAMID ANGLE CORNER  H00168 8	O TAPPING SCREW M4X3.4  H00046 8	P PVC LEG  H00247 6	Q HINGE 7/8" (Normal)  H00243 8	X L-KEY (M4)  H00110 1

Part Listing

01

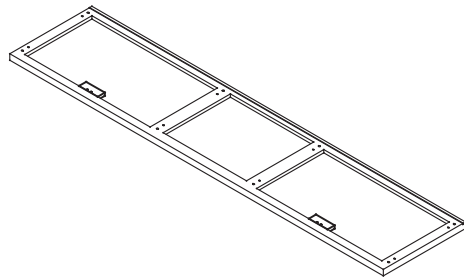
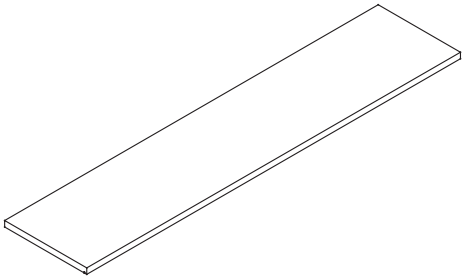

04

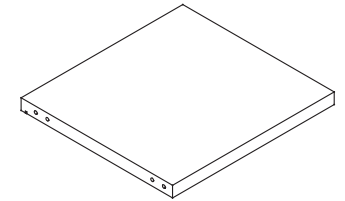
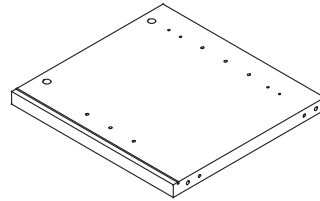

02

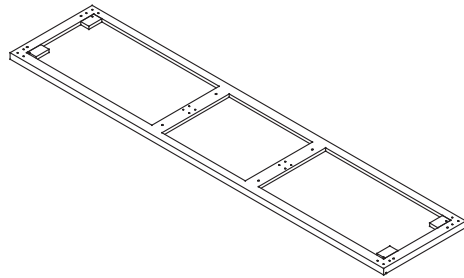
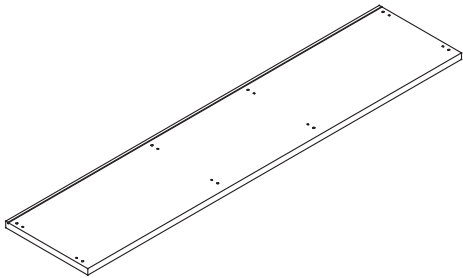

05

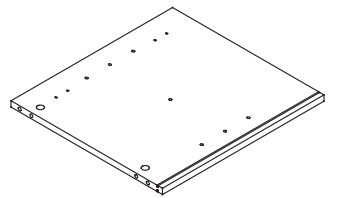
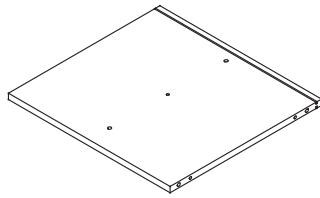

03

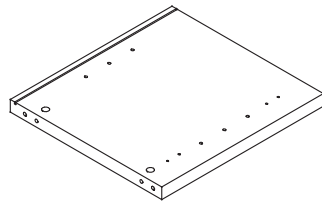
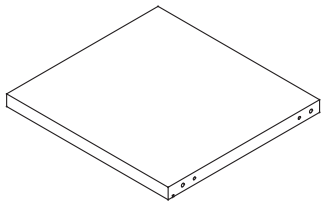

06

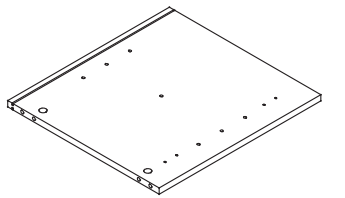
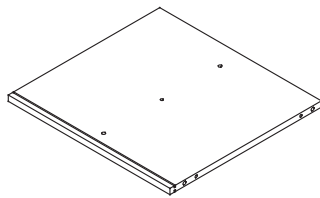

Part Listing

07

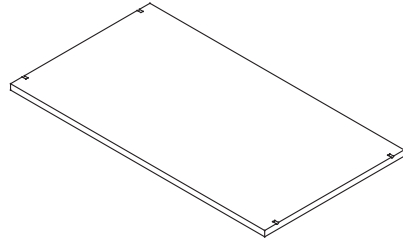
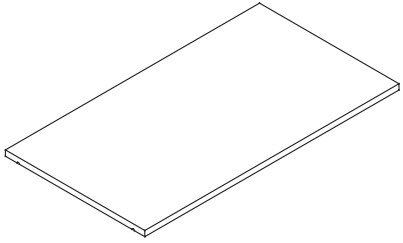

10

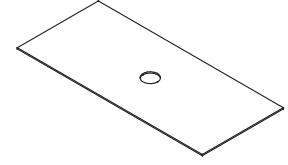
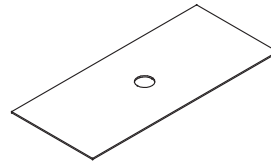

08

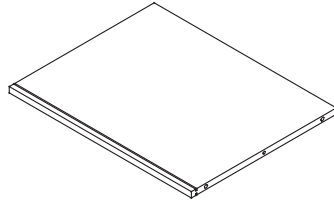
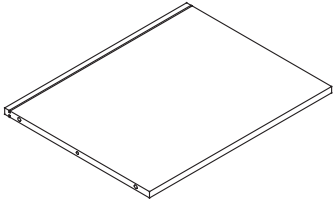

11

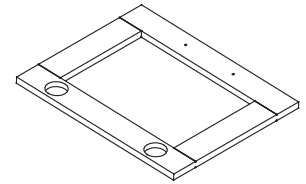
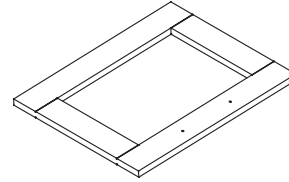

09

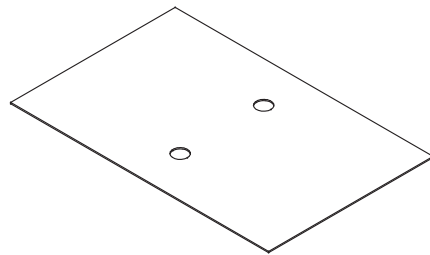
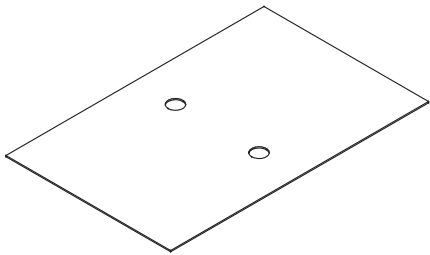

1

B x 8

Q x 8

M x 2

C x 20

F x 16

G x 16

H x 2

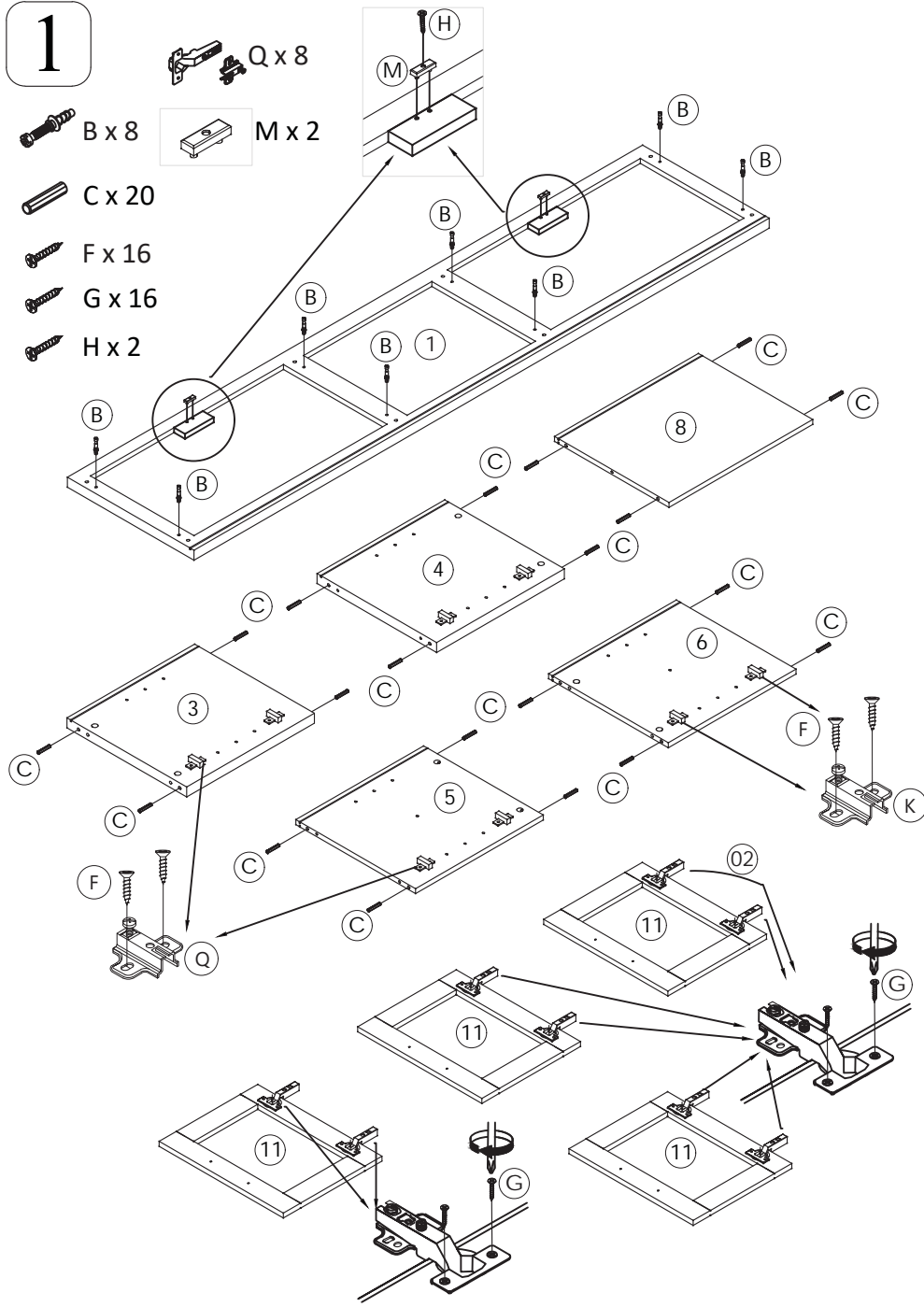

2

E x 24

P x 6

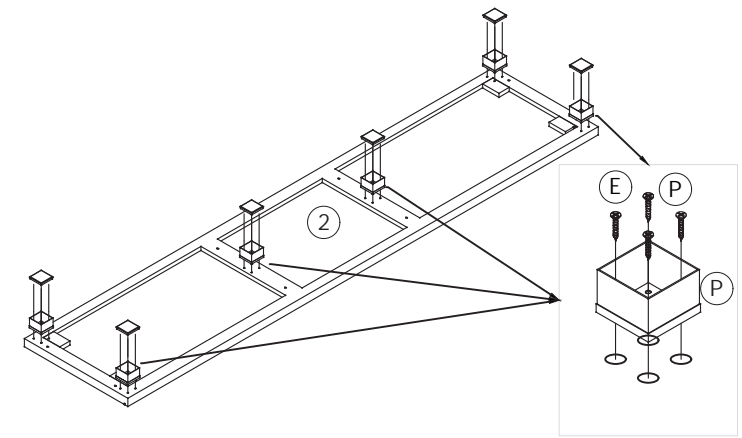

3

I x 2

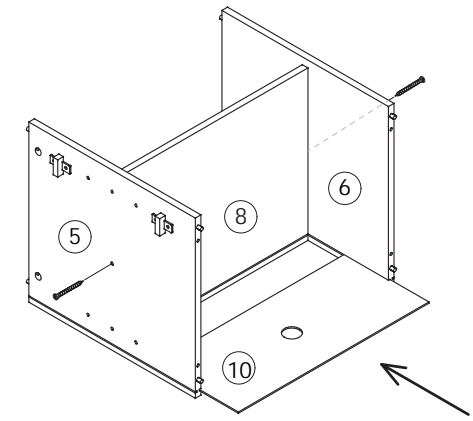

4

I x 8

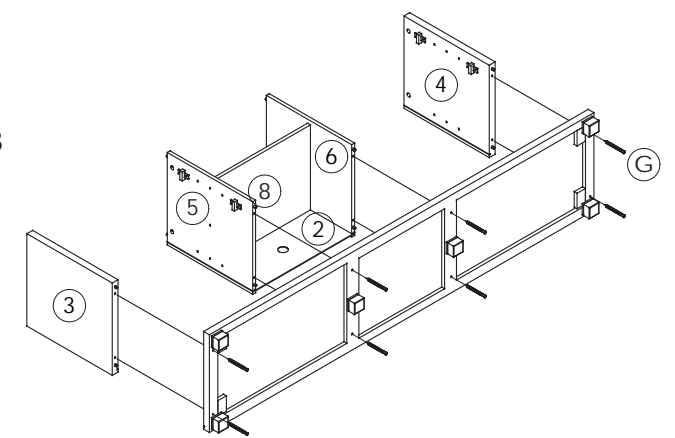

5

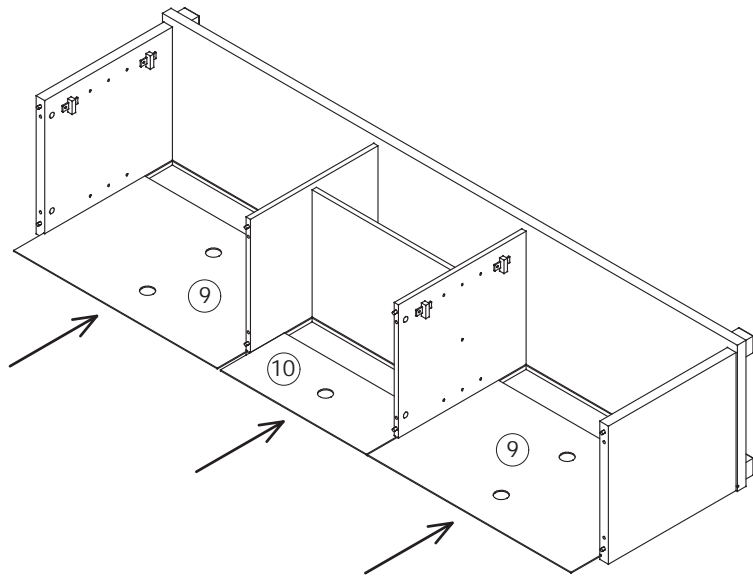

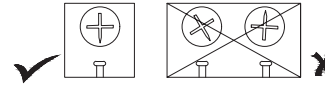

6

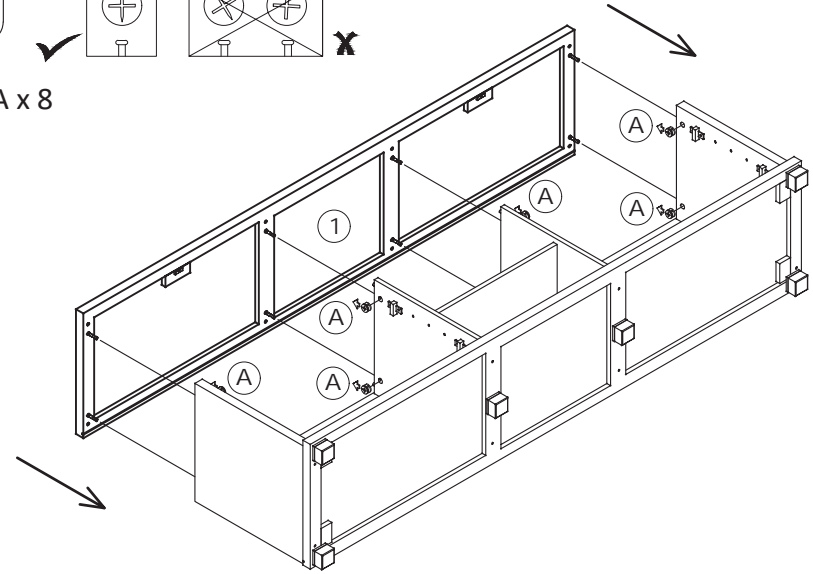

A x 8



7

-  D x 4
-  K x 4
-  L x 8

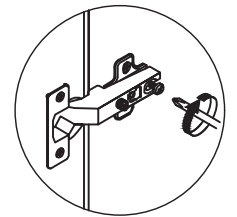
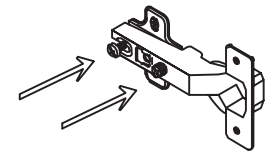
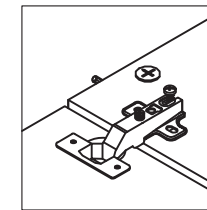
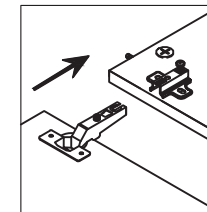
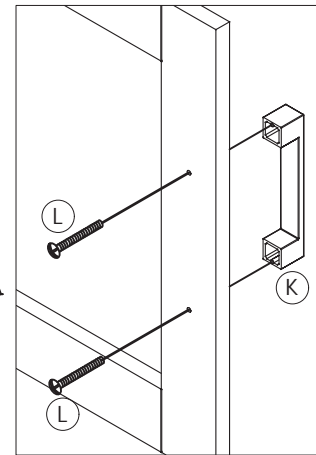
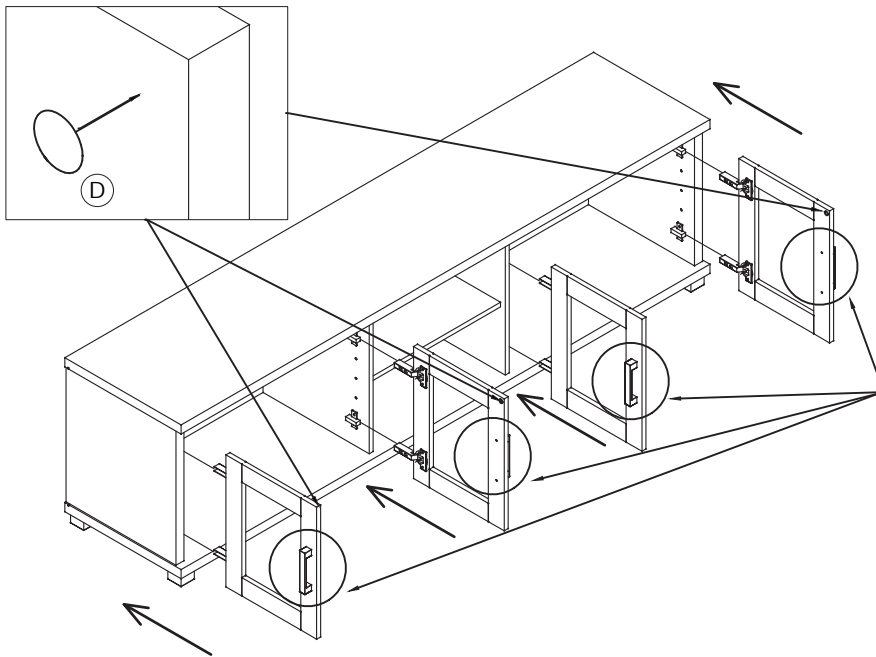

8

J x 8

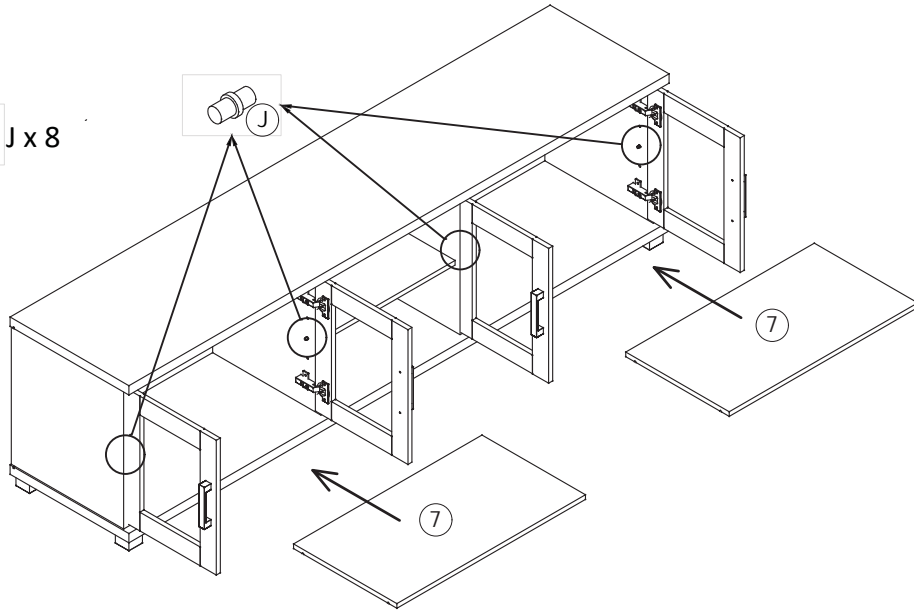

9

N x 8

O x 8

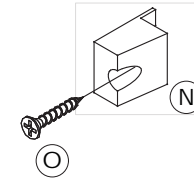

10

