

LUXMARS

Adjustable Facial Chair & Barber Chair Instruction Manual



Shampoo basin Instruction



Part A

				
A1.1PC	A2.1PC	A3.4PCS	A4.4PCS	A5.4PCS(small)

Step 1: Make part "A4" through plastic cover part "A3"

Step 2: Link part "A1" and part "A2" by assembled screws "A4" and "A5", Tighten. (please note direction of "A2", the hole of part "A2" should be aligned with the opening of the drain pipe at the bottom of the basin)



Part B

				
B1.1PC	B2.1PC	B3.1PC	B4.1PC	B5.1PC(big)





Step 3: Insert the part "B4" into the left hole of "A2" as shown in the picture below.

Step 4: Make part "B2" through part "B3"

Step 5: Link part "B1" and part "A2" by assembled adjust bar "B3" and the part "B5", Tighten.



Part C



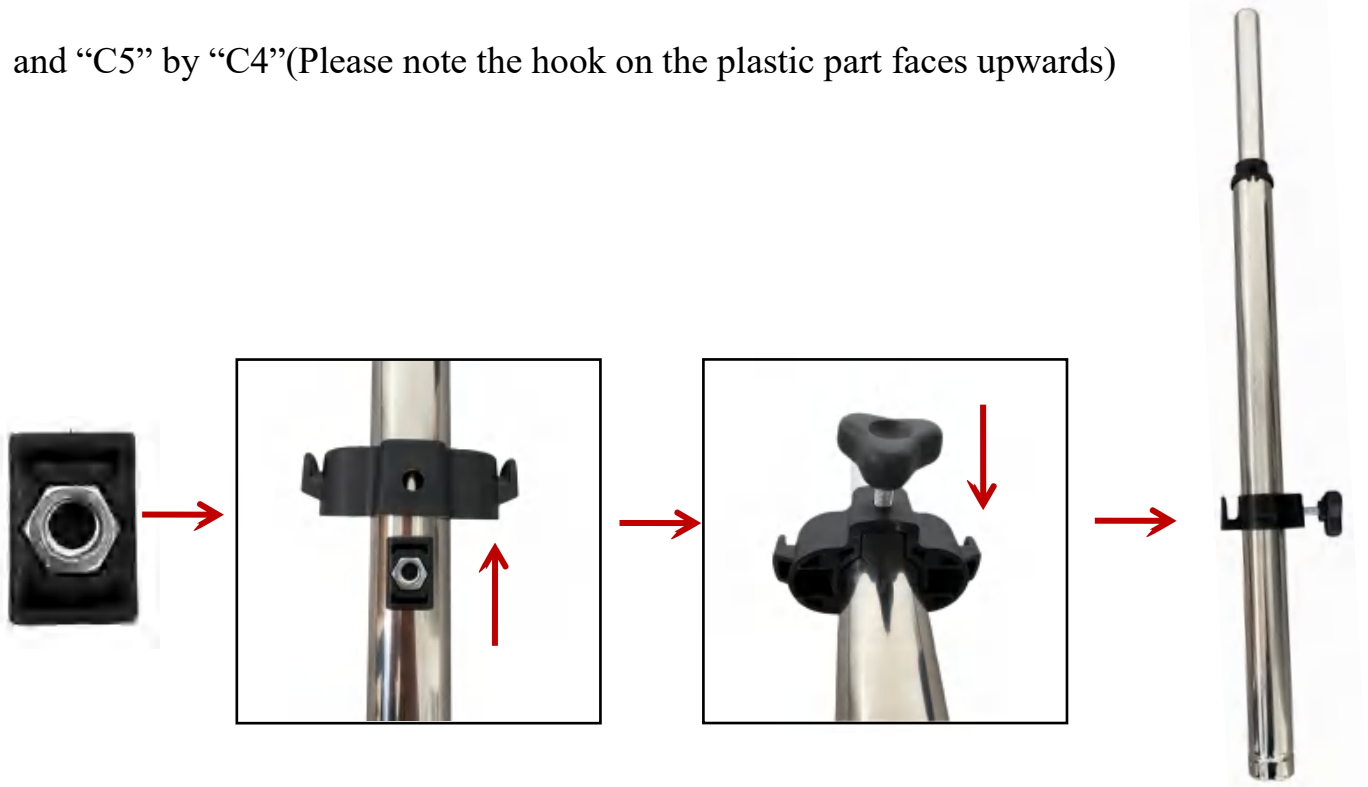

				
C1.1PC	C2.1PC	C3.1PC(medium)	C4.1PC	C5.1PC

Step 6: Snap the nut “C3” into the groove of “C2”, then snap it into the groove of “C5”.

Step 7: Thread the part “C5” through the part “C1”, Stop at the groove of “C5”, Tighten “C1” and “C5” by “C4”(Please note the hook on the plastic part faces upwards)



Part D

				
D1.1PC	D2.1PC	D3.1PC	D4.1PC	D5.4PCS

Step 8:Part”D5” inserted into the bottom of “D1”

Step 9:Place the assembled “C5” into “D1”,Tighten by “D2” “D3” and “D4” as the picture shows

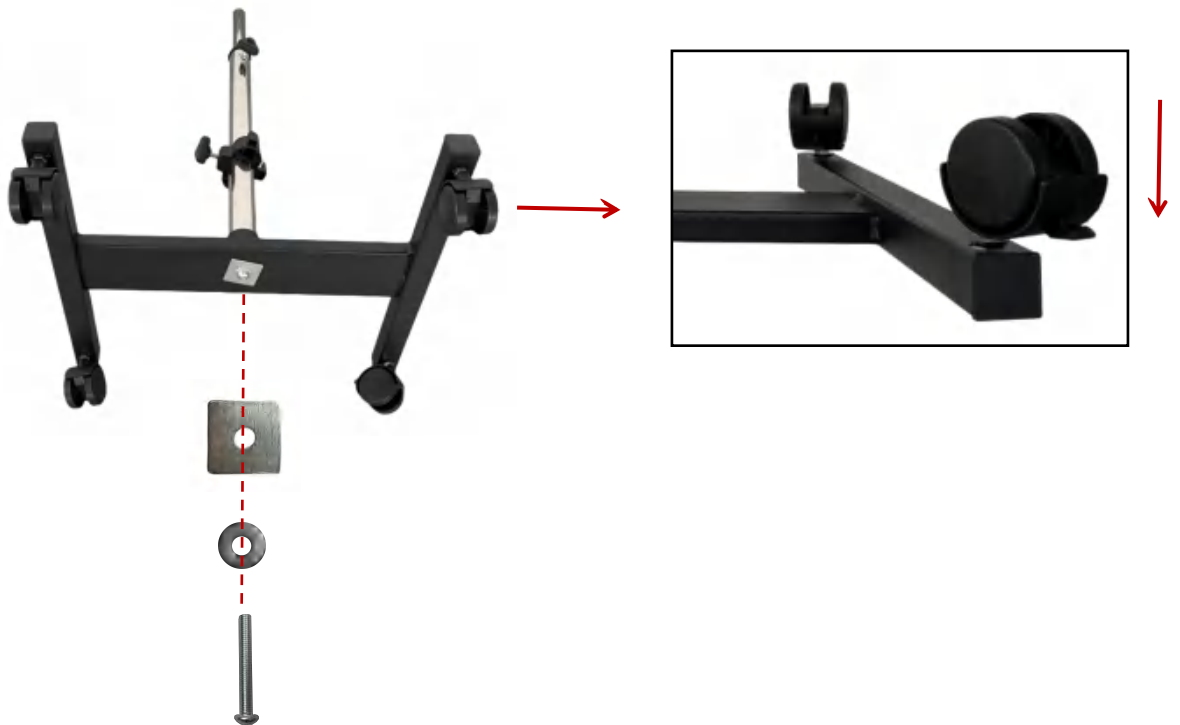

Part E

				
E1.1PC	E2.1PC	E3.1PC	E4.2PCS	E5.2PCS

Step 10:Attach the sewer pipe “E2” to the assembled “A1”, Tighten by E1 and E4(Note use the shorter one) as the picture shows



Step 11: Put the assembled plastic basin on the assembled iron base, Tighten by “E4”(Note use the longer one)

Step 12: Unscrew “E3” and push it through the hole in the wash basin, tightening.

Step 13: Insert the “E5” into the two holes of the plastic part “C1” respectively. As the picture shows.



Part F

				
F1.1PC	F2.1PC	F3.1PC	F4.1PC	F5.1PC
				
F6.2PCS	F7.2PCS	F8.2PC	F9.1PC	

Step14:Place the “F6” into the “E5” and adjust the appropriate position with part “C1”



Step15:Put the part “F8” on the part “F5” to protect the motor and connect the part “F5” to the “F3”,then connect “F4” to “F3” .As the picture shows.

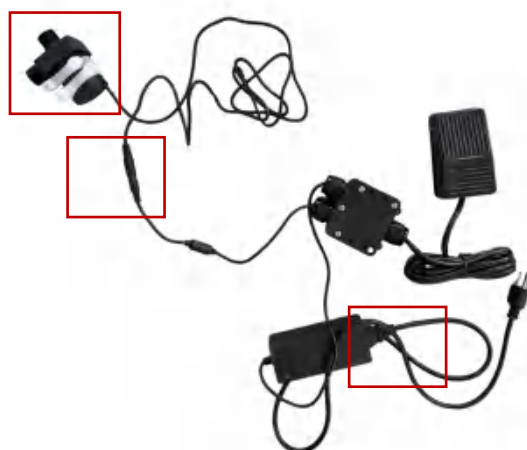

Step16:Connect the faucet “F1” to the water pipe “F2”, pass the water pipe through the lid of the shampoo basin and the bucket in turn, and then connect the water pipe and the water outlet of the pump,tighten.

Step 17:Place the pump in the bucket and connect the downpipe to another bucket.

Step 18:Place F9 in the middle of the shampoo basin.

