



Assembly Instructions

Caution : You must read this before you proceed

Care & Maintenance



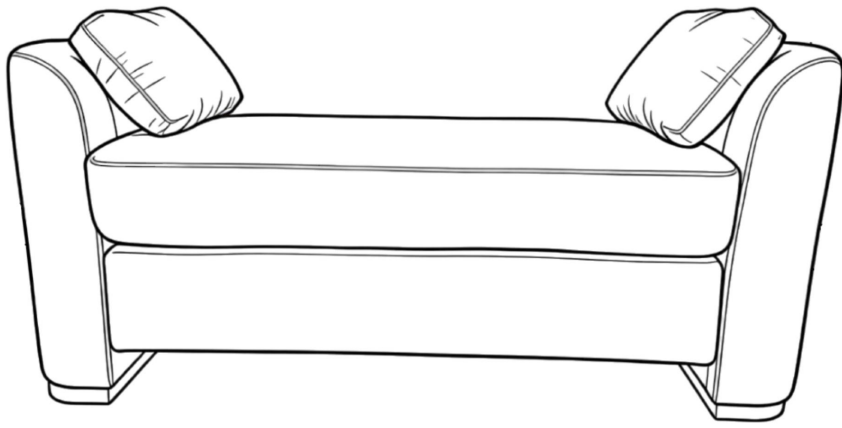

- ⊘  ● Not for commercial use. For residential use only.
- ✓  ● Furniture may scratch floors. We recommend using furniture pads to protect your floors.
- ⊘  ● Do not put hot items directly on furniture surface.
- ⊘  ● Do not clean furniture with harsh cleansers or polish.
- ⊘  ● Do not place furniture under direct sunlight.
- ⊘  ● Do not place furniture near heating or cooling vents.
- ⊘  ● Do not write on furniture without a padded barrier to protect the surface.
- ⊘  ● Do not place furniture outside . For indoor use only.
- ⊘  ● Stains may be removed with mild soap solution and damp cloth.
- ⊘  ● Children should not climb or jump on the furniture.
- ✓  ● Dust and pick-up spills using a clean, non-colored, lint-free cloth.

Please look in Ottoman for hardware packs and legs.



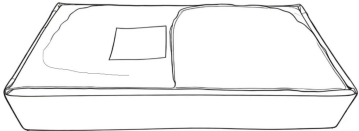
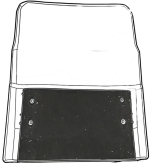
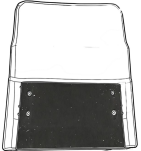

OTTOMAN



Parts List

Label	Picture	Description	QTY
A	 A line drawing of a rectangular frame with a central rectangular cutout, representing the base of the chair.	Bottom Frame	1
B	 A line drawing of a chair armrest, showing a curved top and a dark rectangular base.	Left Armrest	1
C	 A line drawing of a chair armrest, identical to the left armrest but mirrored.	Right Armrest	1
D	 A line drawing of a vertical wooden leg, showing a curved top and two circular feet at the bottom.	Left Wooden Leg	1
E	 A line drawing of a vertical wooden leg, identical to the left leg but mirrored.	Right Wooden Leg	1
F	 A line drawing of a rectangular cushion with a slightly raised edge.	Cushion	1
G	 A line drawing of a rectangular pillow with a slightly raised edge.	Pillow	2

Hardwares

Label	Picture	Description	QTY
①		Allen wrench	1
②		Bolt(M6*60mm)	17
③		Spring Gasket	17
④		Gasket	17

Assembly Preparation

Before Beginning Assembly:

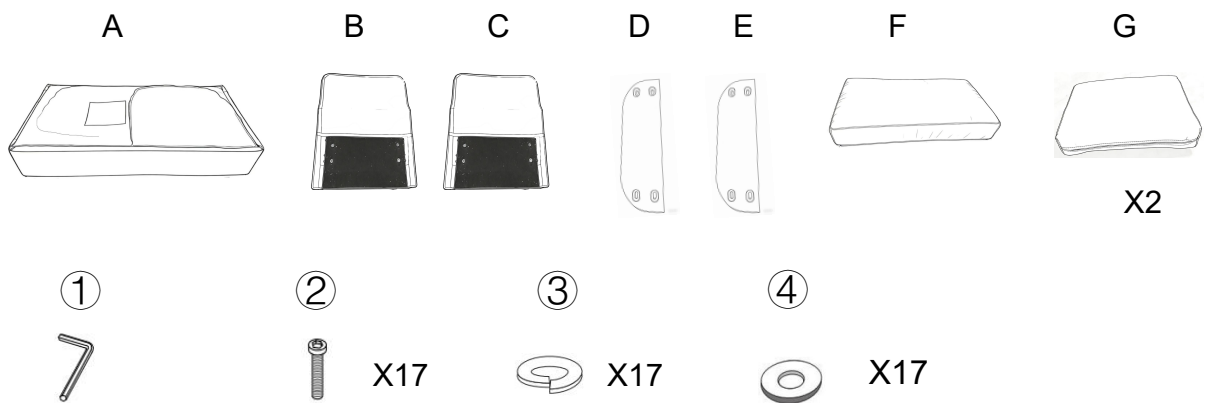

- Read instructions, cover to cover-



- Have 2 adults on hand for assembly-



- Do not assemble on flooring or carpet-



- Assemble on a clean non-marring surface (packing foam)-



- Save all packaging until finished-

Assembly Steps

Overview

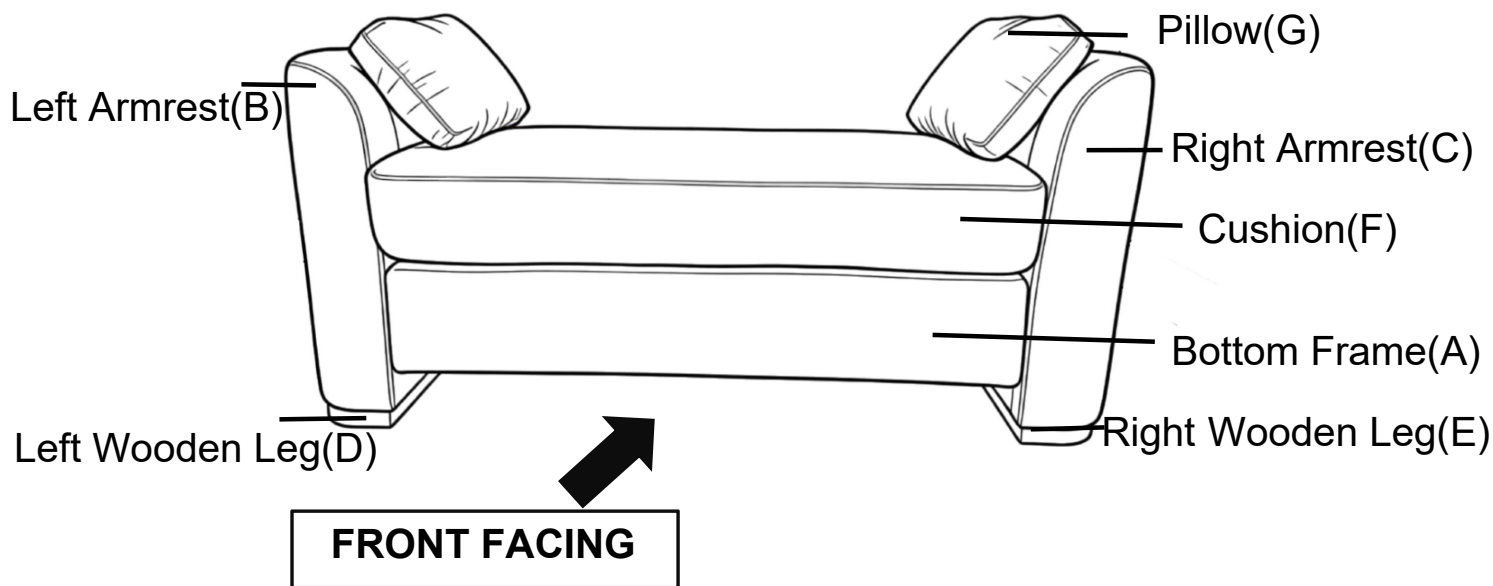

This ottoman has multiple parts and may require up to some 10 minutes to assemble. To give you an overview of the ottoman parts, the above picture is to help you put the various parts into perspective. Please read through the instructions below to familiarise yourself with the parts and steps before assembly.

Step 1

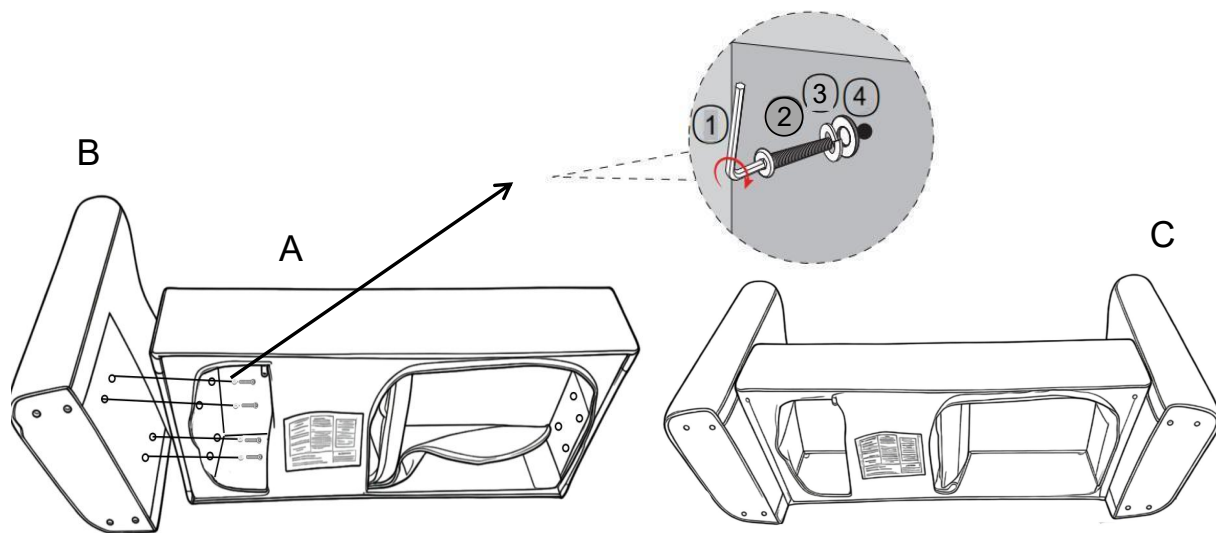

Place bottom frame(A) and left armrest(B) in a clean location, and use allen wrench(①), bolt(②), spring gasket(③), and gasket(④) to secure bottom frame(A) and left armrest(B) together as shown in the diagram. There are a total of four pairs of bolt. Repeat the above steps to secure right armrest(C) and bottom frame(A) together.

Step 2

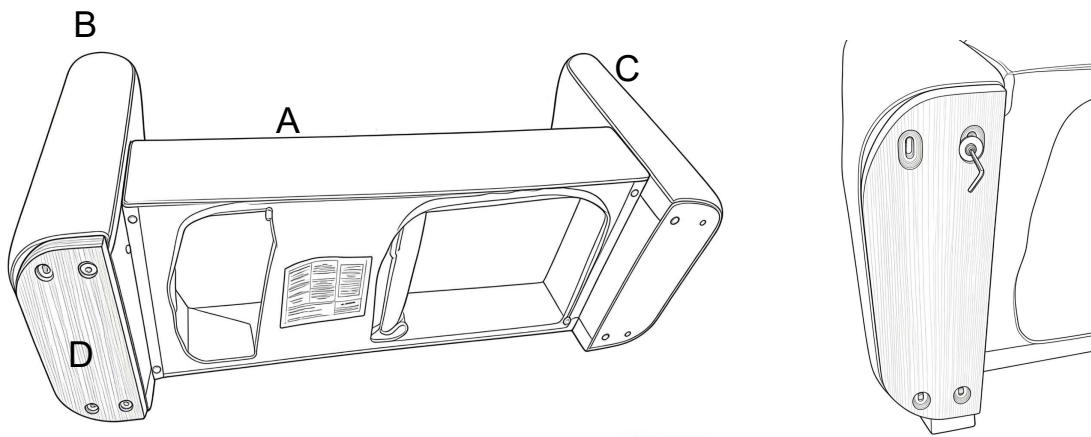

Place the assembled bottom frame(A)、 left armrest(B) and right armrest(C) side on a clean surface, take out left wooden leg(D) and right wooden leg(E) from the bottom, and use allen wrench(①), bolt(②), spring gasket(③), and gasket(④) to fix left wooden leg(D) and left armrest(B) together as shown in the diagram. There are a total of four bolt(②). Repeat the above steps to fix right wooden leg(E) and right armrest(C) together.

Step 3

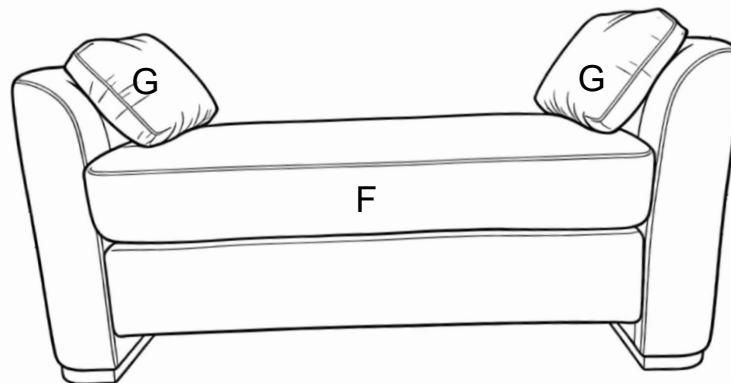

Unpack the cushion(F)(restore to their original state in 3minutes).Take out the pillow(G) from the bottom arrange as shown above.

Your ottoman is ready for use.

This ottoman can only be used on a flat, level surface.