













ASSEMBLY INSTRUCTION

DESCRIPTION : Queen Sleigh Headboard/ Footboard & Slats / Rails

Thank you for purchasing this quality product. Be sure to check all packing material carefully for small Hardware which may have come loose inside the carton during shipment. Identify and count all Hardware and compare with the Hardware List Below.

Part List		
①	Panel Headboard (Packed separately)	1 Pc
②	Left Leg Headboard (Packed inside HB)	1 Pc
③	Right Leg Headboard (Packed inside HB)	1 Pc
④	Bottom Rail (Packed inside HB)	1 Pc
⑤	Sleigh Footboard (Packed separately)	1 Pc
⑥	Bunfoot Footboard (Packed inside FB)	2 Pcs
⑦	Bed Rail (Packed separately)	2 Pcs
⑧	Slats (Packed inside Rail)	3 Pcs
⑨	Slat support (Packed inside Rail)	3 Pcs

Hardware List			
A	JCBC Screw Ø6 x 40mm		8 Pcs
B	Spring Washer Ø1/4"		8 Pcs
C	Flat Washer Ø1/4" x 19mm x 1mm		8 Pcs
D	Allen Key		1 Pc
E	Wood Dowel Ø8 x 30mm		4 Pcs
F	Hanger bolt Ø5/16" x 3"		2 Pcs
G	Hex nut-Curve washer		2 Pcs
H	Wrench Ø5/16"		2 Pcs
I	Wood Dowel Ø10 x 40mm		2 Pcs
J	Hanger bolt Ø5/16" x 3 1/2"		8 Pcs
K	Hexagon nut Ø5/16"		8 Pcs
O	Spring Washer Ø5/16"		8 Pcs
M	Screw M4 x 32mm		6 Pcs

STEP 1

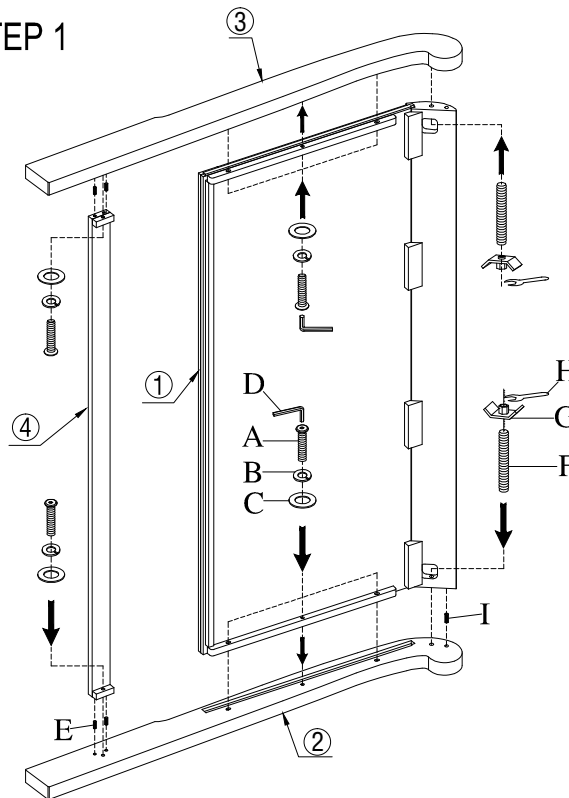

ASSEMBLY INSTRUCTION

DESCRIPTION : Queen Sleigh Headboard/
Footboard & Slats / Rails

