

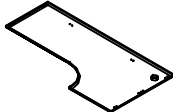

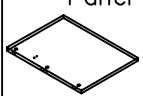

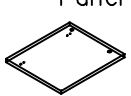

(1) Top  1PC	(2) End Panel  1PC	(3) End Panel  1PC	(4) Modesty Panel  1PC	(A) Dowel  12PCS+1	(B) Cam Pin  11PCS+1	(C) Cam Lock  11PCS+1	(p) Adhesive Cam Cover  11PCS+1	(D) Leg leveller  4PCS	(W) Grommet  1PC	STEP 3
--	---	---	---	---	--	--	--	---	---	--------

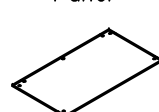

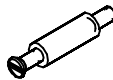
LEFT CORNER CREDENZA

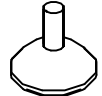
72" W*24/36" D*29" H

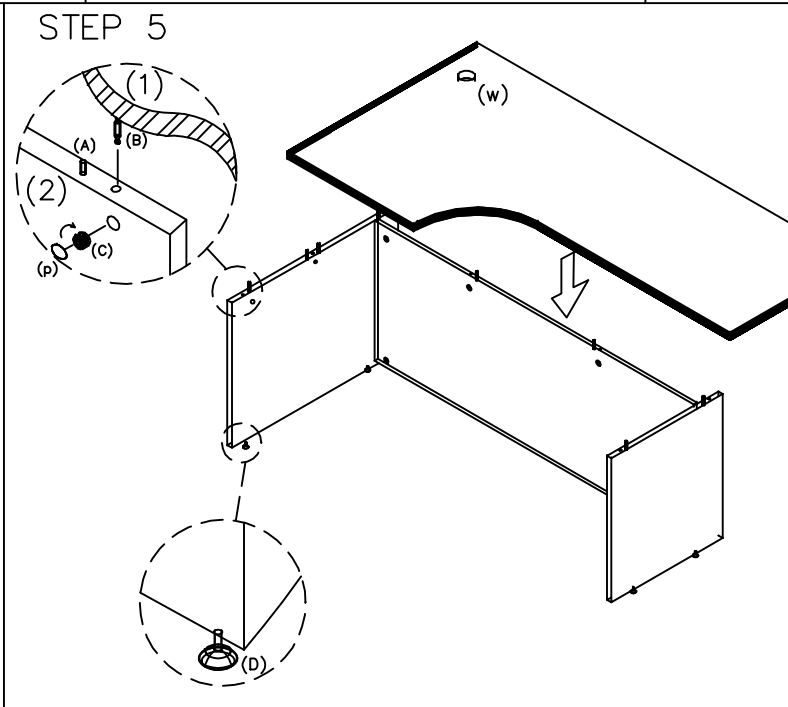
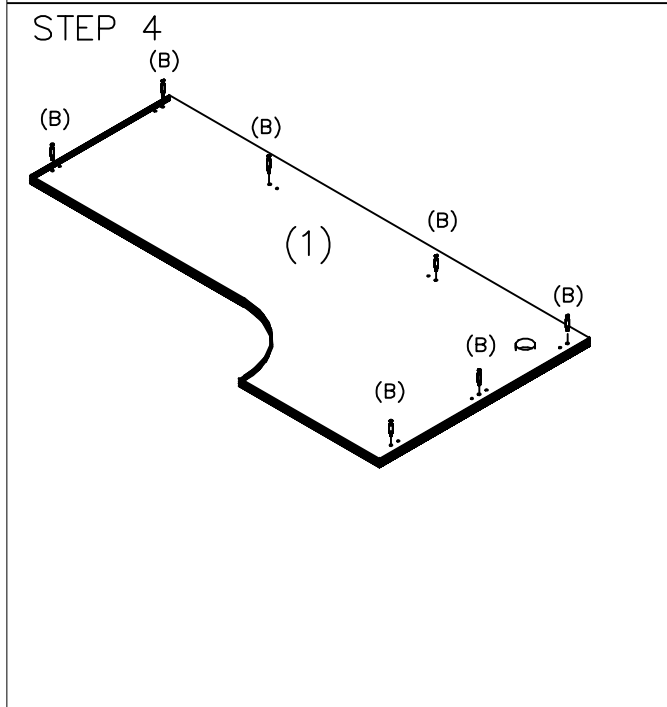
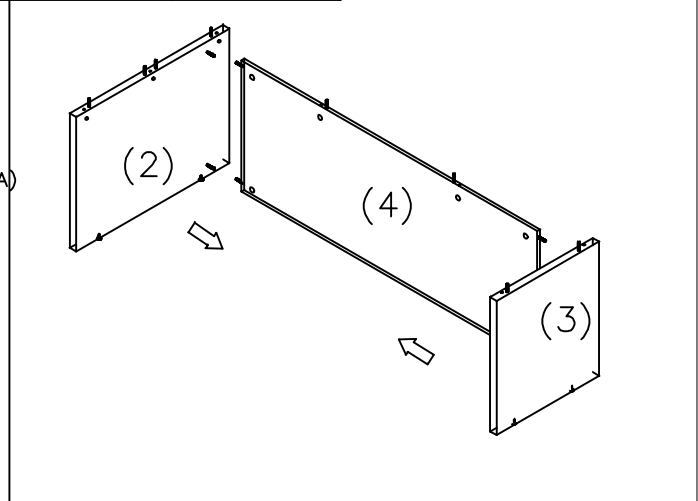
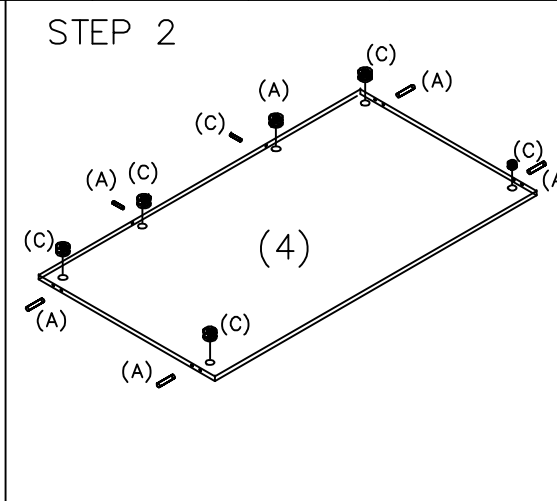
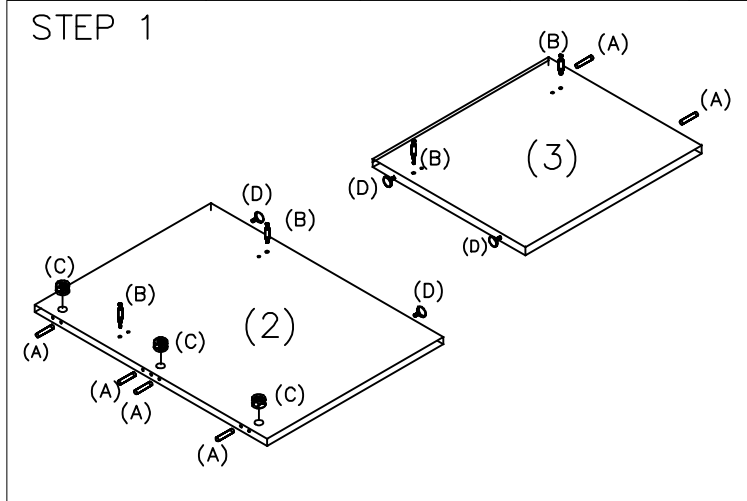
Always lay components on A clean, soft-cushioned surface during assembly.