

# Assembly Instructions

**Caution : You must read this before you proceed**

## Chaise Lounge

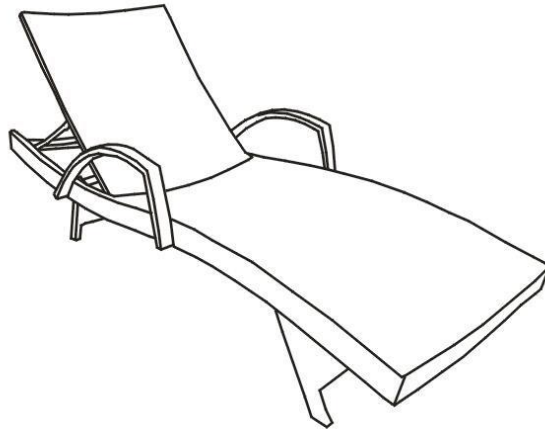

### Parts List

Label	Picture	Description	QTY
A	A line drawing of the main base of the chaise longue, showing the frame and the reclining mechanism.	Chaise Longue Base	1
B	A line drawing of the left armrest, which is a curved metal piece.	Left Arm	1
C	A line drawing of the right armrest, which is a curved metal piece.	Right Arm	1

### Hardware

Label	Picture	Description	QTY
①	A line drawing of an L-shaped Allen key.	Allen Key	1
②	A line drawing of a bolt with a hexagonal head and a threaded shaft.	Bolt (M8*40MM)	5
③	A line drawing of a circular washer with a central hole.	Washer (M8*40MM)	5

# Assembly Preparation

Before Beginning Assembly:

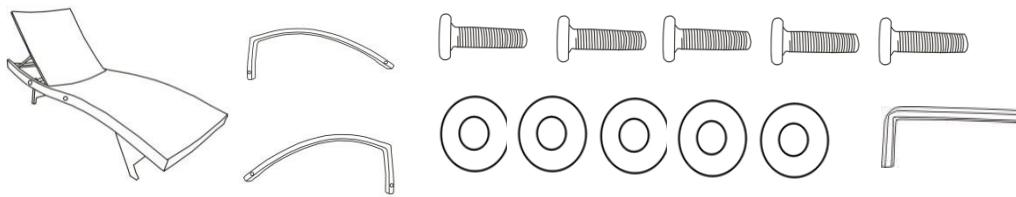

- Read instructions, cover to cover-



- Have 2 adults on hand for assembly-



- Do not assemble on flooring or carpet-



- Assemble on a clean non-marring surface (packing foam)-



- Save all packaging until finished-

# Assembly Steps

## Overview

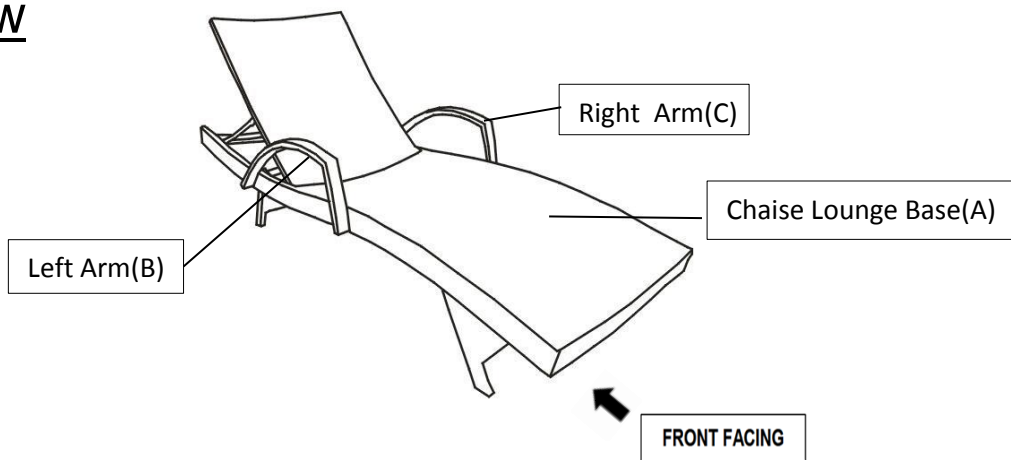

This Chaise Lounge has multiple parts and may require up to 30 minutes to assemble. To give you an overview of the Chaise Lounge parts, the above picture is to help you put the various parts into perspective. Please read through the instructions below to familiarise yourself with the parts and steps before assembly.

## Step 1

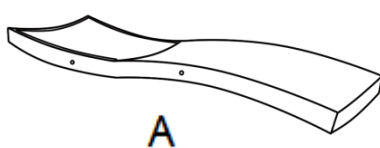

A



B



C

Open the carton, place all the parts onto a clean, non-marring surface, with the assistance of your adult partner.

## Step 2

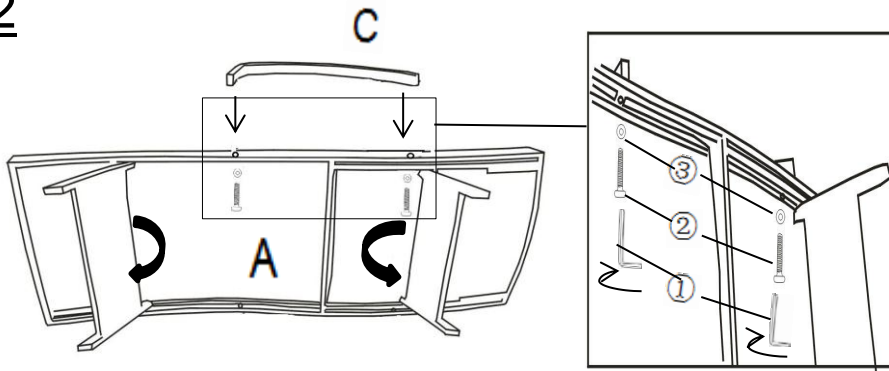

With the help of your adult partner, fold out the legs of Chaise Lounge Base(A) on a soft and clean surface.

Place Right Arm(C) onto the Chaise Lounge Base(A) as pictured.

Attach Right Arm(C) to Chaise Lounge Base(A) using Bolts(②) and Washers(③) with Allen Key(①).

**Because the bolts are not easy fully tighten at this stage, so fully tighten the bolts in step 3.**

## Step 3

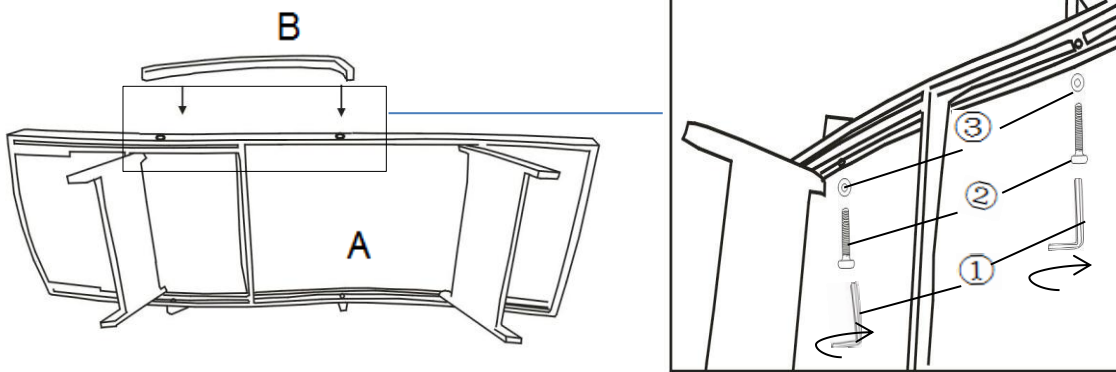

With the help of your adult partner, carefully turn the Chaise Lounge Base(A) over.

**Tighten the bolts of Step 2.**

Place the Left Arm(B) onto the Chaise Lounge Base(A) as pictured.

Attach Left Arm(B) to Chaise Lounge Base(A) using Bolts(②) and Washers(③) with Allen Key(①).

**Because the bolts are not easy fully tighten at this stage, you should carefully turn the chaise lounge over on the clean and soft surface with the help of your adult partner, fully tighten all bolts.**

## Step 4

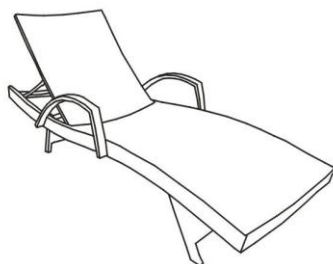





















With the help of your adult partner, stand the Chase Lounge right side up.

Your Chaise Lounge is ready for use.

**This Chaise Lounge can only be used on a flat, level surface.**

## Care & Maintenance

-   ● Do not put hot items directly on furniture surface
  -   ● Do not clean furniture with harsh cleansers or polish.
  -   ● To obtain the longest lifespan of your outdoor products, minimizing exposure to direct sunlight is recommended.
  -   ● Children should not climb or jump on the furniture.
  -   ● Do not write on furniture without a padded barrier to protect the surface.
  -   ● To obtain the longest lifespan of your outdoor products, avoid extended and lengthy exposure to rain, snow, and direct sunshine. Whenever possible cover the product and /or place under patio or awnings.
  -   ● Not for commercial use. For residential use only .
  -   ● Stains may be removed with mild soap solution and damp cloth.
  -   ● Keep away from sources of ignition.
- 
-   ● Dust and pick-up spills using a clean, non-colored, lint-free cloth .

### What is Proposition 65?

Proposition 65 is a California law that requires warning labels on products that may contain one of more than 800-plus chemicals or ingredients that the California Office of Environmental Health Hazard Assessment (OEHHA) has deemed to cause cancer or other reproductive toxicity.

Chemicals and elements on this list include wood dust, brass, and other everyday substances, which can be found in very common household items, such as: lamps, tableware, jewelry, crystal glasses, electric cords, beauty products, automobiles, and furniture.

### Why Did I Find a Proposition 65 Warning on My Home Goods Product?

We include Proposition 65 warnings on all of our products because there is always a chance that one of the 800-plus common chemicals and ingredients listed under this law could potentially be on our furniture or packing materials. We risk large fines under this law, if we don't include this warning.

### Should I worry?

We realize you may be worried finding this warning on our products, but we want to reassure you that the hazardous exposure limits for any of these chemicals have never been found on furniture products that we've shipped to our customers. Additionally, this warning label is very common and can be found on almost every piece of furniture sold in the state of California.

### Just How Common Are Proposition 65 Warnings?

Proposition 65 warnings have become so common in California that it is hard to take a trip to a local bank, grocery store, or restaurant without finding at least one warning. In fact, even the Disney Land Resort has a Proposition 65 warning:

