

2 person

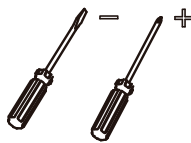

tools require



2 hours need



**PLEASE BE CAREFUL DO NOT DAMAGE THE HOLE POSITION
WHEN YOU USE POWER TOOLS !**

Before You Start

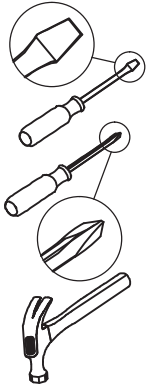

- ✓ Read through each step carefully and follow the proper order
- ✓ Separate and count all your parts and hardware
- ✓ Give yourself enough room for the assembly process
- ✓ Have the following tools: Flat Head Screwdriver, #2 Phillips Head Screwdriver and Hammer
- ✓ Caution: If using a power drill or power screwdriver for screwing, please be aware of to slow down and stop when screw is tight. Failure to do so may result in stripping the screw. (Assembly speed can be increased by using electric screwdriver)

Helpful Hints

PEOPLE NEEDED FOR ASSEMBLY: 1-2

- Open your item in the area you plan to keep it to avoid excessive heavy lifting.



- Identify, sort and count the parts before attempting assembly.

- Compression dowels are lightly tapped in with a hammer.



- Slides are labeled with an **R** (right) and **L** (left) for proper placement.



- Make sure to always face the point on the top of the Cam Lock towards the outer edge.



- If there is a back panel in the package, please install it to make sure your unit is complete and sturdy.



- Please fix all the screws provided for the back panel which can enhance product stability. If it is difficult to fix it when tightening, it can be fixed with the help of a hammer and then tightened.

- Do NOT use harsh chemicals or abrasive cleaners on this item.



- Never push, pull, or drag your furniture.



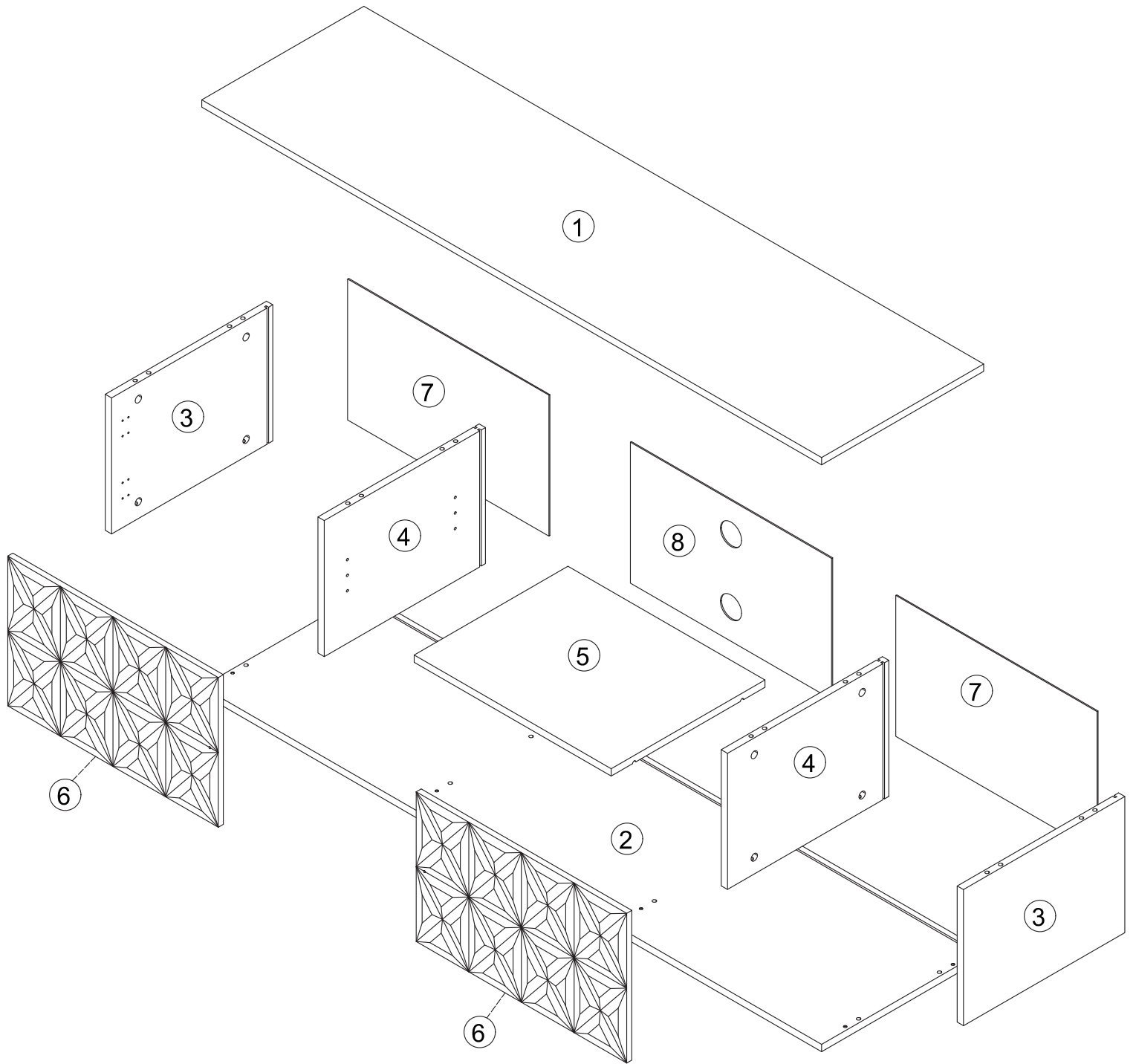

EXPLODED DRAWING:

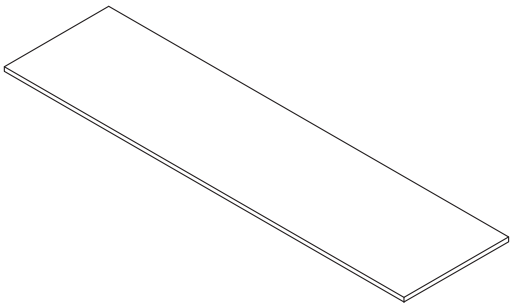
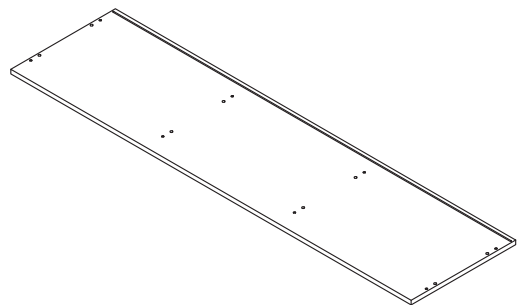
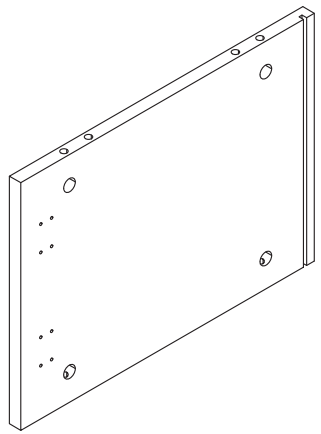
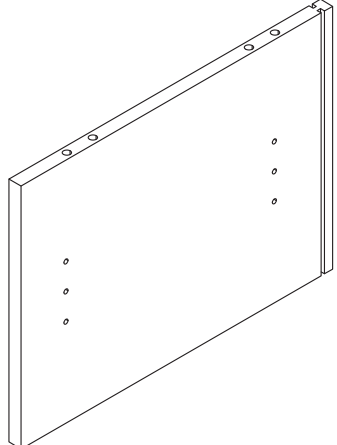
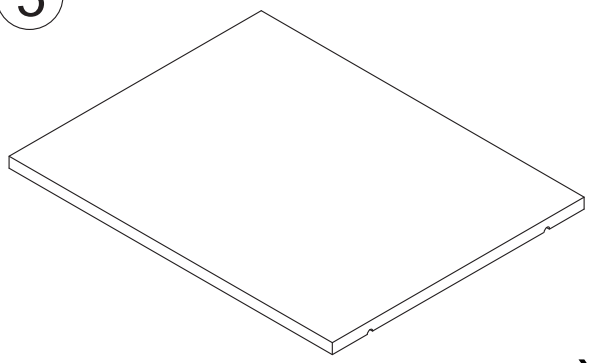
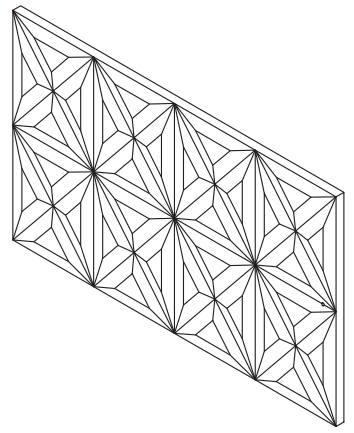
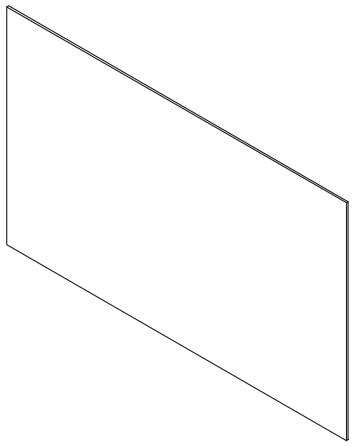
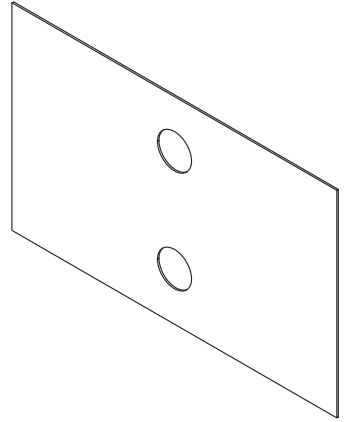

PART LIST:

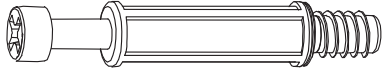
<p>①</p>  <p>X1</p>	<p>②</p>  <p>X1</p>
<p>③</p>  <p>X2</p>	<p>④</p>  <p>X2</p>
<p>⑤</p>  <p>X1</p>	<p>⑥</p>  <p>X2</p>
<p>⑦</p>  <p>X2</p>	<p>⑧</p>  <p>X1</p>

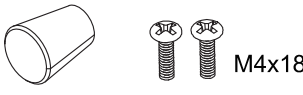
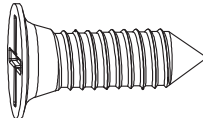
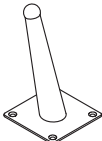
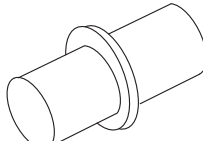
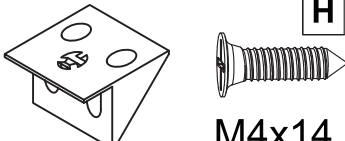
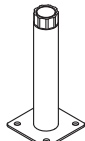
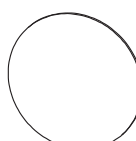
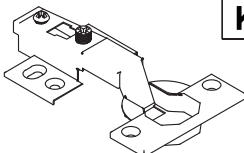
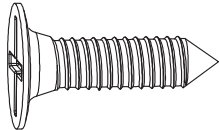
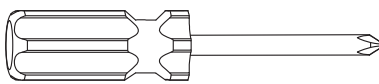
ACCESSORY LIST:

 A X16 ₊₄ Ø6×44mm	 B X16 ₊₄ Ø8×40mm	 C X16 ₊₄ Ø15mm
 D1 D2 +1 M4×18	 E X24 ₊₄ M4×11	 F X4
 G X4 ₊₁	 H X12 ₊₂ M4×14	 I X1
 J X16 ₊₄	 K X4	 L X20 ₊₄ M4×14
 M X1	 N1 N2 N3 N4 X2	

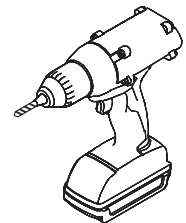

REMARK:

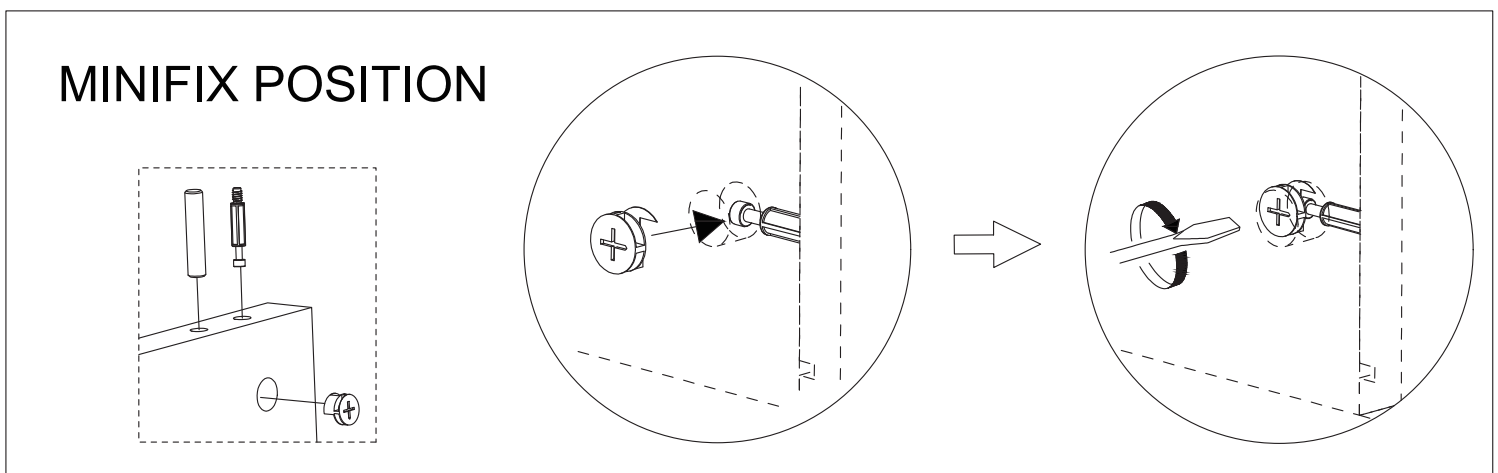

1.

REMARK:

Please do not screw **A** too deep or too shallow.

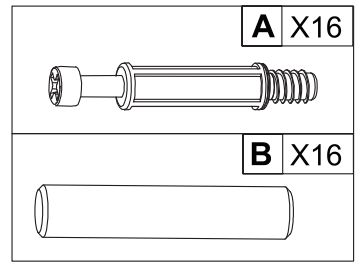
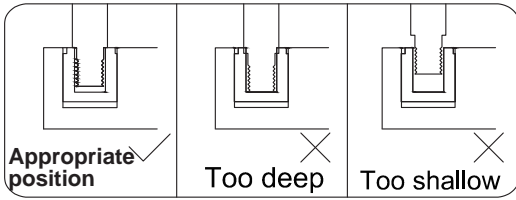

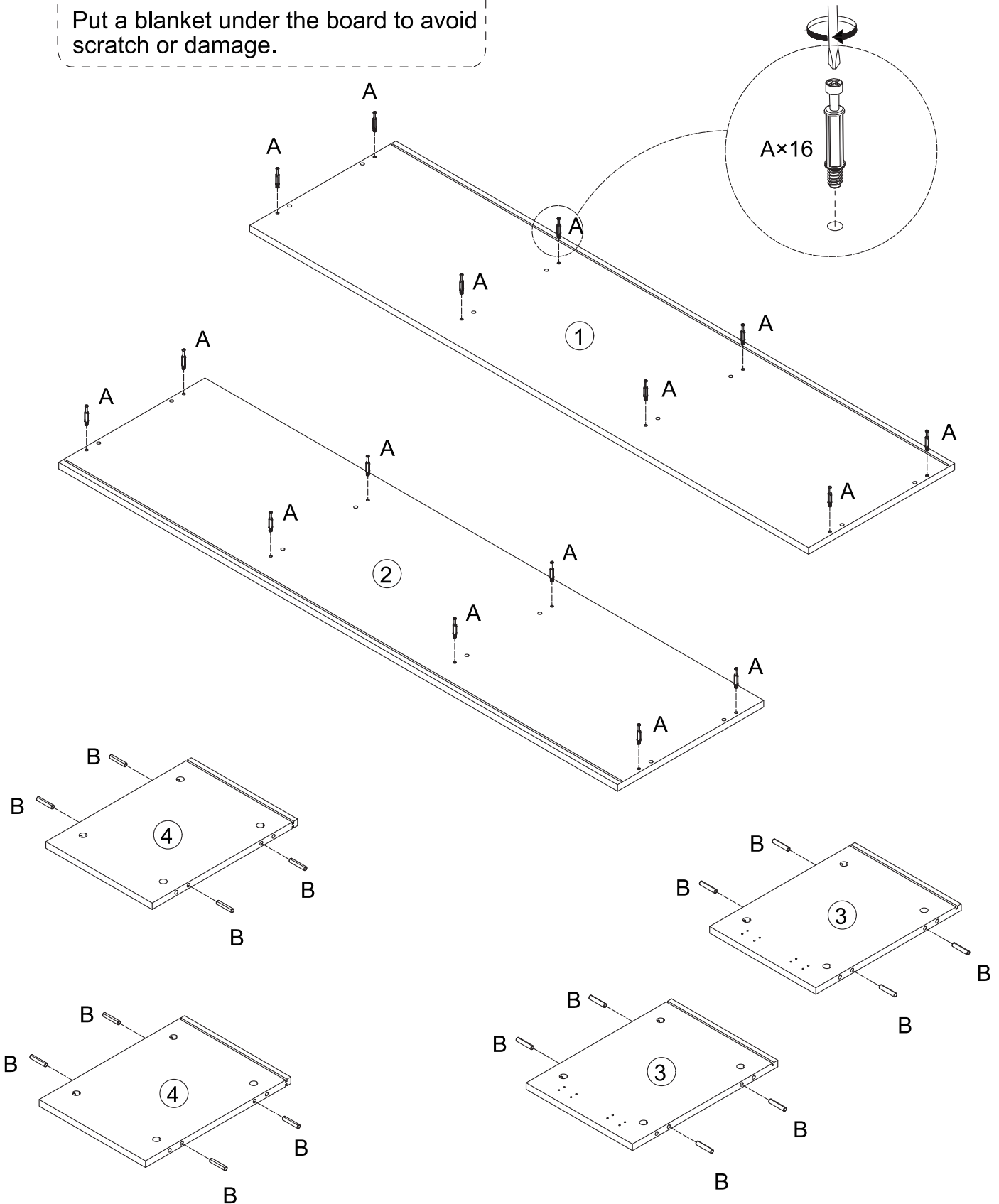

REMARK :

Put a blanket under the board to avoid scratch or damage.

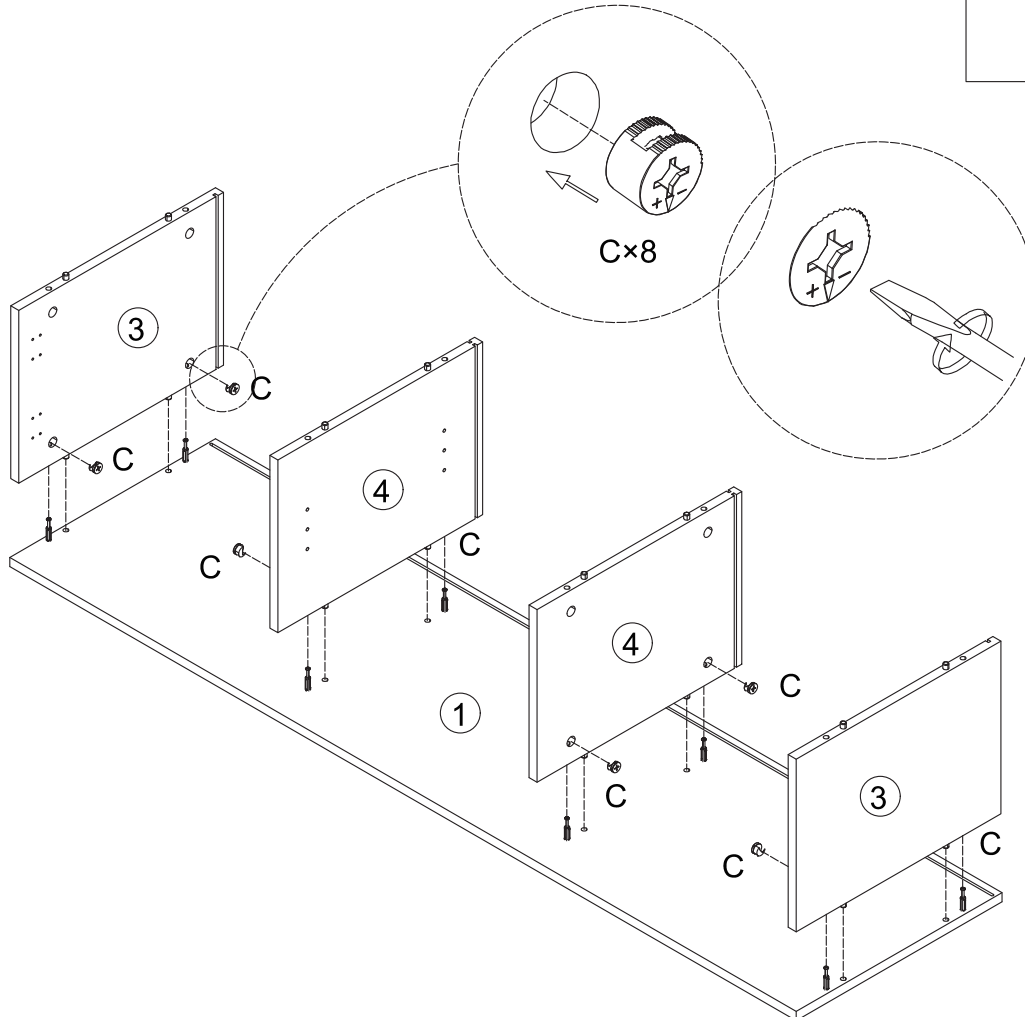

2.



	C X8
---	-------------

3.

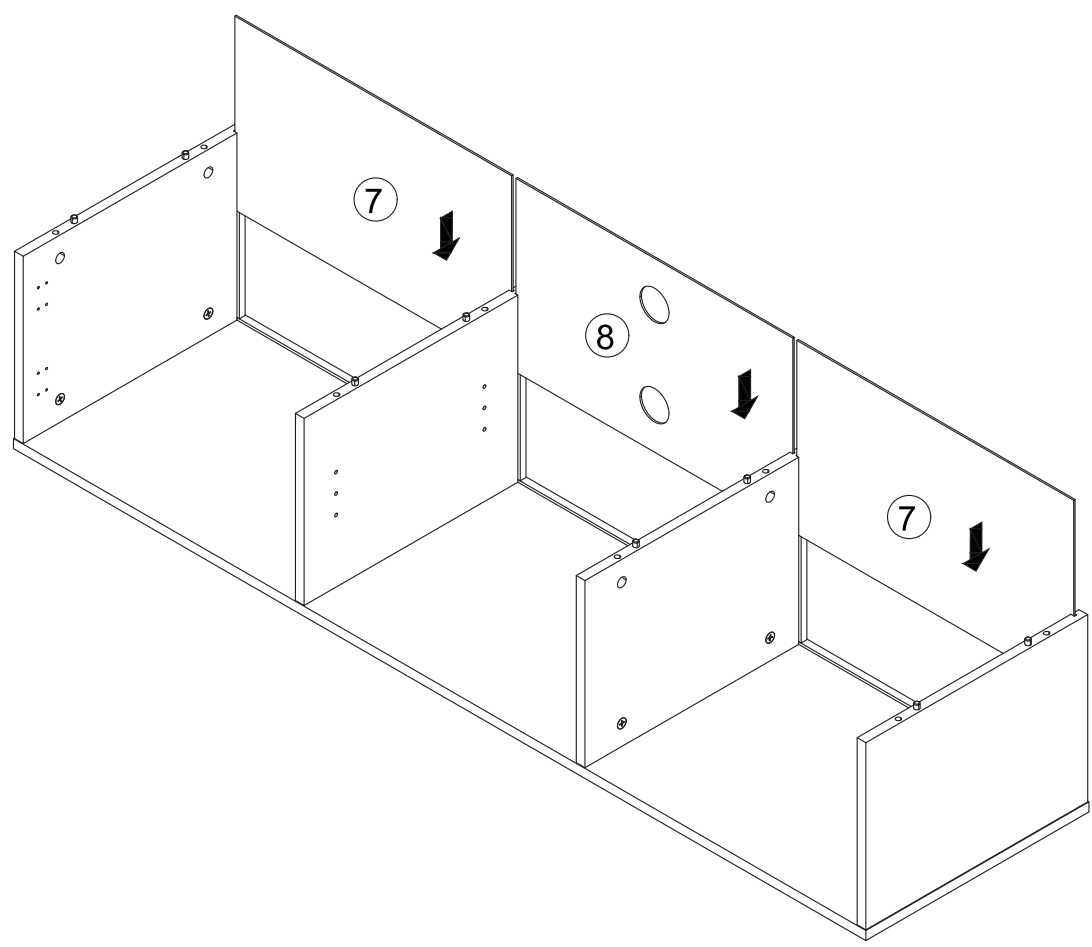

4.

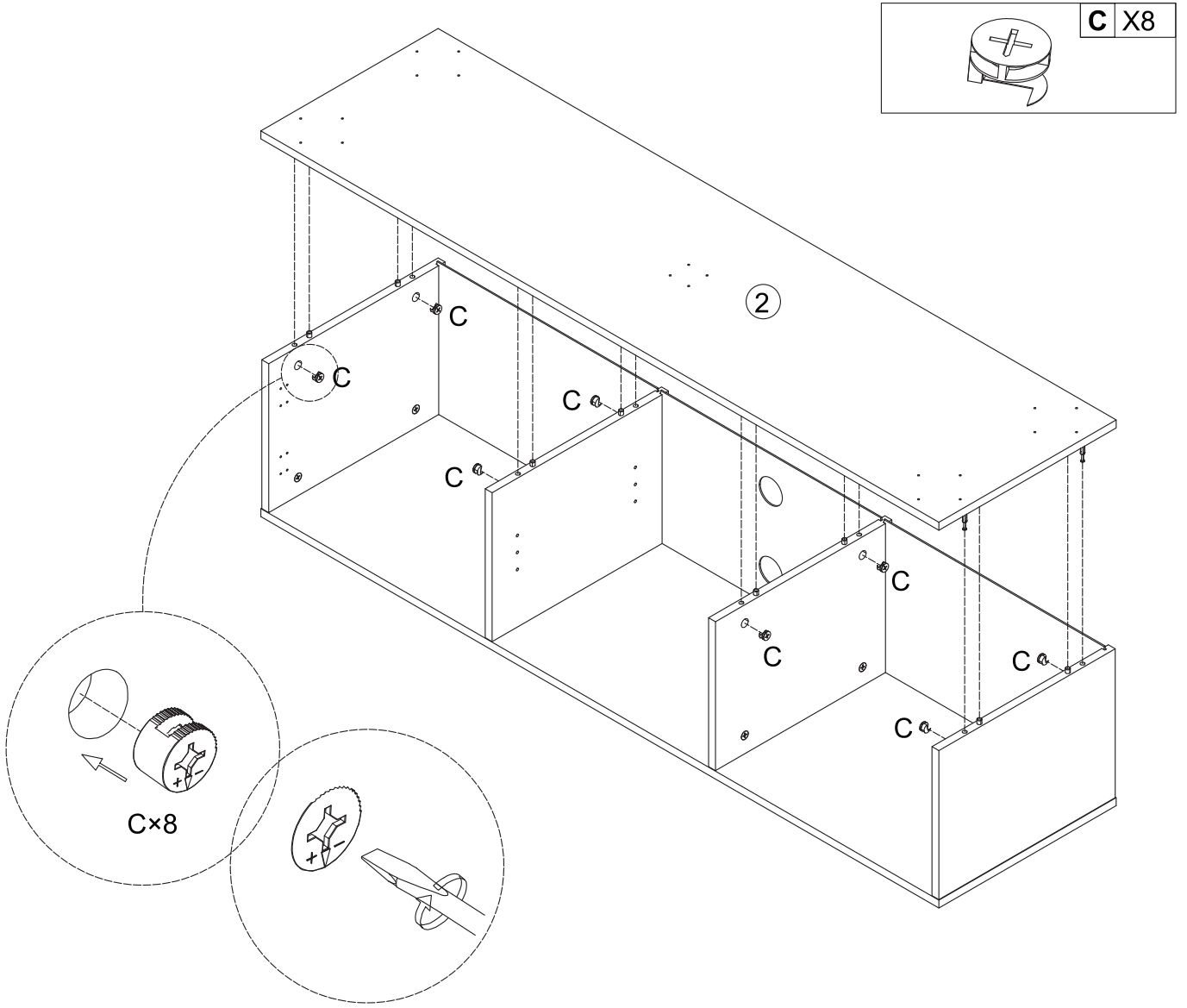

5.

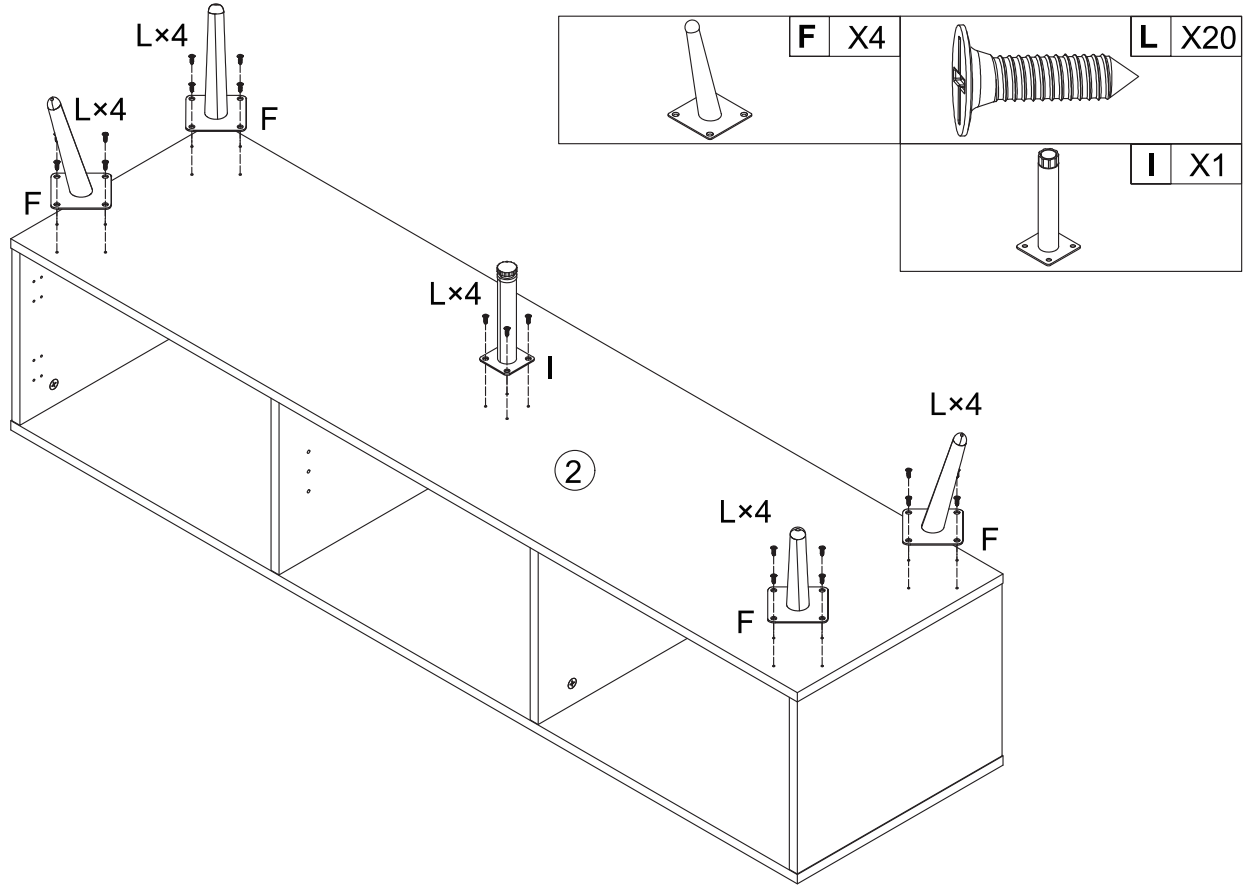

6.

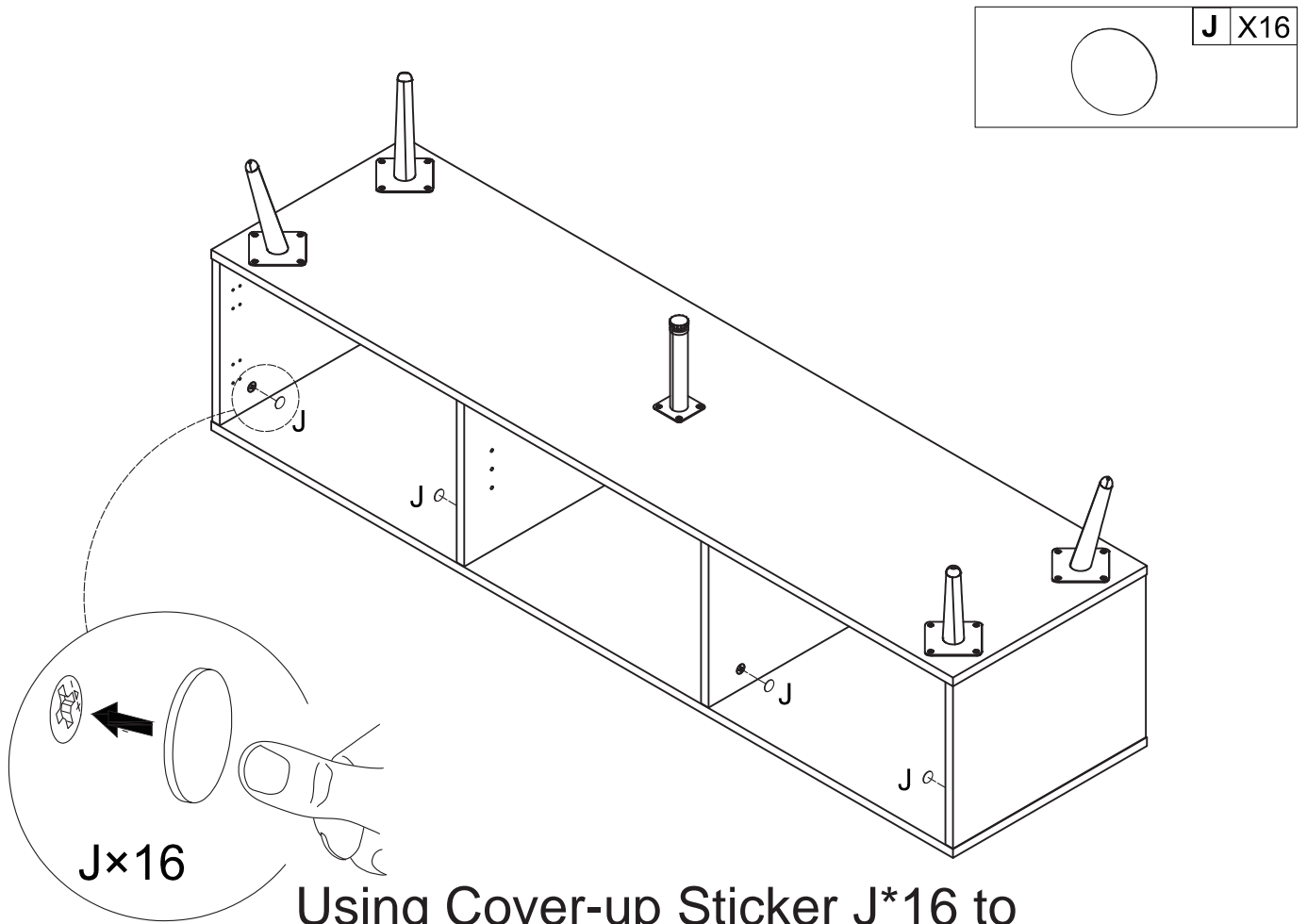

Using Cover-up Sticker J*16 to cover the exposed part of Screws.

7.

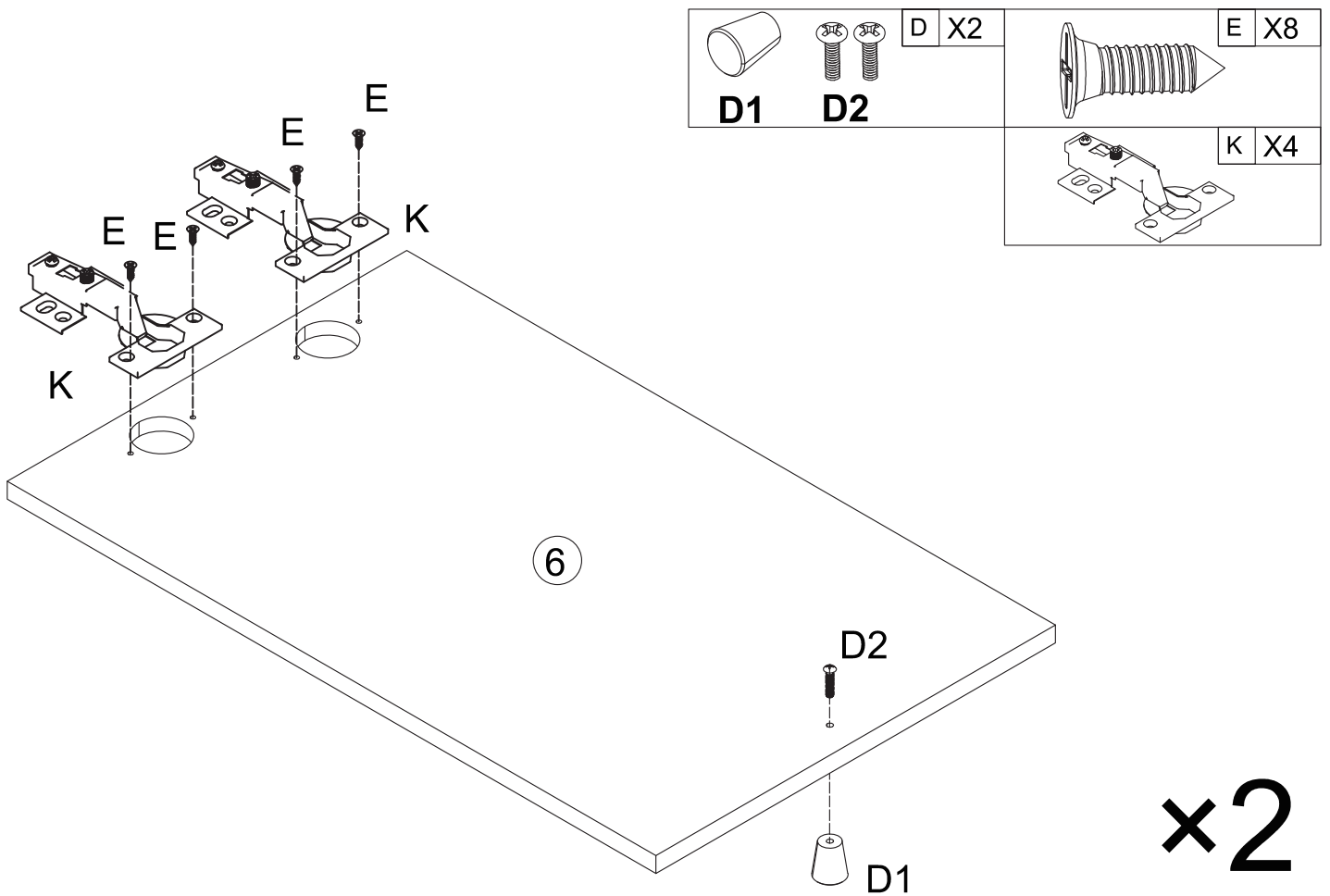

8.

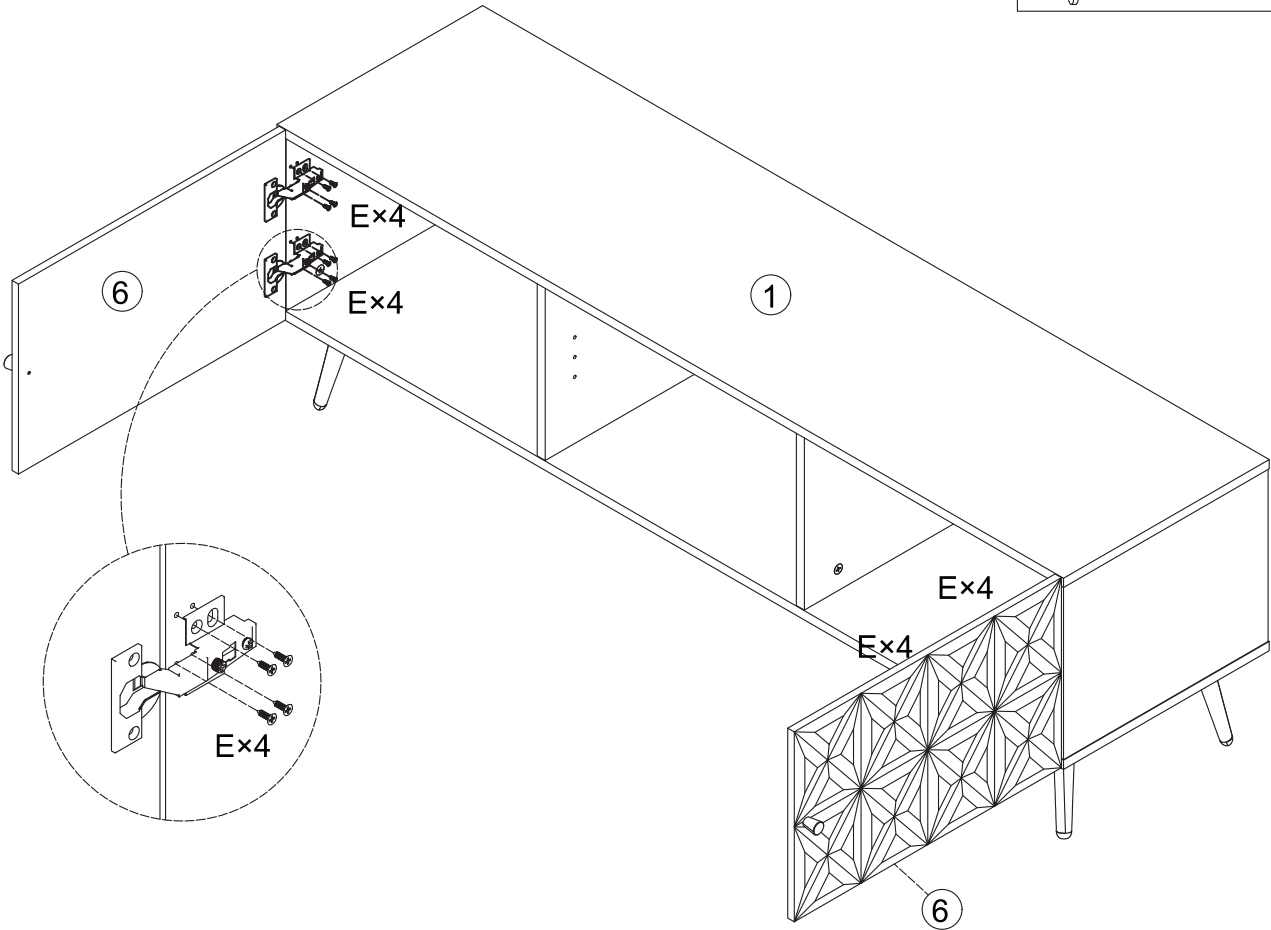
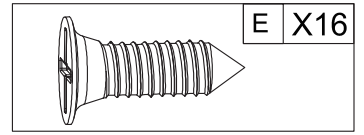

If the door can't close, please adjust the hinges.

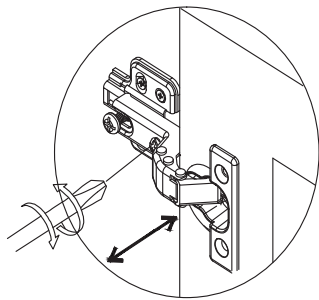

This is used to adjust the door panel in the up and down direction.

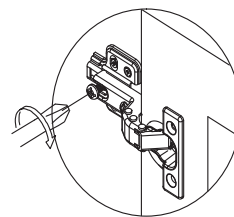
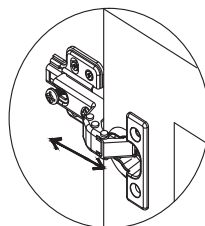
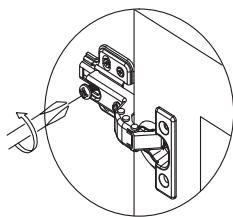

This is used to adjust the door panel in the front and back direction: Loosen the screw first, and then tighten screw after adjusting the door panel to the proper position.



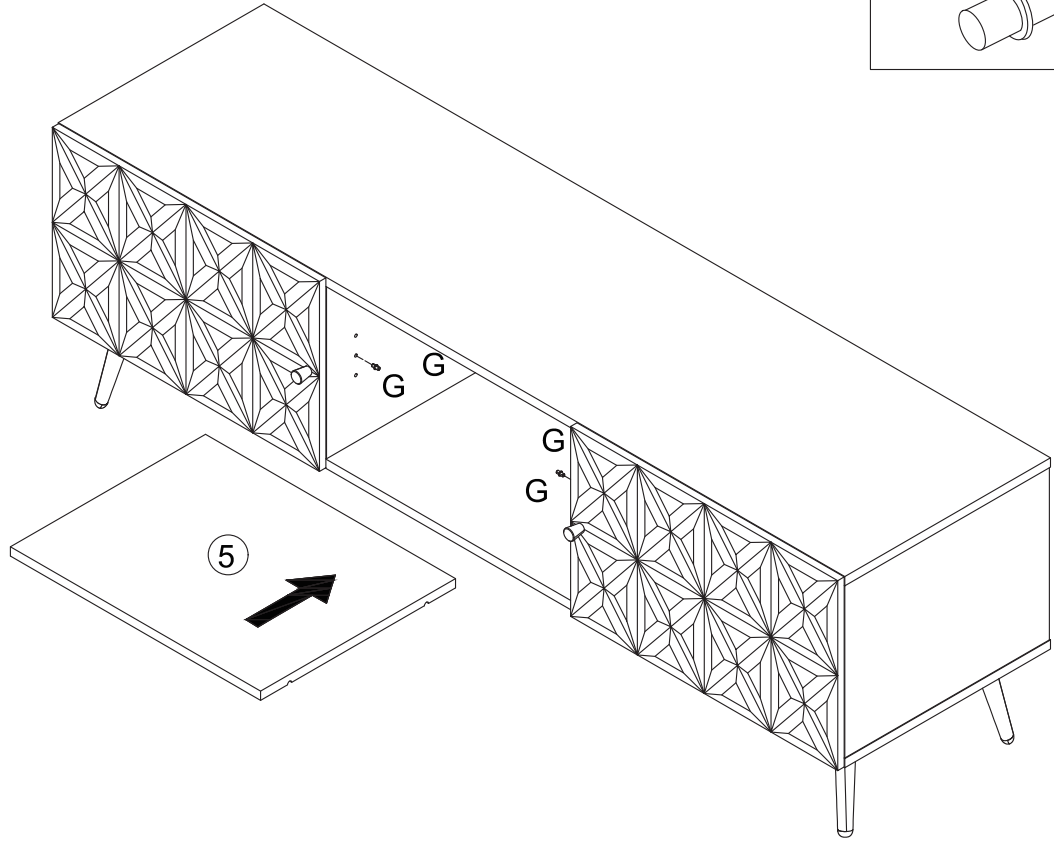

9.

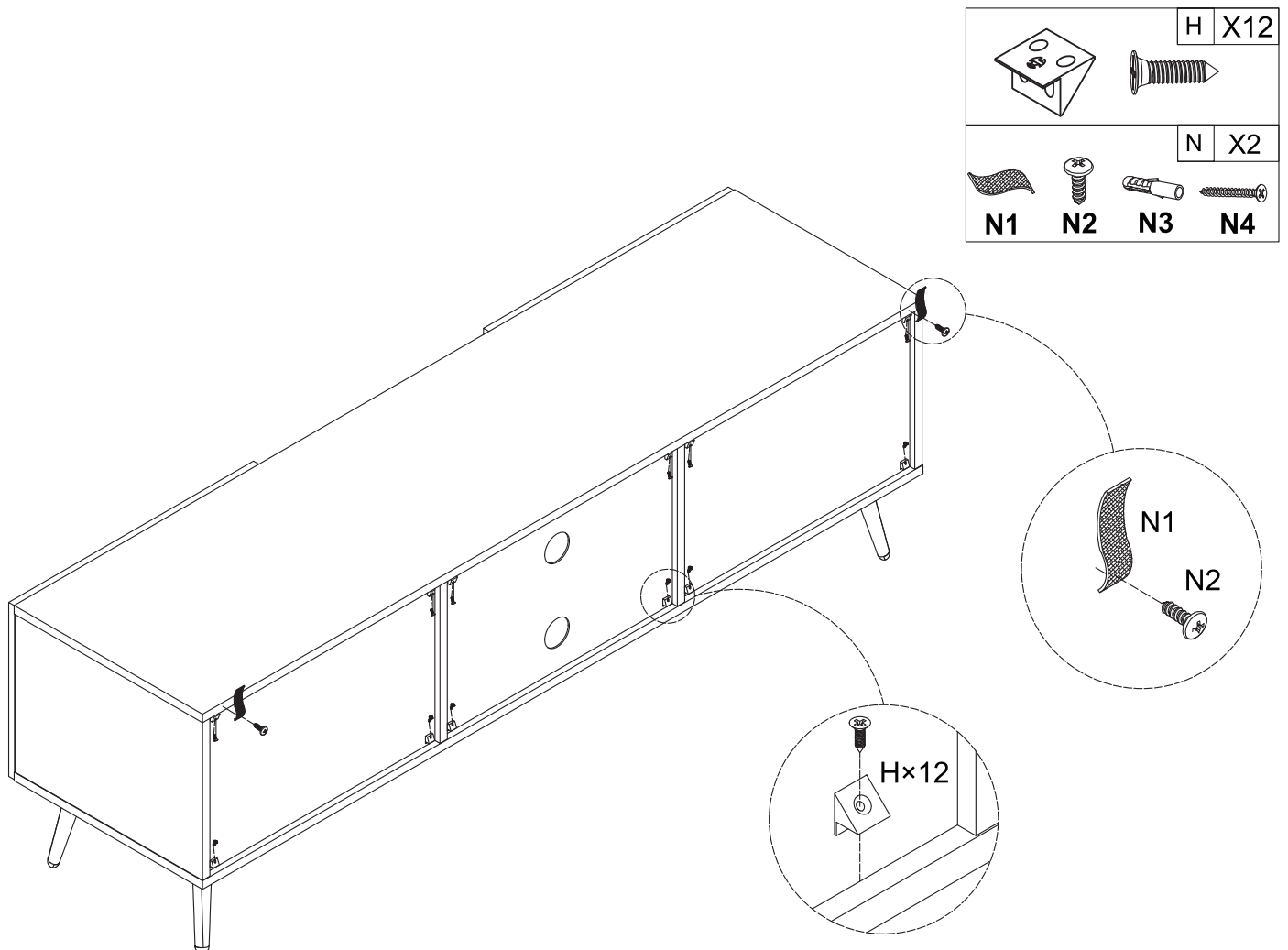

10.

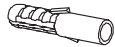

11.

			
N1	N2	N3	N4

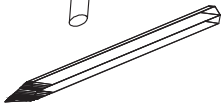
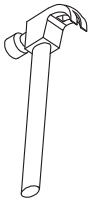
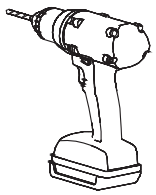

WALL



I x2

WALL +
drilling hole
Ø6x30mm



II x2

WALL

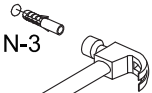

N-3

III x2

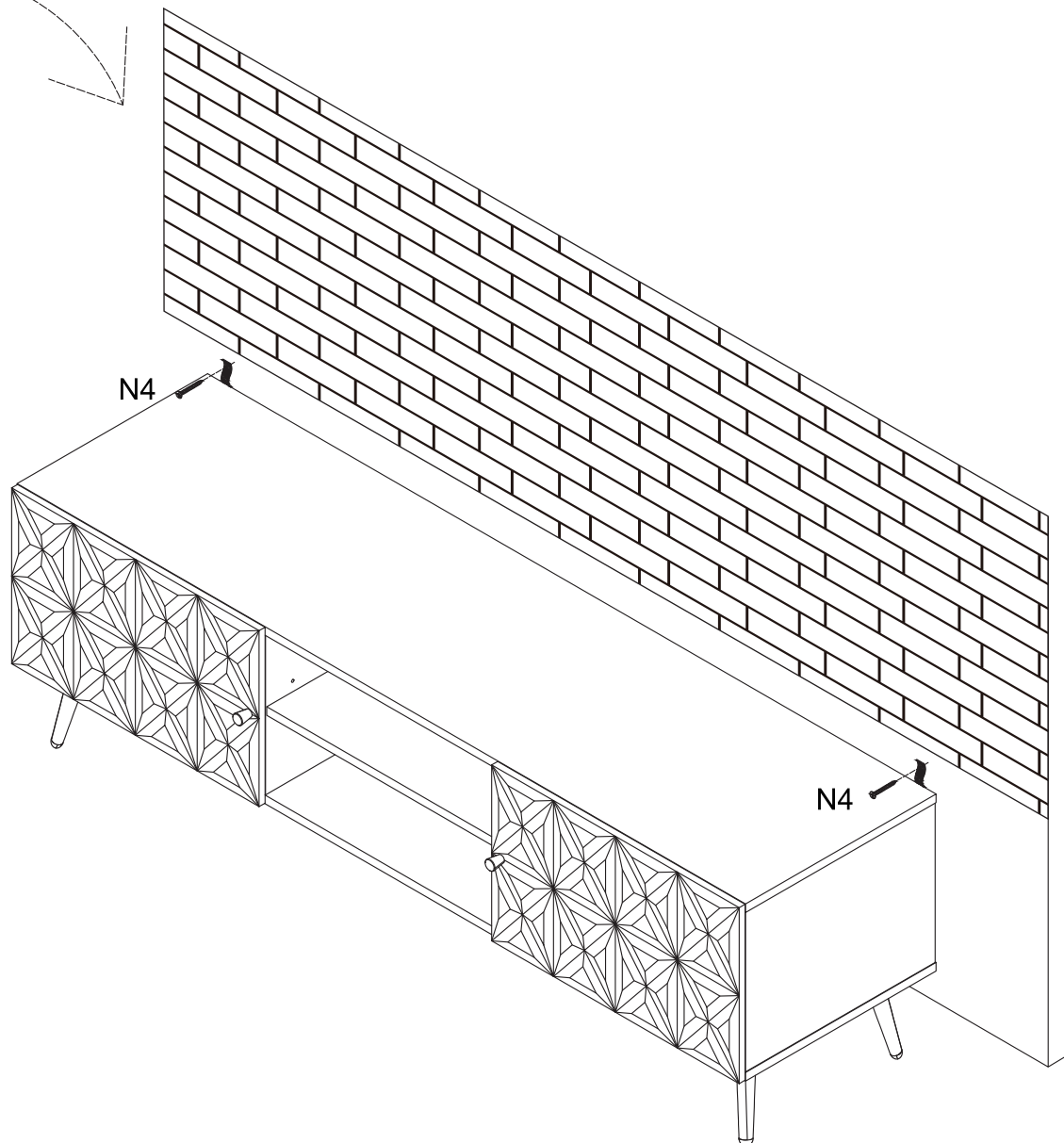

AFTER-SALE SERVICE

If you have any suggestions for our products or find that the products have quality problems, please contact us first, our after-sales team will reply you within 24 hours, and we will do our best to give you solutions until you are satisfied.

Guaranteed Customer Service

Your shopping experience is very important to us!
Feel unsatisfied? **Contact us!**
Have any questions? **Contact us!**

Wanna share your experience with our products?
Share your pictures with us.

Any suggestions? **Contact us!**
We gotcha back!