



**INSTRUCTIONS D'ASSEMBLAGE**  
**ASSEMBLY INSTRUCTIONS**

---

**LIT -**  
**QUEEN / BORDURE EN ARGENT TISSUS GRIS**



**BED -**  
**QUEEN SIZE / GREY LINEN WITH CHROME TRIM**



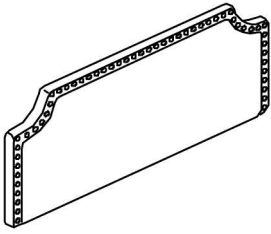
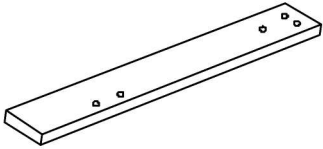
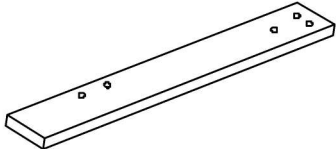
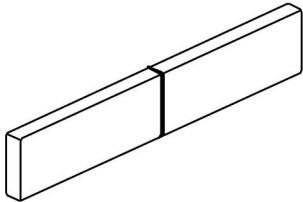
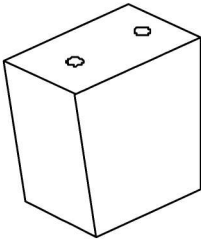

## LISTE DES PIÈCES PARTS LIST

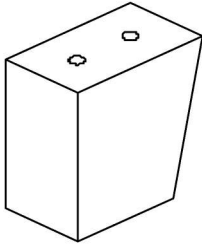
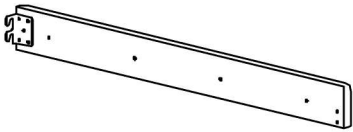
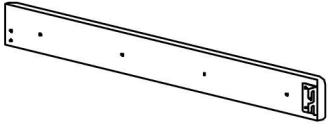
PIÈCE / PART #	IMAGE	DESCRIPTION	QTY / QTÉ
<b>1</b>		<b>HEADBOARD TÊTE DE LIT</b>	<b>1</b>
<b>2</b>		<b>FRONT FACING HEADBOARD LEFT LEG TÊTE DE LIT AVANT GAUCHE</b>	<b>1</b>
<b>3</b>		<b>FRONT FACING HEADBOARD RIGHT LEG TÊTE DE LIT AVANT DROITE</b>	<b>1</b>
<b>4</b>		<b>FOOTBOARD PIED DE LIT</b>	<b>1</b>
<b>5</b>		<b>FRONT FACING FOOTBOARD LEFT LEG PIED DE LIT AVANT GAUCHE</b>	<b>1</b>

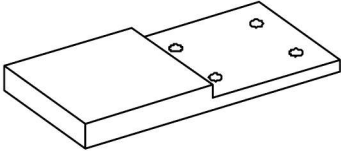

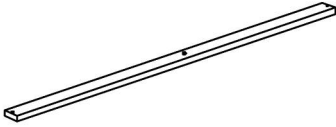

## LISTE DES PIÈCES PARTS LIST

PIÈCE / PART #	IMAGE	DESCRIPTION	QTY / QTÉ
<b>6</b>		<b>FRONT FACING FOOTBOARD RIGHT LEG PIED DE LIT AVANT DROIT</b>	<b>1</b>
<b>7</b>		<b>FRONT FACING LEFT SIDE RAIL RAIL DE CÔTÉ GAUCHE</b>	<b>2</b>
<b>8</b>		<b>FRONT FACING RIGHT SIDE RAIL RAIL DE CÔTÉ DROIT</b>	<b>2</b>
<b>9</b>		<b>SUPPORT BAR BARRE DE SOUTIEN</b>	<b>4</b>
<b>10</b>		<b>SIDE RAIL SUPPORT LEG RAIL DE CÔTÉ PATTE DE SOUTIEN</b>	<b>2</b>

**LISTE DES PIÈCES**  
**PARTS LIST**

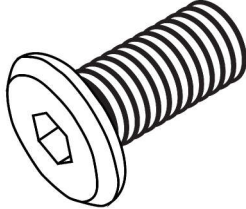
PIÈCE / PART #	IMAGE	DESCRIPTION	QTY / QTÉ
11		SLAT LAMELLE	4
12		SUPPORT LEG PATTE DE SOUTIEN	4

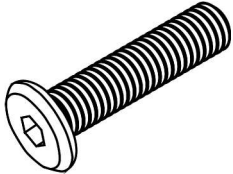
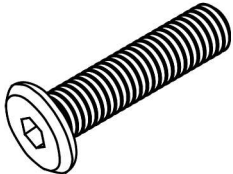
## LISTE DES PIÈCES DE MONTAGE HARDWARE LIST

PIÈCE / PART #	IMAGE	DESCRIPTION	QTY / QTÉ
<b>A</b>		ASSEMBLING BOLT - Ø 3/8" X 3/4" BOULON D'ASSEMBLAGE - Ø 3/8" X 3/4"	<b>8</b>
<b>B</b>		ASSEMBLING BOLT - Ø 1/4" X 1" BOULON D'ASSEMBLAGE - Ø 1/4" X 1"	<b>8</b>
<b>C</b>		ASSEMBLING BOLT - Ø 1/4" X 1 3/8" BOULON D'ASSEMBLAGE - Ø 1/4" X 1 3/8"	<b>20</b>
<b>D</b>		ASSEMBLING BOLT - Ø 1/4" X 2" BOULON D'ASSEMBLAGE - Ø 1/4" X 2"	<b>6</b>
<b>E</b>		ASSEMBLING BOLT - Ø 1/4" X 2 3/4" BOULON D'ASSEMBLAGE - Ø 1/4" X 2 3/4"	<b>2</b>

**LISTE DES PIÈCES DE MONTAGE**  
**HARDWARE LIST**

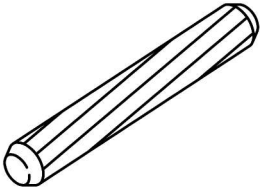
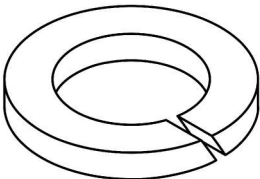
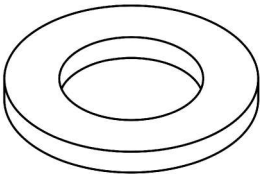
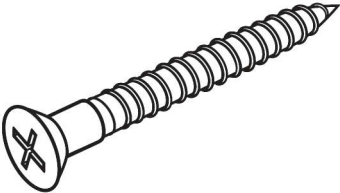
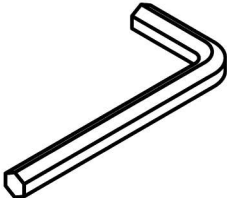
PIÈCE / PART #	IMAGE	DESCRIPTION	QTY / QTÉ
F		WOOD DOWEL GOUJON DE BOIS	2
G		LOCK WASHER ENTRETOISE DE MÉTAL	30
H		METAL WASHER RONDELLE DE MÉTAL	30
I		ASSEMBLING SCREW - Ø 1/8" X 1 1/4" VIS D'ASSEMBLAGE - Ø 1/8" X 1 1/4"	8
J		HEX KEY - M5, 4M CLÉ HEXAGONALE - M5, 4M	1

**LISTE DES PIÈCES DE MONTAGE**  
**HARDWARE LIST**

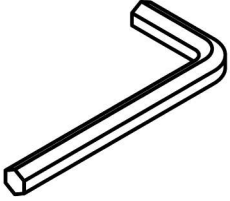
PIÈCE / PART #	IMAGE	DESCRIPTION	QTY / QTÉ
K		HEX KEY - M4 , 3M CLÉ HEXAGONALE - M4 , 3M	1

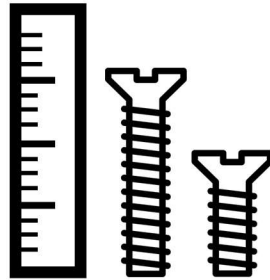

**OUTIL DE VÉRIFICATION DE DIMENSIONS DES PIÈCES  
HARDWARE DIMENSIONS VERIFICATION TOOL**

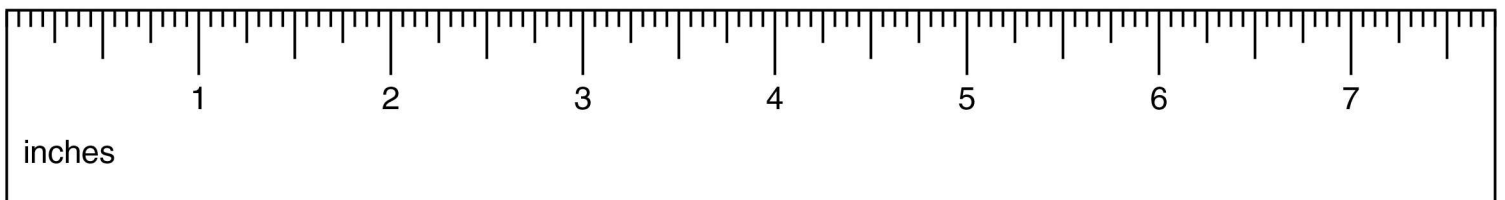

**ÉTAPE / STEP 1**

La quincaillerie et les composants sont situés dans l'unité de la tête de lit.

Hardware and components are located in the headboard unit.

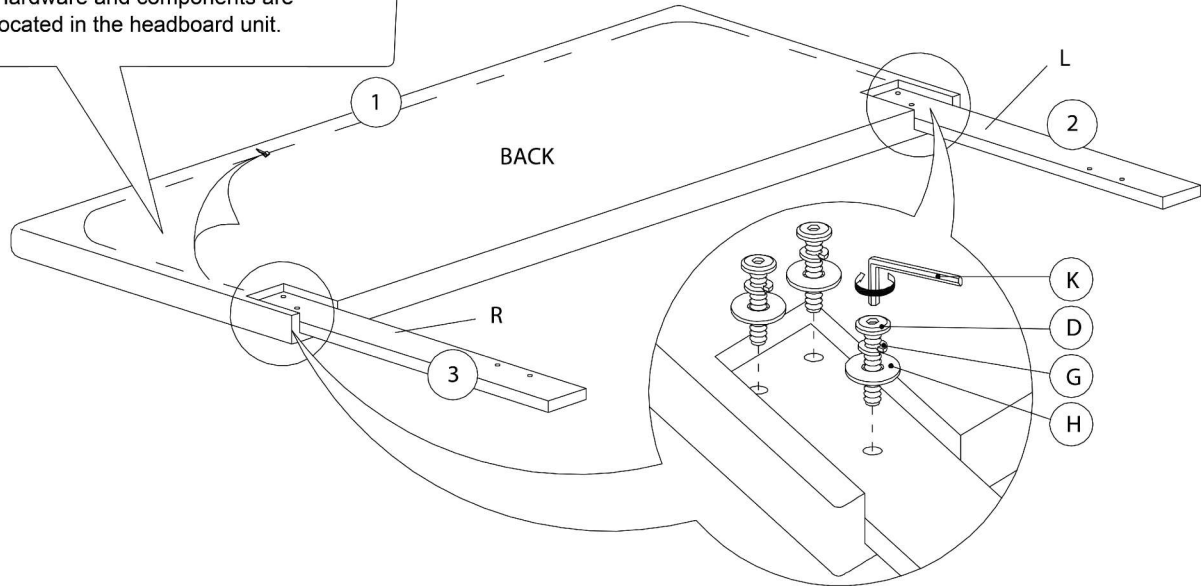

**ÉTAPE / STEP 2**

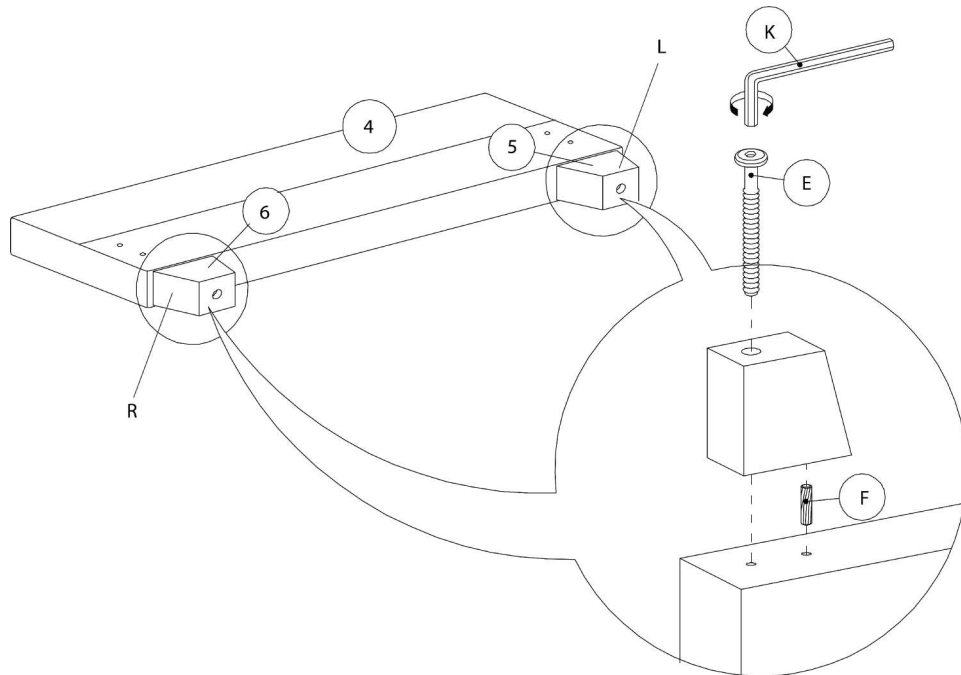

ÉTAPE / STEP 3

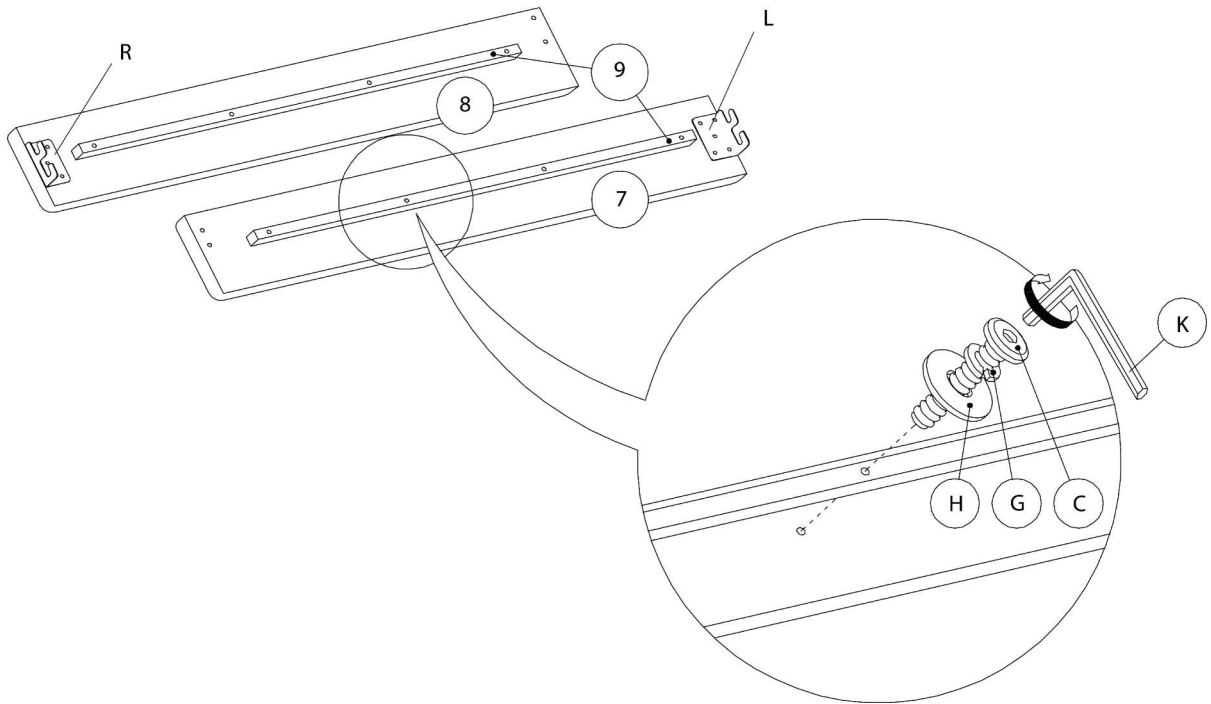

ÉTAPE / STEP 4

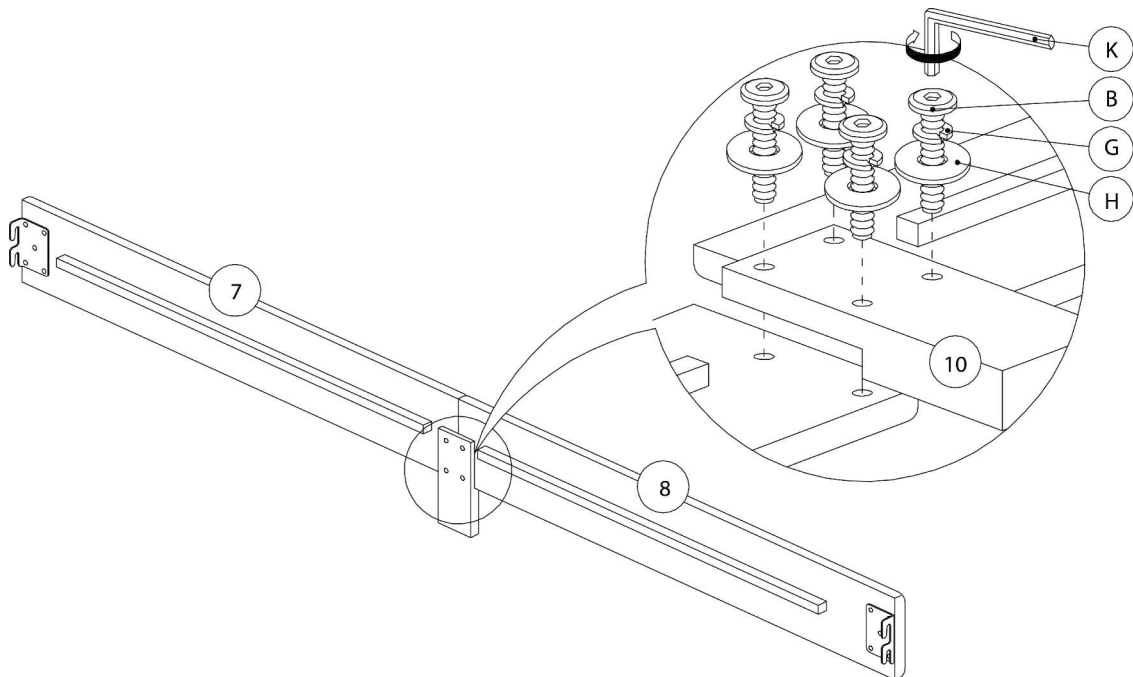

ÉTAPE / STEP 5

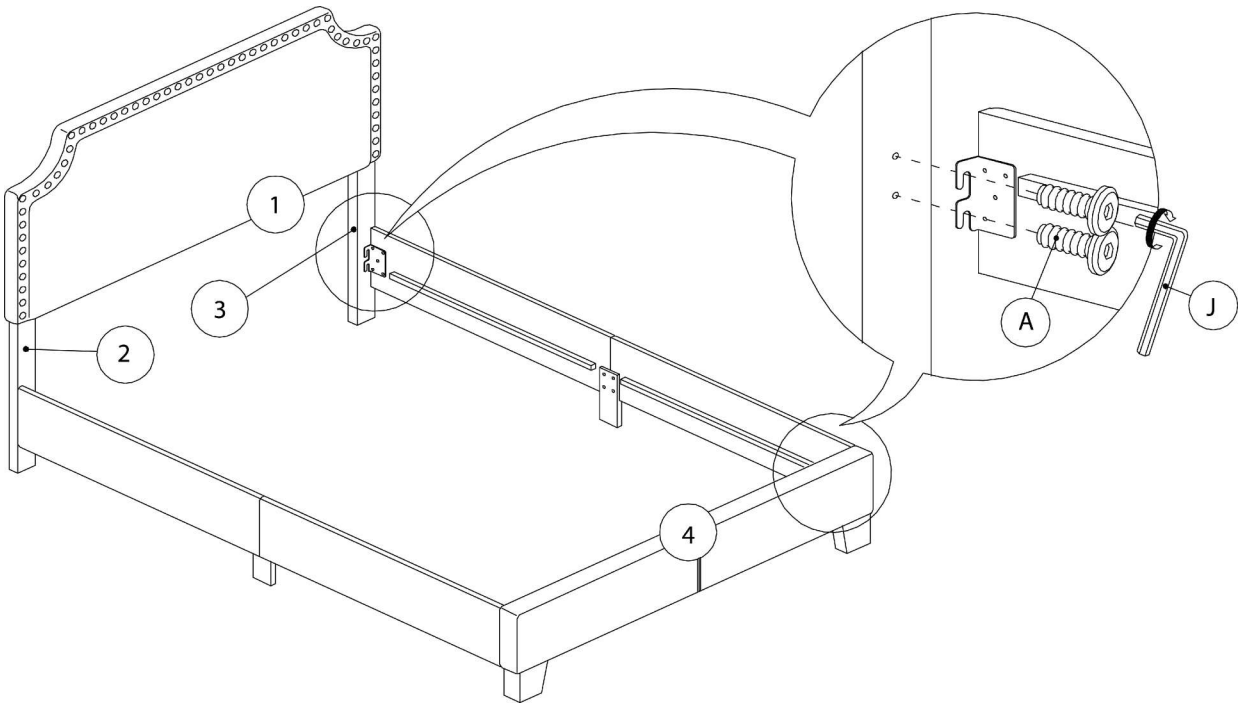

ÉTAPE / STEP 6

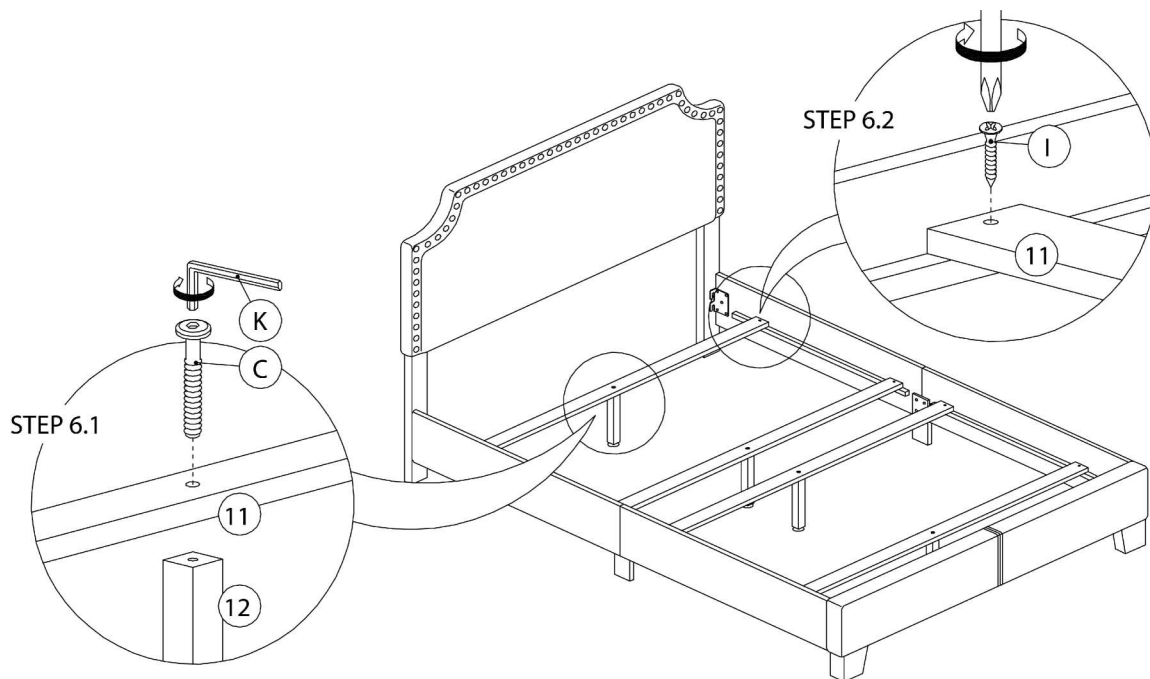

ÉTAPE / STEP 7

