

Patio Door Installation Guide

For 3-Panel Set

(3 Folding Panel)



Letter From the Manufacturer

Thanks for choosing the Bifold Patio Door from Ark Design. We hope you have a smooth installation after reading this manual.

To ensure an exact match for every bifold patio door, we **pre-assemble each door** in our factory, carefully adjust each one, and pre-drill holes for the hinges to ensure it's square and level so that all doors operate smoothly. Then the door is carefully disassembled, well packed, and delivered to your home in the safest and most cost-effective way.

Kind reminder for the installation:

- At least two people are needed for the operation. The door is very heavy and should be handled with extra care.
- Strictly follow the steps and always ensure it's level and plumb when required. This will provide the best user experience.
- The Installation Guide is for **Right** Opening. If you purchase **Left** Opening, start from the other direction from Page 7.
- We are always here to help. Feel free to contact dooraftersale@gmail.com if you have any questions.

You will Receive 4 Parcels in Total

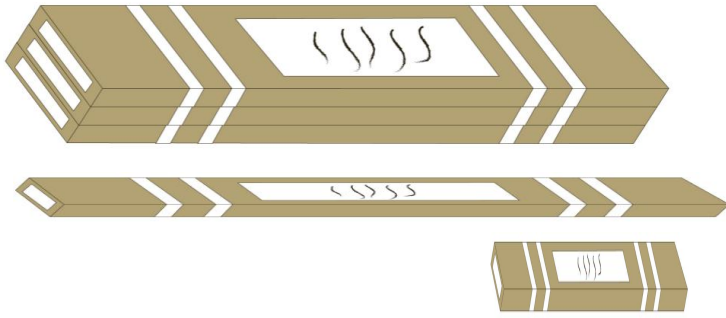

Door Panel Parcel x3

Jamb Parcel x1
Hardware Box x1

Jamb & Hardware Package x1, including

6 Jamb Pieces:

Left Jamb x1; Right Jamb x1; Header Jamb x2; Bottom Rail x2

(Header and bottom has been cut to half for safer transportation. Connection plates is provided in the packages)

Hardware List:

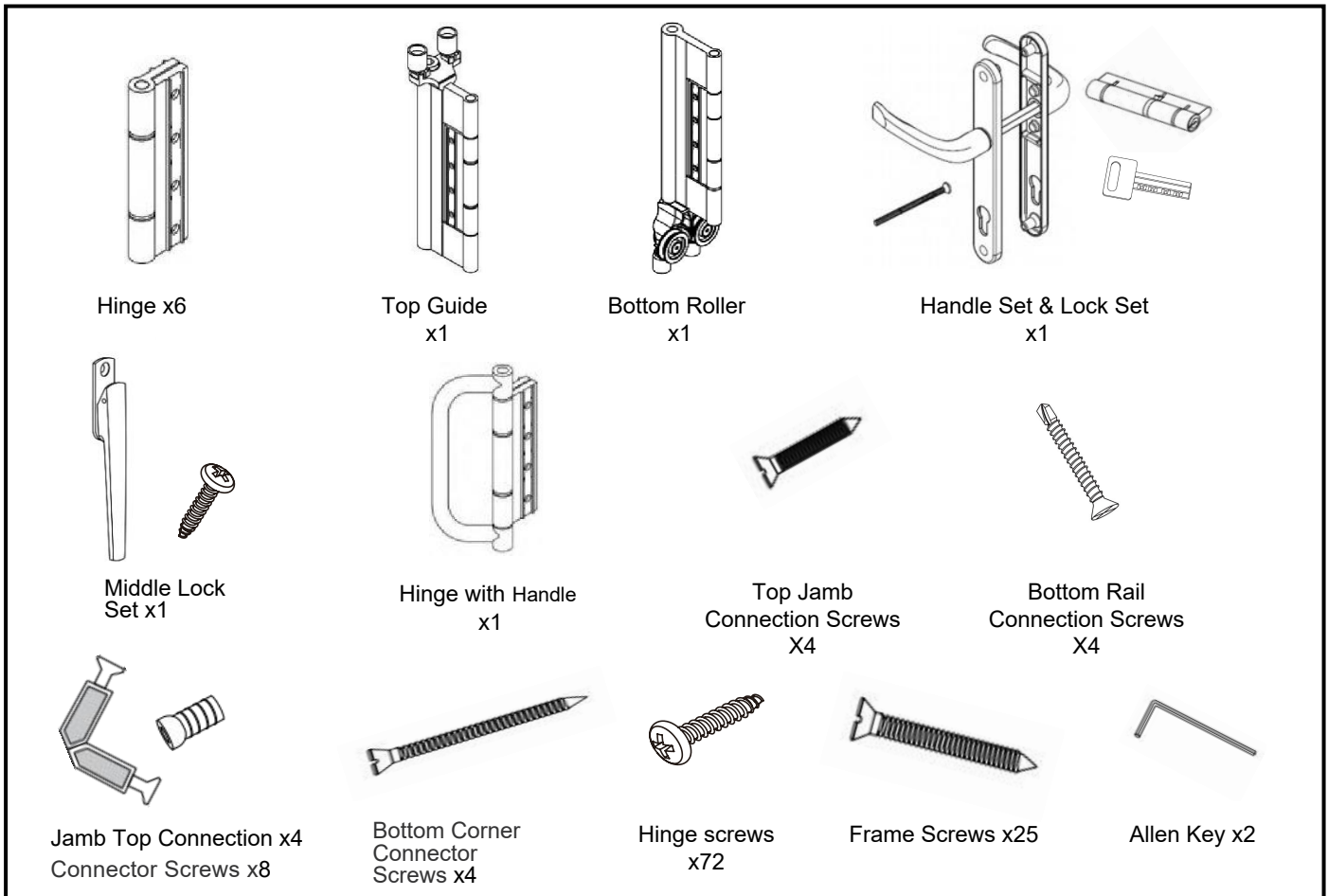

Tools Required



Screw Driver



Tape



Level



Driller

Preparing the Site

Brickwork Opening

When preparing the site, please prepare the brickwork opening to be same as the option you purchase. For example, if you purchase a 96" x 80" door, prepare the opening to be exactly 96" x 80". The door frame will be 9/16" shorter in width and height so that you can fit in the opening and seal properly.

It is essential that all 4 internal surfaces of the brickwork be levelled before installation. Please ensure that all dimensions are correct for installation before proceeding, as the set must be installed square, upright and level into the opening.

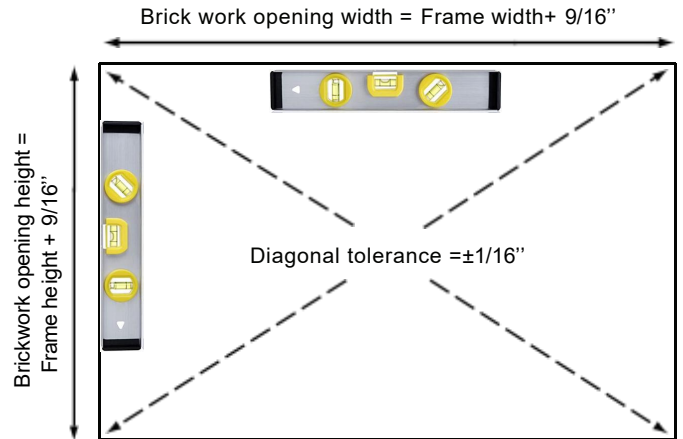

Assembly the Frame

Connect Header and Bottom Rail

Header

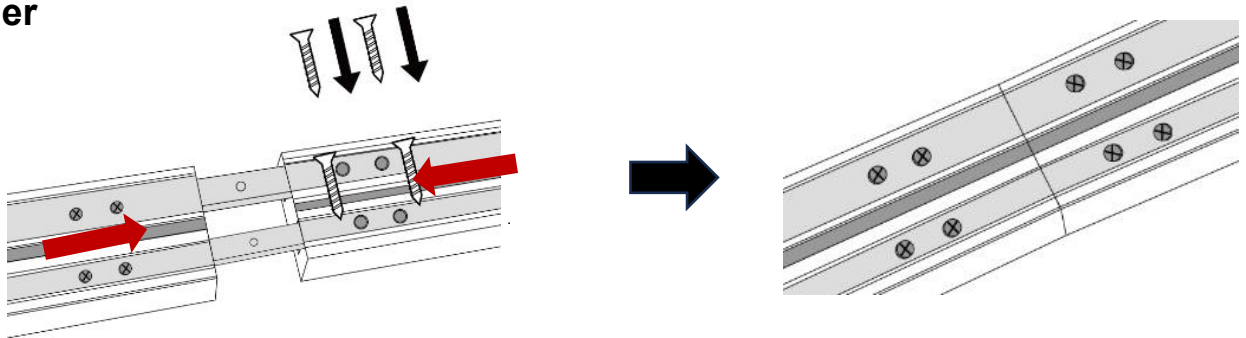

Bottom Rail & Sliding Slope

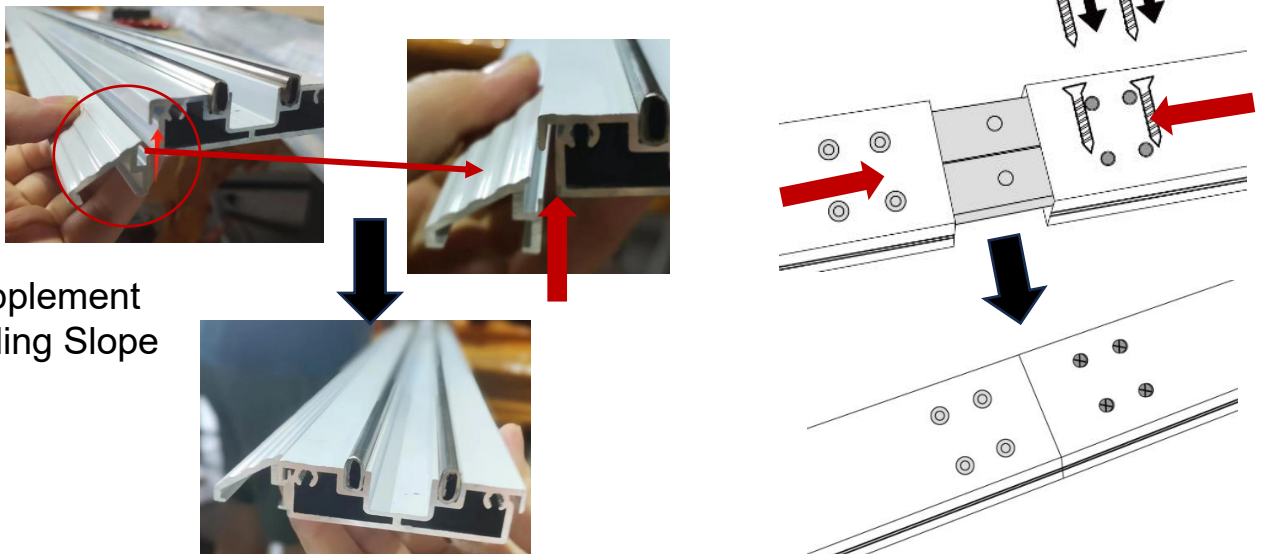

Slide the header and rail together with the connection plate embedded in the frame. Fasten the connector with provided screws.

For bottom rail. We provide supplement sliding slope for accessible pathway. Follow the above steps to install the sliding slope on both sides.

Assembly the Frame (Cont.)

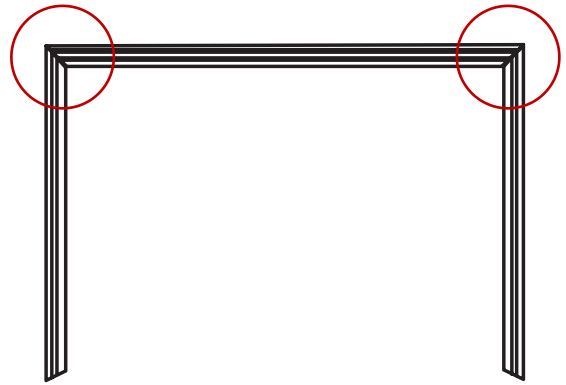
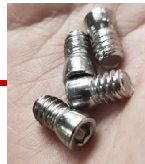
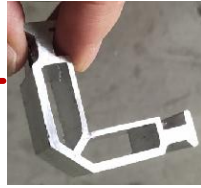
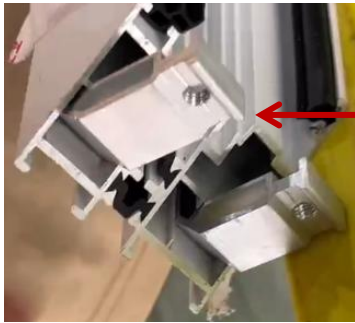

- Insert Jamb Top Connection to the top jamb, attach the side jamb to the other side of the Connection
- Fasten the 4 screws with Allen Key
- Conduct the steps on 2 top corners to form the above frame

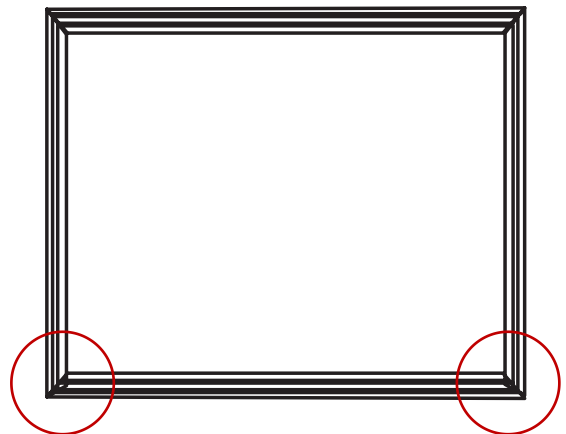
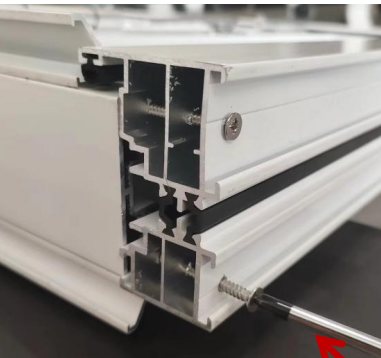

- Use the Bottom Corner Connector Screws to attach the side jamb with bottom rail
- Conduct the steps on 2 bottom corners to form the full frame

Pro tip: Find the indoor and outdoor side for the frame



Indoor Side

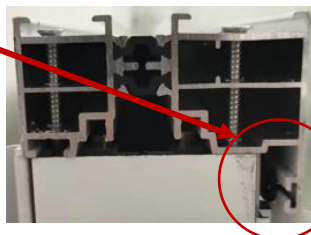

Outdoor Side

- Take a look at the side or top jambs.
- The jambs with longer wing as circled out in the picture are indoor side. This is to prevent rain from falls in.

Install the Frame

1

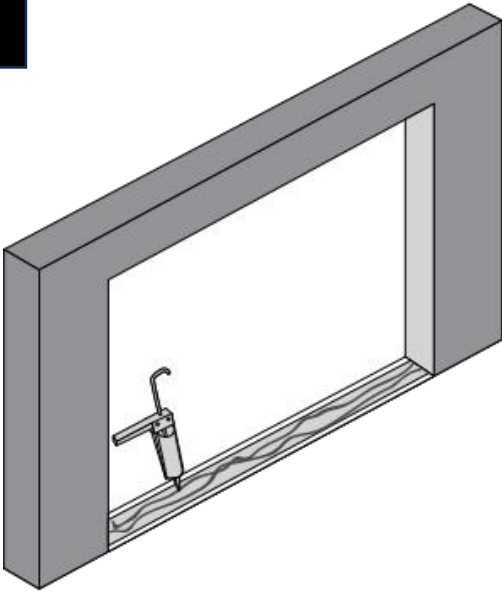

- Place the liquid nail under the track

2

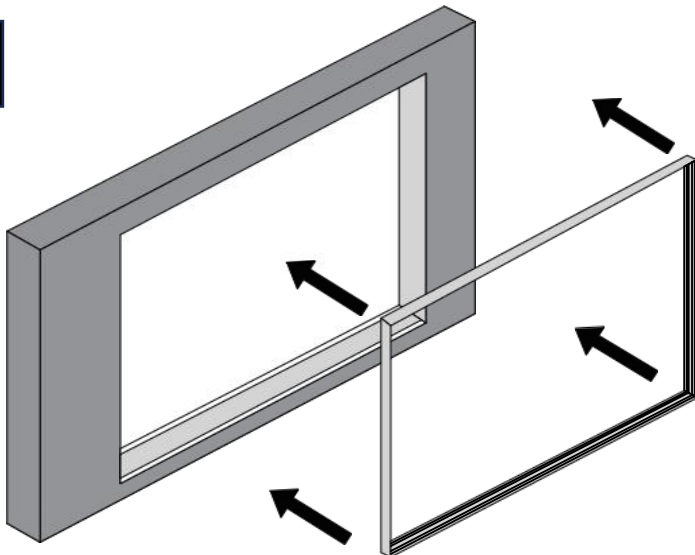

- Put the frame in. Make sure the frame is level and plumb

3

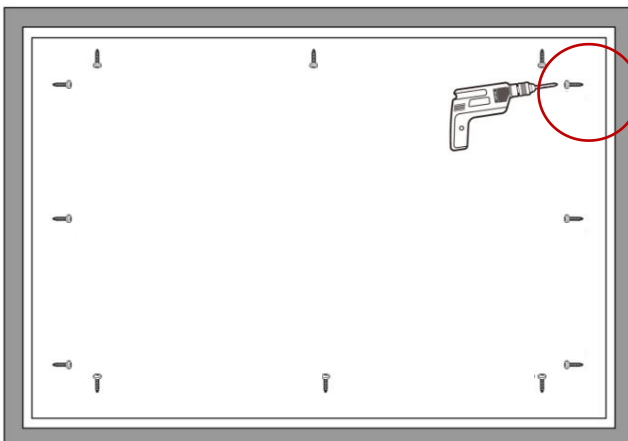

- Use the provided frame screw nail to drill through the frame to the wall. We recommend screw spacing of 20" (extra screws are provided in packages)

Pro Tip: Understand Door & Hardware Position

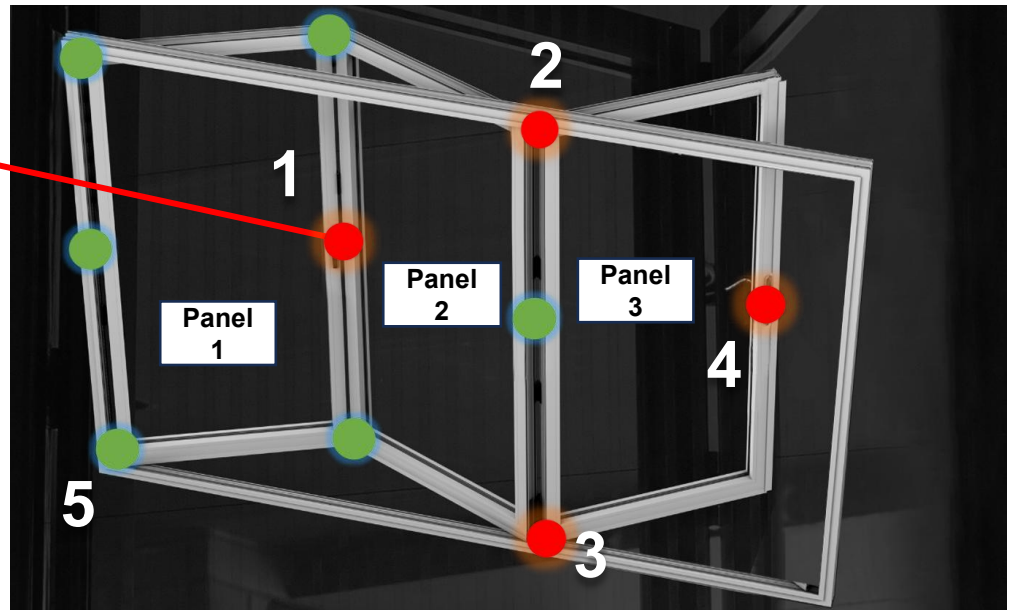

1. Middle Lock Set + Hinge with Handle
2. Top Guide
3. Bottom Roller
4. Handle Set & Lock Set
5. Hinge (6 in total)

Pro tip: Position the Door Correctly According to Label

Face This Side Inside
Put This Side Upward



This is the ③ Door Panel
PPDW0300R9680-3

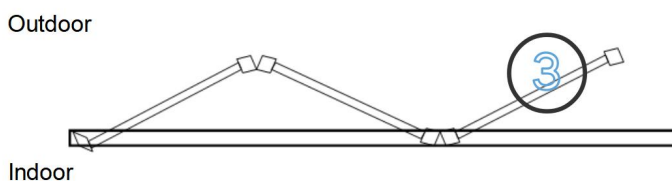

You will find this **door label** on **every door panel**. You can read door **panel #**, which side faced **indoor**, and which side **face upward** based on the label

Install Folding Door Panels (Right Opening As an Example)

1

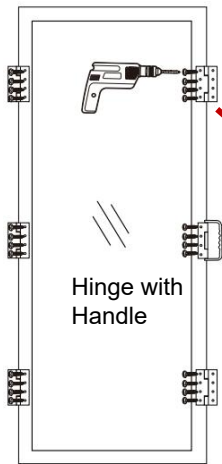

- Attach 5 hinges and 1 hinge with handle to **Panel 1**

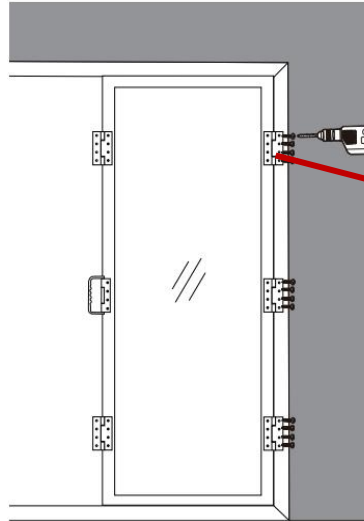

- Attach the **Panel 1** to the frame using the other side of the hinges

2

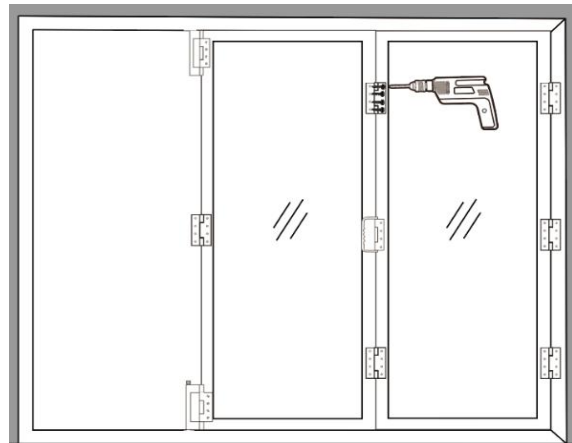
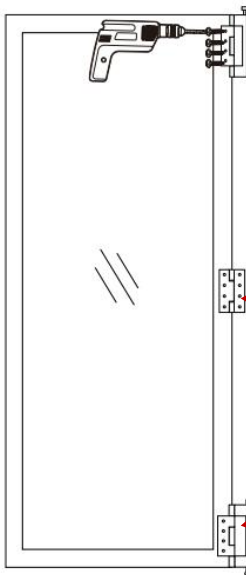

- Install the top and bottom roller, and a hinge to **Panel 2**
- Put the top and bottom roller in the track. Connect the **Panel 1 and Panel 2** with the hinges already installed on the **Panel 1**

3

- Connect the **Panel 2** to **Panel 3** with the already installed top and bottom roller and hinges on the **Panel 2**

Pro tip:

- Examine whether the 3 doors are level
- You can adjust the height of panels by the bottom roller illustrated as below with a wrench

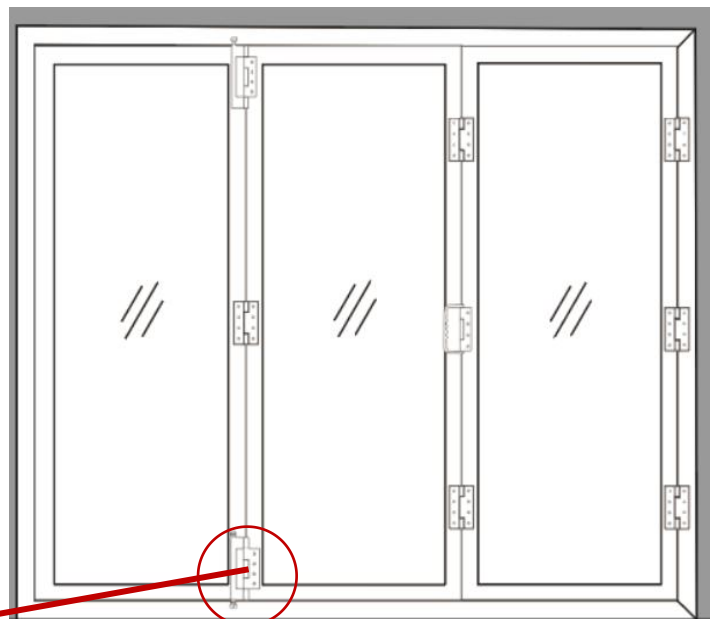
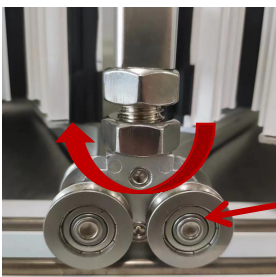

Install Locks

Middle Lock



- Rotate the lock to reveal screw holes
- Fasten to door with provided screws



Handle Set & Lock Set

