

ASSEMBLY INSTRUCTIONS



CAUTION

◆ Inspect the wire insulation for any cuts, abrasions, or exposed copper that may have resulted during shipping. If there is a defect in the wire, do not attempt installation.

◆ Before starting installation of this fixture or removal of a previous fixture, disconnect the power by turning off the circuit breaker or by removing the fuse at the fuse box.

TOOLS REQUIRED



Ladder



Safety glasses



Electrical tape



Phillips screwdriver



Flat blade screwdriver



Pliers

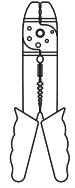

Wire strippers

HARDWARE INCLUDED

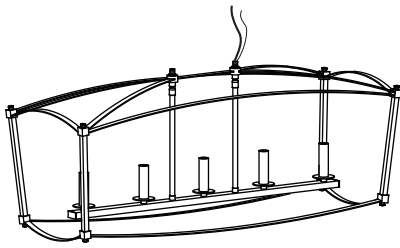

Fixture

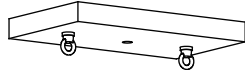

Ceiling Plate



Mounting Unit



Nut



Cap Nut

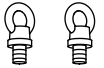

Hanging Rings

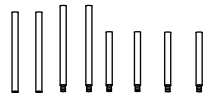

Stem(A-D)



Chains



Mounting Screws



Wire Nuts

***PARTS SHOWN MAY DIFFER SLIGHTLY PER LIGHT FIXTURE**

EXPLODED PARTS

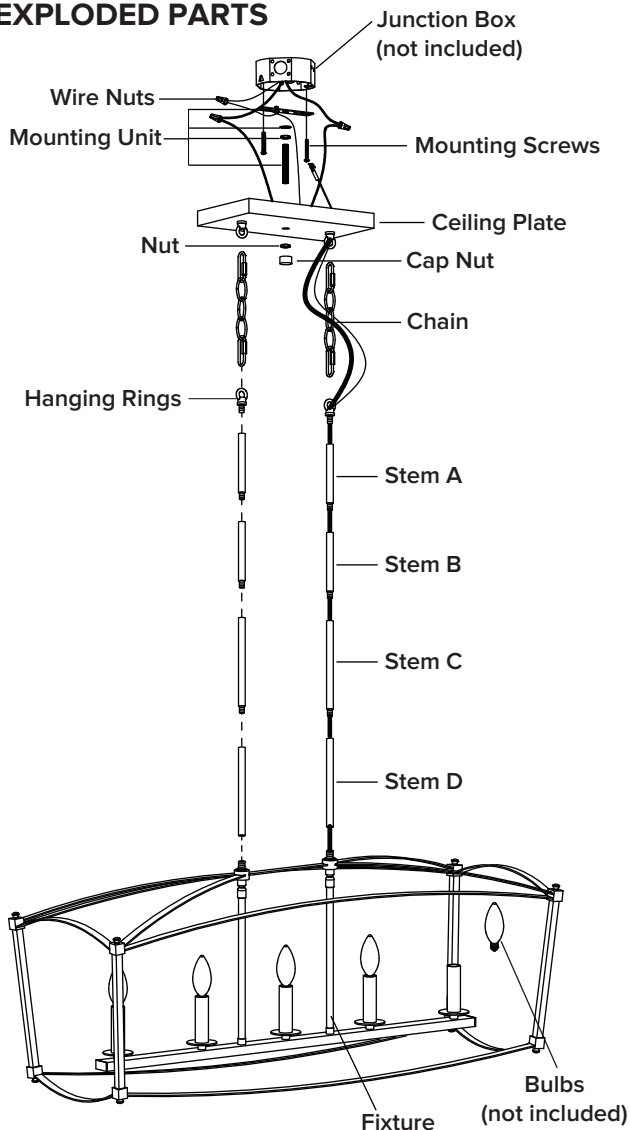

INSTALLATION

STEP 1

1. Unscrew the **nut** and **cap nut** from the **mounting unit**. Use the **mounting screws** to attach the **mounting unit** to the **junction box** (not included).

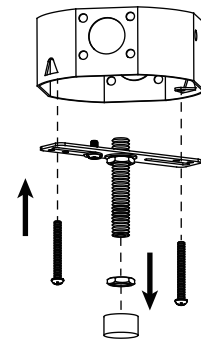

STEP 2

1. Choose the length of the **stem** you need. Weave the fixture wire and fixture ground wire through the **stem(A-D)** and **Hanging Rings**.

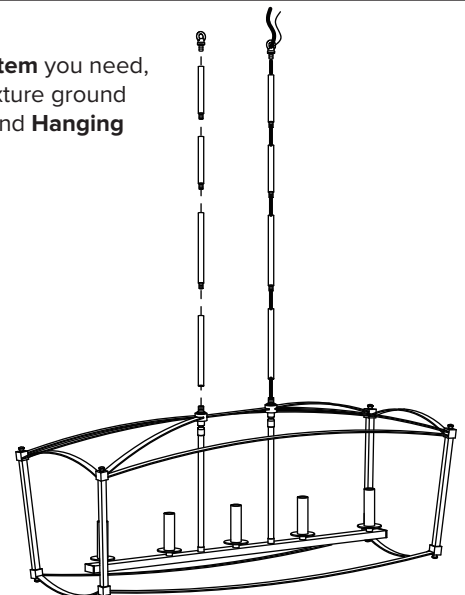

ASSEMBLY INSTRUCTIONS (INSTALLATION)

STEP 3

1. Choose the length of the **chain** you need (Open the chain using a phillips screwdriver (not included) and pliers (not included)).
2. Open the quick link. Then attach it to the **fixture finial** and **ceiling plate**. Close the quick link.

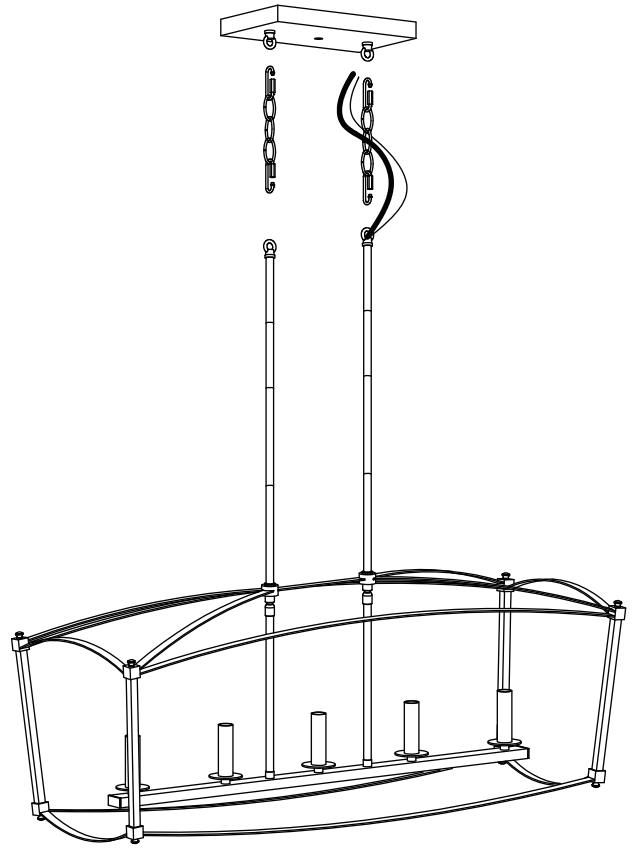
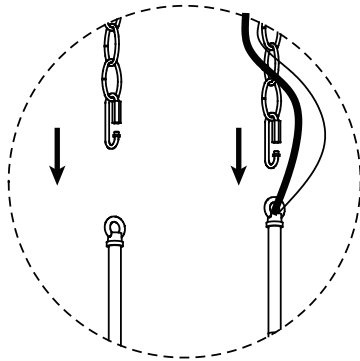
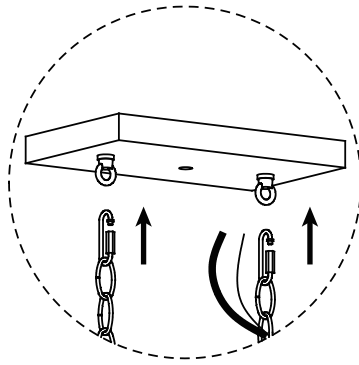
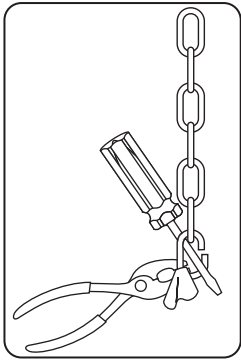

STEP 4

1. Attach the lanyards on to the mounting unit.
2. Make the electrical connection from the junction box (not included) to the **fixture**. Connect the **ground wire** to the **mounting unit** using the preinstalled green ground screw. Next, connect the live wire, neutral wire and ground wires with the supplied **wire nuts**. Secure with electrical tape.

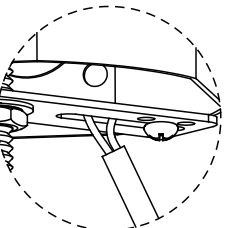
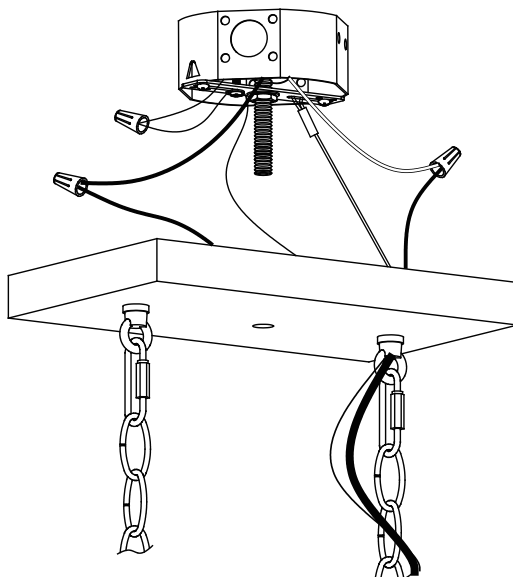
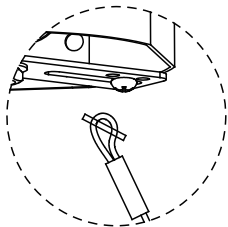
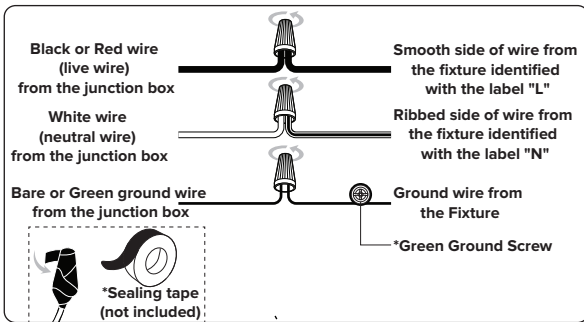

STEP 5

- Attach the **ceiling plate** to the **mounting unit** through screw holes as shown, and secure it with **nut** and **cap nut**.

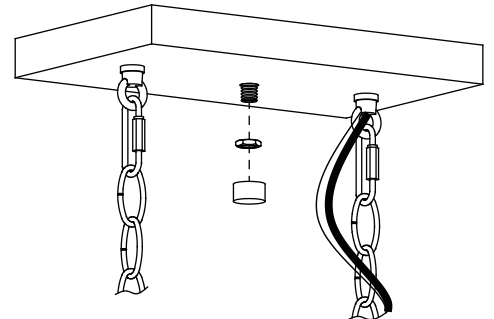

STEP 7

- Install bulbs (not included)

