

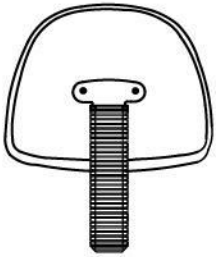

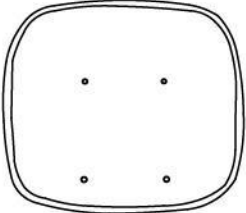

**IMPORTANT NOTICE:
HARDWARE PACKAGE IS ATTACHED
ON THE BOTTOM OF SEAT CUSHION.**

(1)x1  Back Cushion Back Support W/ Bellow	(2)x1  Seat Cushion	(3)x1  mechanism
(4)x 1  Nylon Base	(5)x1  Gas Lift	(6)X1(L) X1(R)  Arms
(7)X1  Knob/Knob	(8)X5  Casters	
(A)*4  Mechanism Screws (B)*6  Arm Screws		

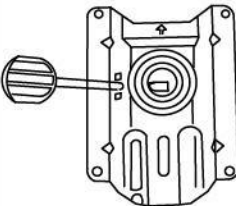

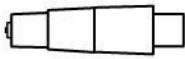
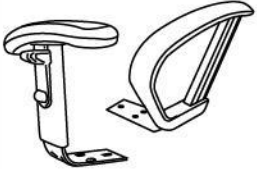
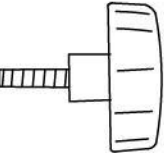
Insert and loosely tighten all screws. When assembly is completed, fully tighten all screws before using. This chair is only intended for sitting. Any other use will void the warranty.

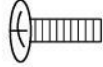
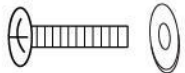
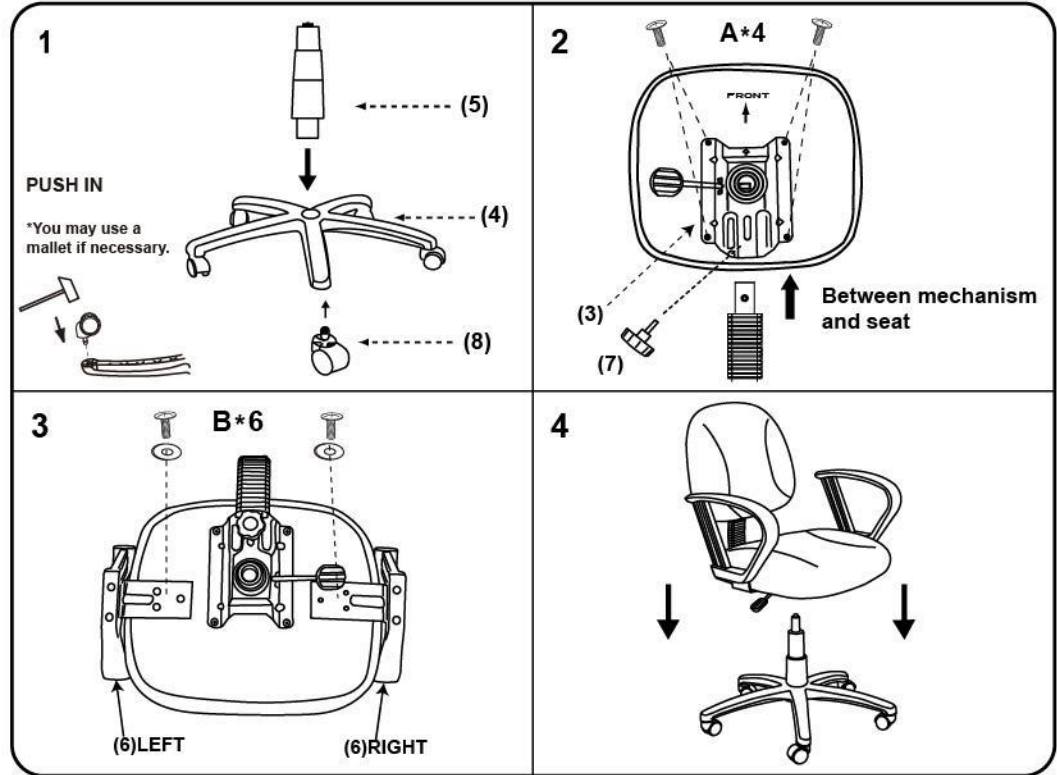