

1870100569

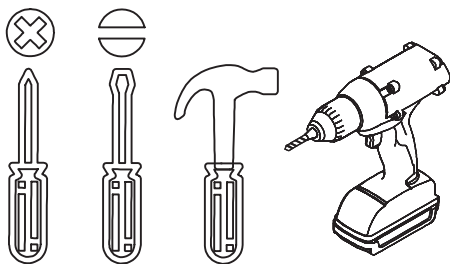

**Tools required
(not included)**

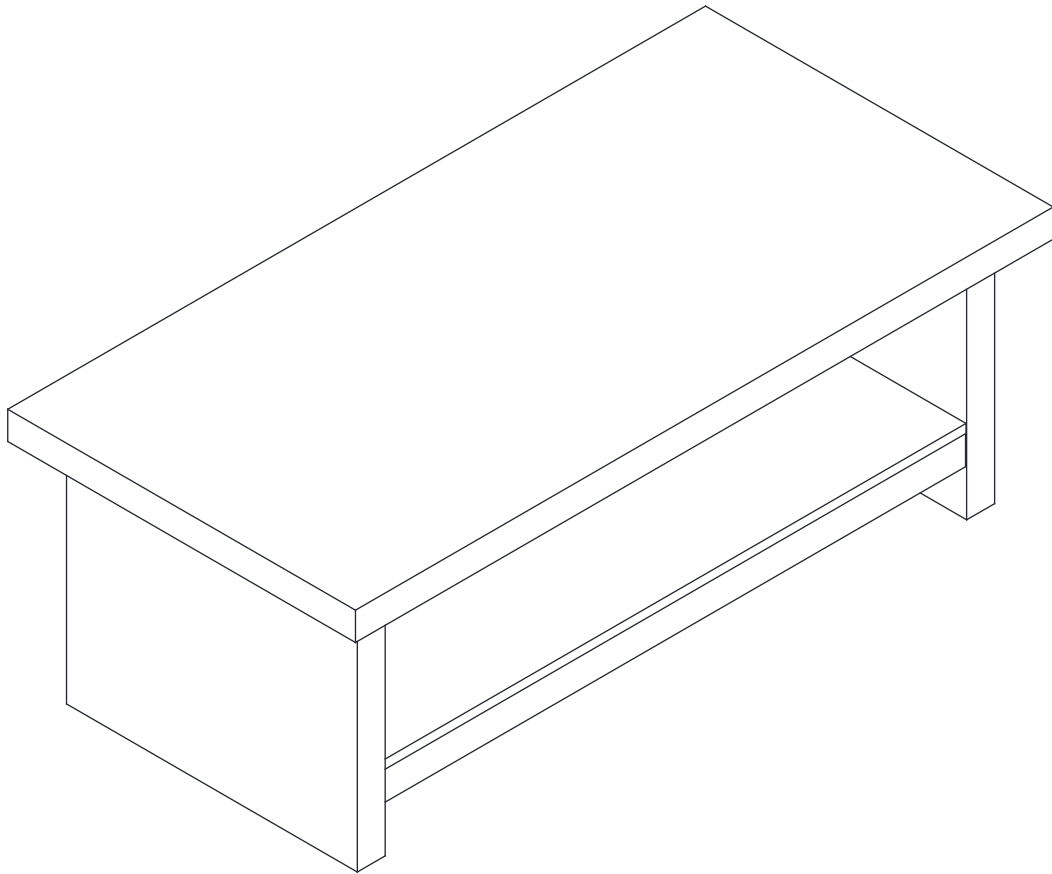
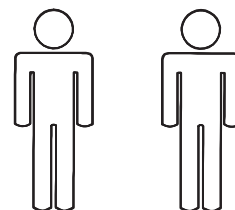

2 people for assembly



Safety and Care Advice

Important – Please read these instructions fully before starting assembly

- Check you have all the components and tools listed on the following pages.
- Remove all fittings from the plastic bags and separate them into their groups.
- Keep children and animals away from the work area, small parts could choke if swallowed.
- Make sure you have enough space to layout the parts before starting.

- During assembly do not stand or put weight on the product, this could cause damage.
- Assemble the item as close to its final position (in the same room) as possible.
- Assemble on a soft level surface to avoid damaging the unit or your floor.
- Parts of the assembly will be easier with 2 people.



- To reduce the likelihood of damaging your product please ensure that your power drill is set on a low torque setting.

Care and maintenance

- Only clean using a damp cloth and mild detergent, do not use bleach or abrasive cleaners.
- From time to time check that there are no loose screws on this unit.
- This product should not be discarded with household waste. Take to your local authority waste disposal centre.

Handy Hints

- Assemble all parts and bolts loosely during assembly, only once the product is complete should you fully tighten the bolts
- Regularly check and ensure That all bolts and fittings are tightend properly.

WARNING In order to help prevent overturning – please follow these instructions

To help prevent product toppling over please follow the below steps:-

Use the anti tip stap or wall fixing method provided (if applicable)
Do not allow children to climb or hang on the furniture
Do not open more than one drawer at a time
Do not place heavy items in the top drawers
Do not place heavy items on top of the furniture, unless the furniture has been designed for this purpose

please note that only the anti tip strap is provided.
You will need to provide wall plugs and screws applicable for your wall type

Using Camlocks

Step 1

Connect the male camlock as directed in the assembly instructions using a screwdriver.

1

DO NOT OVER TIGHTEN.
NE PAS SERRER EXCESSIVEMENT.

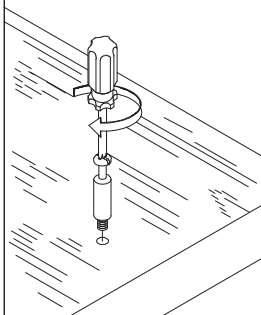

Step 2

Push the male camlock into the entry hole.

2

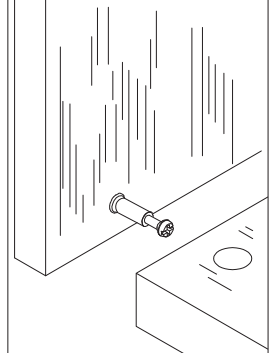

Step 3

Insert the female camlock as shown in the instruction.

Note: ensure that the arrow on the top of the camlock points towards the entry hole for the male camlock.

3

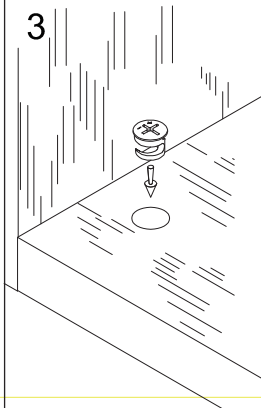

Step 4

Turn the female camlock clockwise with a screwdriver.

You should feel a click when the camlock is locked in place.

The joint is now secure.

4

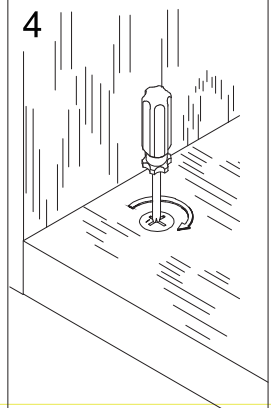

WARNING



Children have died from furniture tipover. To reduce the risk of furniture tipover:

- ALWAYS install tipover restraint provided.
- NEVER put a TV on this product.
- NEVER allow children to stand, climb or hang on drawers, doors, or shelves.
- NEVER open more than one drawer at a time.
- Place heaviest items in the lowest drawers.



This is a permanent label.
Do not remove!

PRODUCT ASSEMBLY

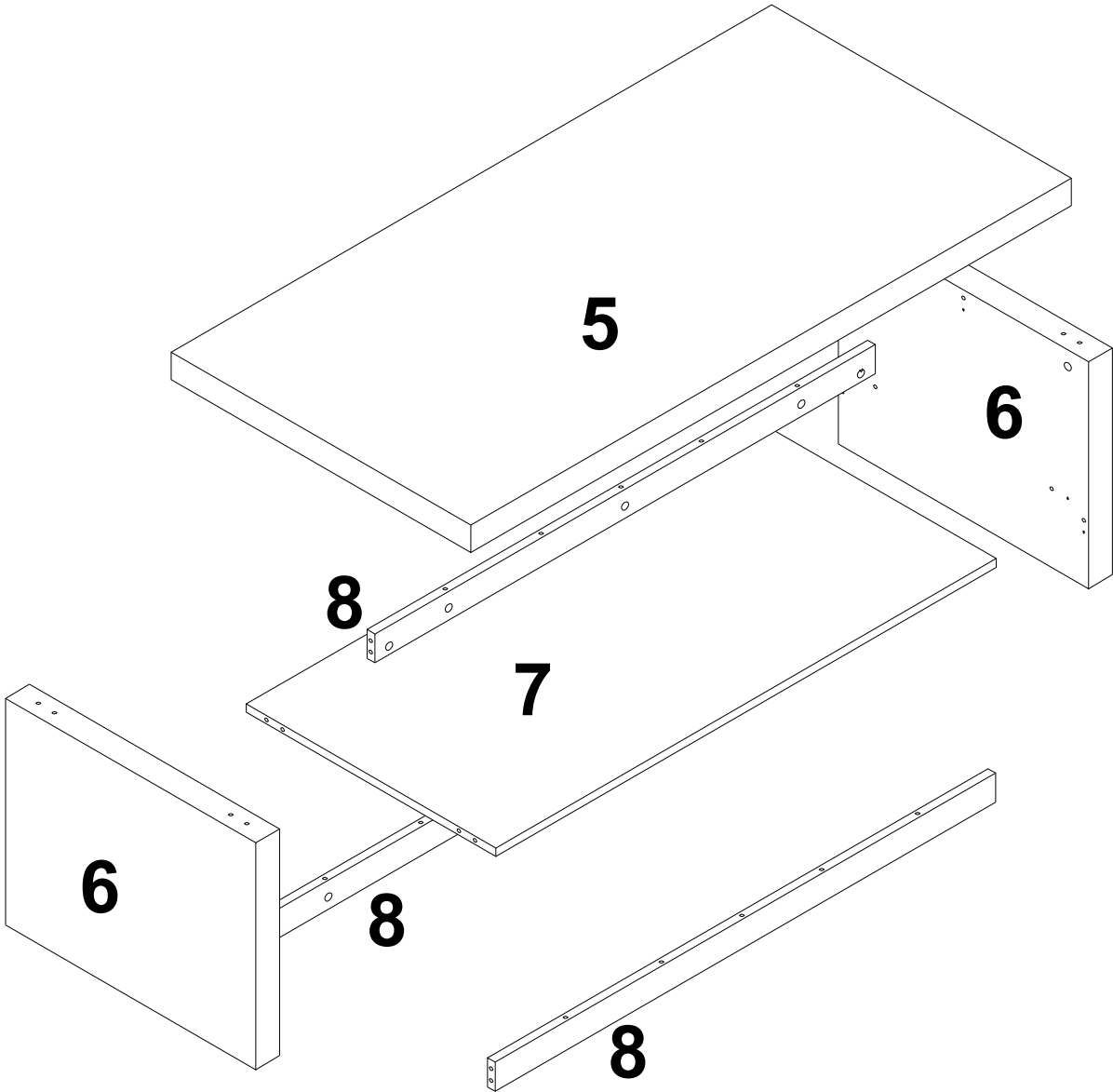

Components - Panels

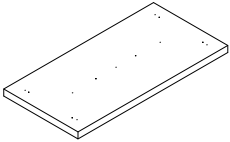
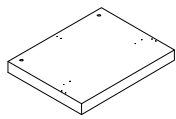
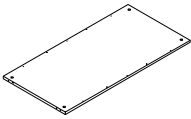
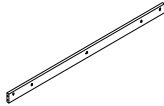

Please check you have all the panels listed below

<p>⑤</p>  <p>1 PC</p>	<p>⑥</p>  <p>2 PCS</p>	<p>⑦</p>  <p>1 PC</p>	<p>⑧</p>  <p>3 PCS</p>
--	---	--	---

Components - Fittings

Please check you have all the panels listed below

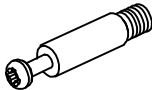
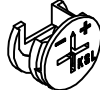
Note: The quantities below are the correct amount to complete the assembly, in some cases more fittings may be supplied than are required.

A		23pcs +2 pcs	B		23pcs +2 pcs
C	 Ø8*30MM	20pcs +2 pcs	D	 Ø20MM	9pcs +2 pcs

PRODUCT ASSEMBLY

A		7pcs
---	---	------

Step 1

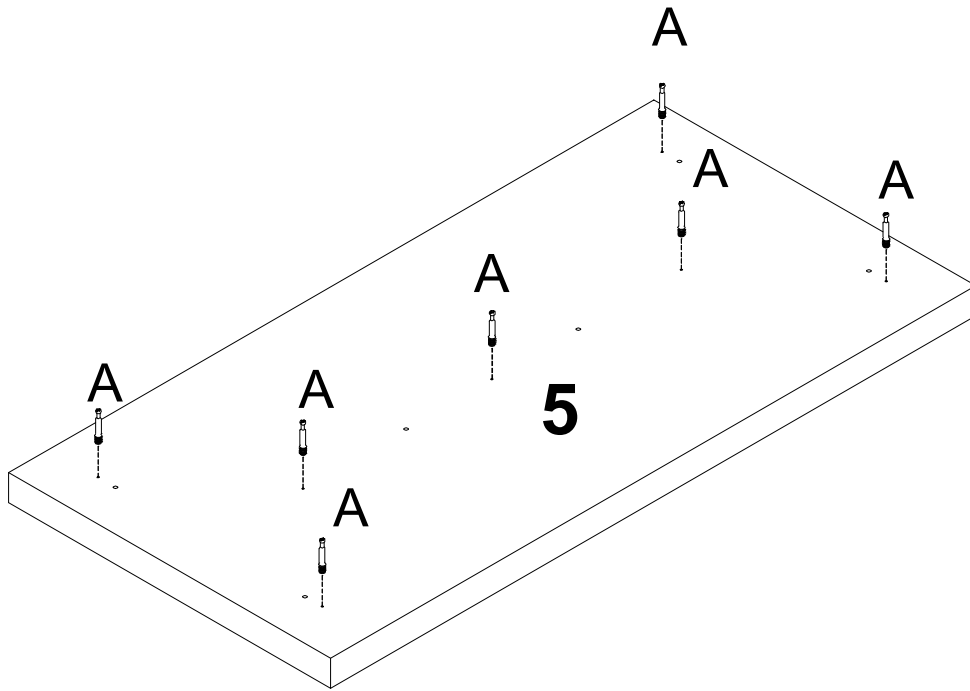

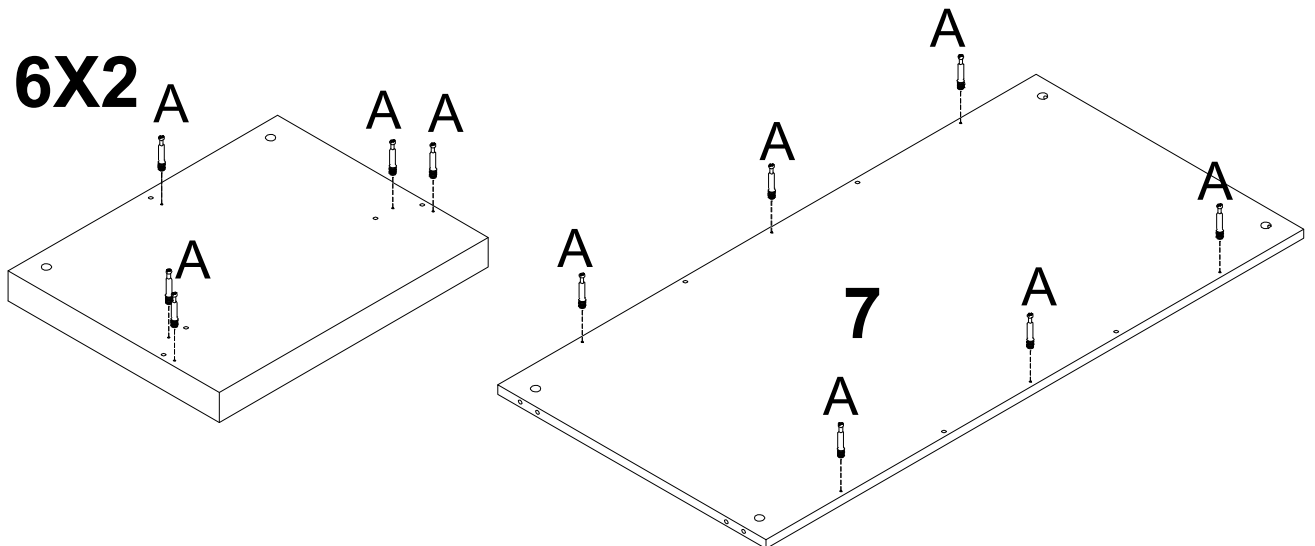

A		16pcs
---	---	-------

Step 2





PRODUCT ASSEMBLY

Step 3

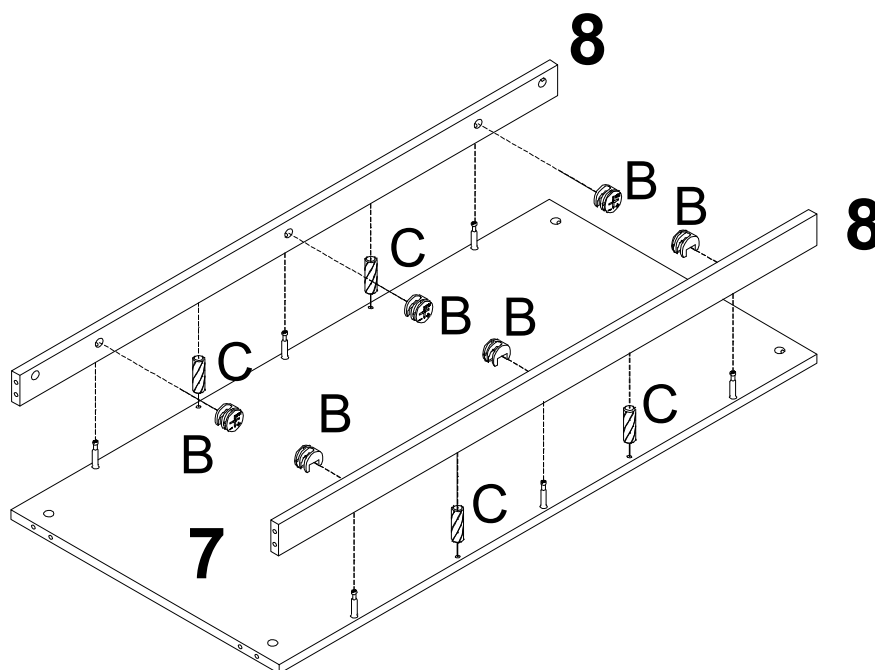
B		6pcs
C		4pcs



Step 4

B		4pcs
C		4pcs

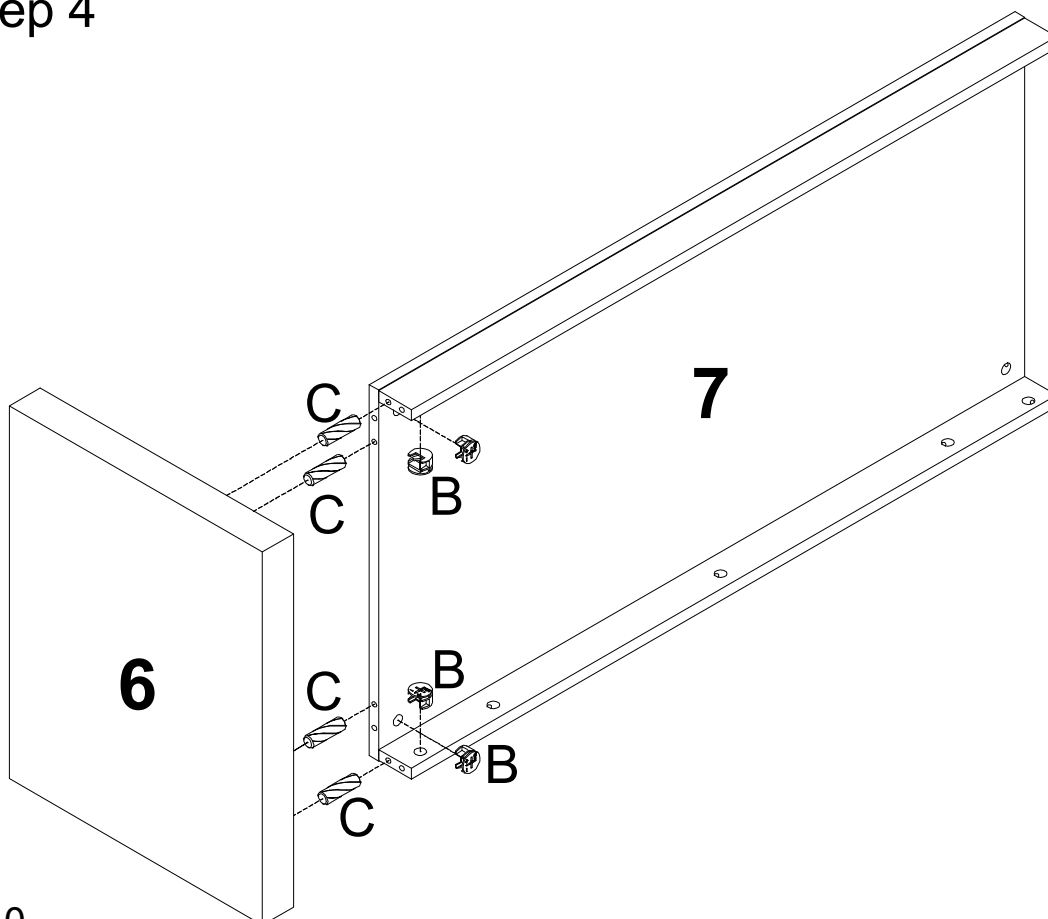

PRODUCT ASSEMBLY



Step 5

When assembling the No. 8 board, please hold it firmly by hand.
The components are fragile and prone to damage.
Operating it gently will make the process safer.

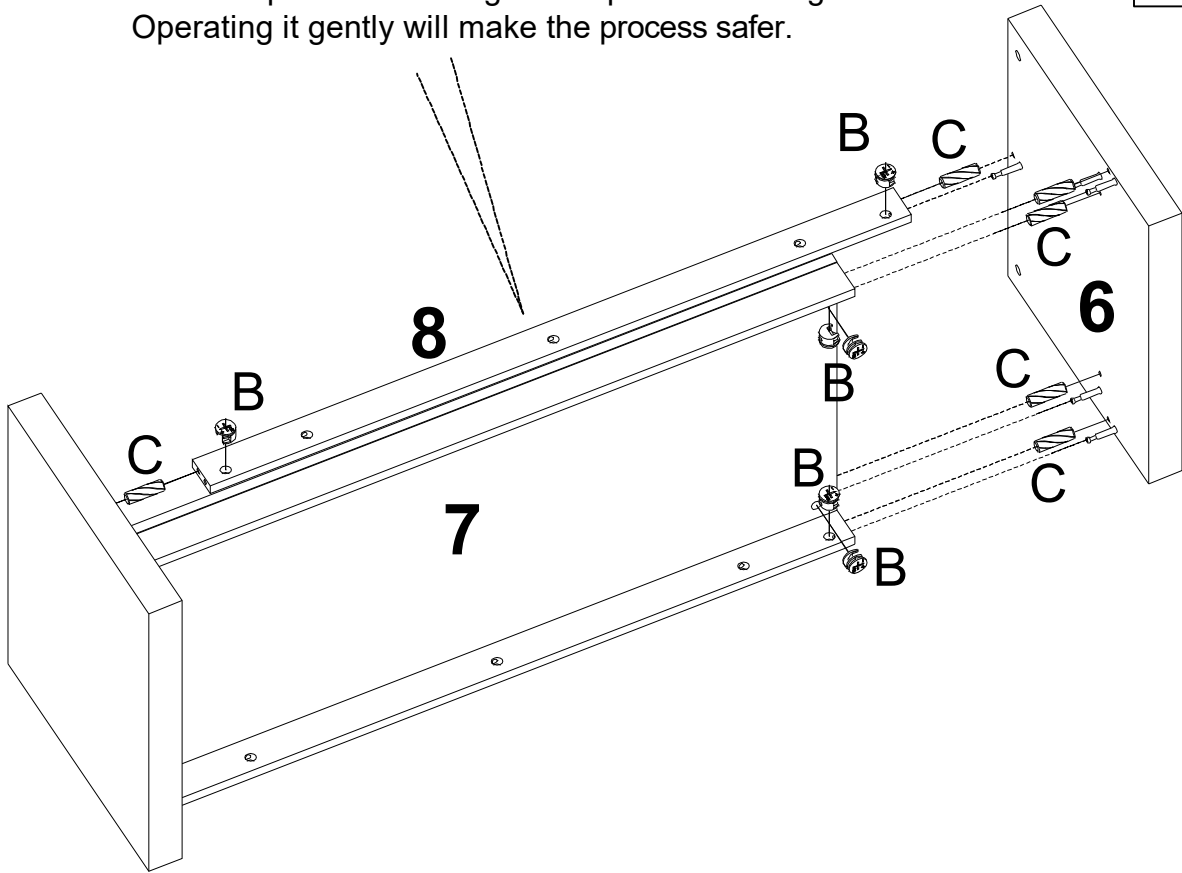
B		6pcs
C		6pcs



Step 6

B		7pcs
C		6pcs

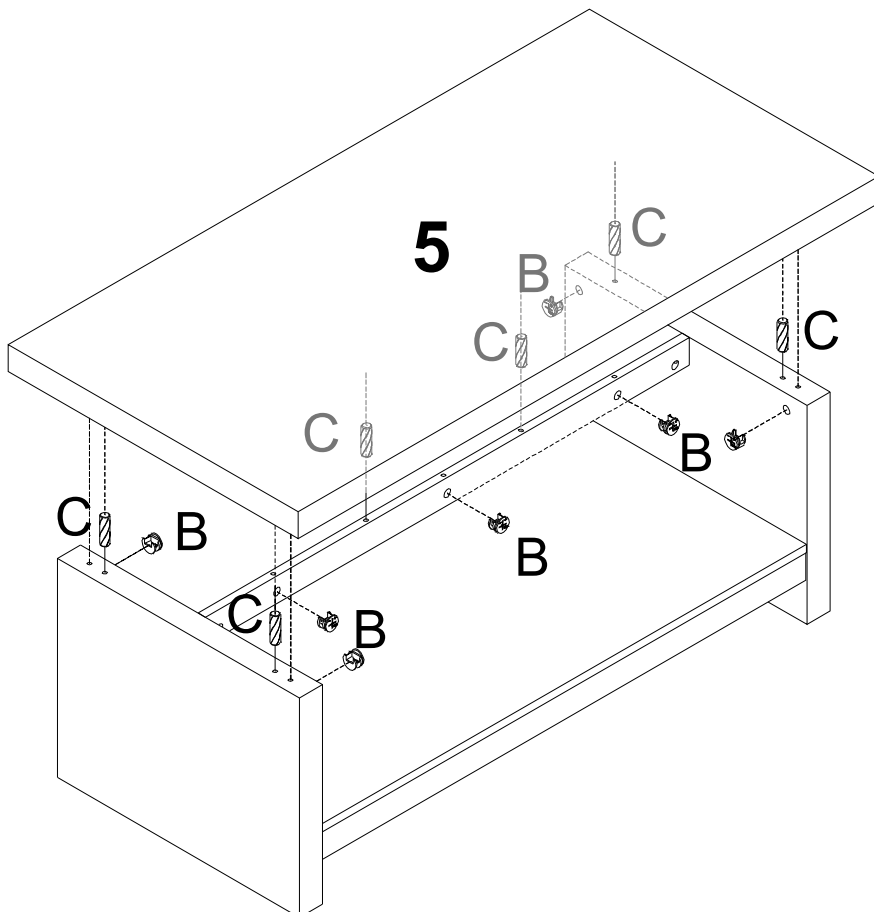

PRODUCT ASSEMBLY

D		9pcs
---	---	------

Step 7

