











Assembly Instructions

Caution : You must read this before you proceed

Care & Maintenance

-  ● Not for commercial use. For residential use only.
-  ● Furniture may scratch floors. We recommend using furniture pads to protect your floors.
-  ● Do not put hot items directly on furniture surface.
-  ● Do not clean furniture with harsh cleansers or polish.
-  ● Do not place furniture under direct sunlight.
-  ● Do not place furniture near heating or cooling vents.
-  ● Do not write on furniture without a padded barrier to protect the surface.
-  ● Do not place furniture outside . For indoor use only.
-  ● Stains may be removed with mild soap solution and damp cloth.
-  ● Children should not climb or jump on the furniture.
-  ● Dust and pick-up spills using a clean, non-colored, lint-free cloth.



Please look in carton for hardware packs and legs.

Sets often ship in multiple boxes and may arrive a day or two apart.





Chair



Parts List

Label	Picture	Description	QTY
A		Chair Seat	1
B		Chair Base	1

Hardware

Label	Picture	Description	QTY
①		Flat Washers (ϕ 6mm)	5
②		Spring Washers (ϕ 6mm)	5
③		Screws (M6x20mm)	5
④		Allen Wrench	1

Assembly Preparation

Before Beginning Assembly:



- Read instructions, cover to cover-



- Have 2 adults on hand for assembly-



- Do not assemble on flooring or carpet-



- Assemble on a clean non-marring surface (packing foam)-



- Save all packaging until finished-

Assembly Steps

Overview

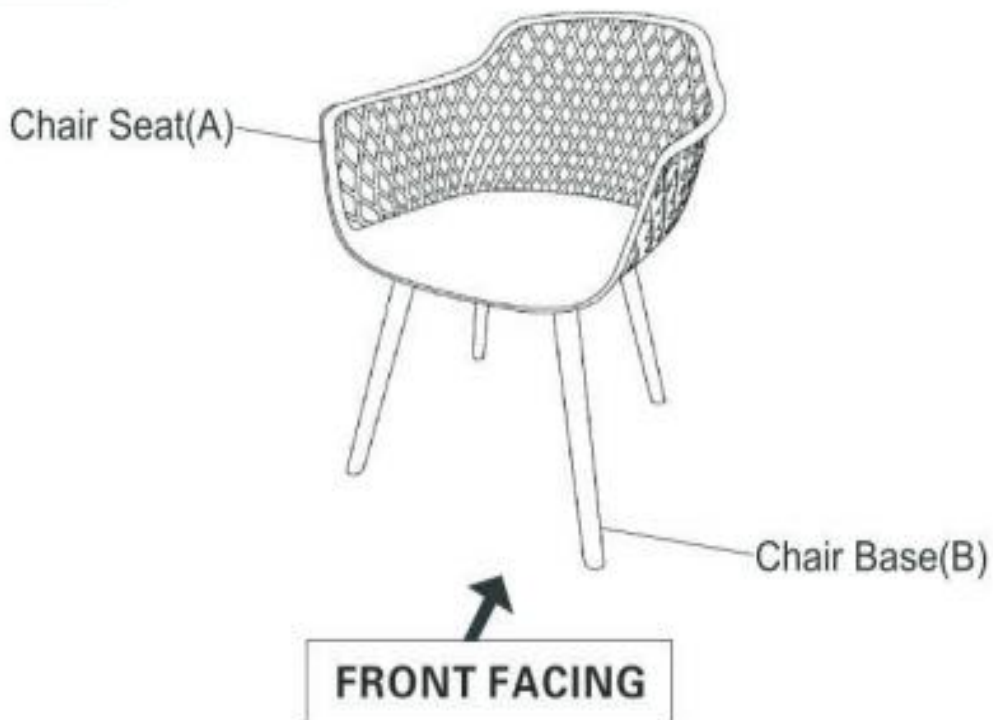

This Chair has multiple parts and may require up to 30 minutes to assemble. To give you an overview of the Chair parts, the above picture is to help you put the various parts into perspective. Please read through the instructions below to familiarise yourself with the parts and steps before assembly.

Step 1



Unpack and place all parts on a clean, non-marring surface.

Step 2

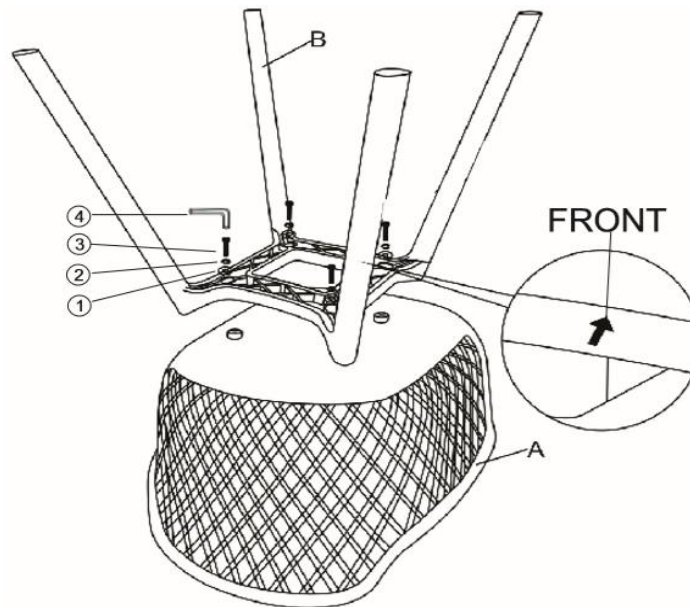

Place the Chair Seat (A) with its bottom side facing upwards onto a clean soft surface to avoid any scratches or damage to the product. Align the Mounting Position of the Chair Seat (A) with the Mounting Position of the Chair Base (B) as shown above. Then, affix the Chair Seat (A) to the Chair Base (B) using Flat Washers (①), Spring Washers (②), Screws (③) and the Allen Wrench (④) DO NOT FULLY TIGHTEN THE SCREWS AT THIS TIME.

Step 3



Turn the Chair up. Place the Chair on a LEVEL SURFACE. Inspect it and make sure all parts are adequately connected. Gently and carefully, sit into the Chair. This will help align all the parts at all the joint areas. Then get off the Chair, and in a sequential manner, proceed to tighten all screws. Please turn each screw 6 times, so they are neither too loose nor too tight. To tighten the Screws, do secure assistance from your adult partner(s). You may be required to turn the Chair, to gain easy access to the secure points. Turn the Chair in a synchronised manner.

CAUTION 1: When tightening these screws, tighten sequentially. DO NOT tighten any screw fully and then move towards the next one. This would cause the frame to warp. If the chair wobbles after tightening, loosen the screws and execute this same process. WARNING!! IF the Chair IS NOT STABLE, IT COULD LEAD TO DAMAGING THE PRODUCT. Ensure all screws are fully locked into position. The Chair is ready to be used. Caution 2: This Chair can only be used on a flat, level surface.

Questions & Answers about Proposition 65

• What is Proposition 65?

Proposition 65 requires businesses to provide warnings to Californians about significant exposures to chemicals that cause cancer, birth defects or other reproductive harm. These chemicals can be in the products that Californians purchase, in their homes or workplaces, or that are released into the environment. By requiring that this information be provided, Proposition 65 enables Californians to make informed decisions about their exposures to these chemicals.

Proposition 65 also prohibits California businesses from knowingly discharging significant amounts of listed chemicals into sources of drinking

water.

Proposition 65 requires California to publish a list of chemicals known to cause cancer, birth defects or other reproductive harm. This list, which must be updated at least once a year, has grown to include approximately 900 chemicals since it was first published in 1987.

- What types of chemicals are on the Proposition 65 list?

The list contains a wide range of naturally occurring and synthetic chemicals that include additives or ingredients in pesticides, common household products, food, drugs, dyes, or solvents. Listed chemicals may also be used in manufacturing and construction, or they may be byproducts of chemical processes, such as motor vehicle exhaust.

- What does a warning mean?

If a warning is placed on a product label or posted or distributed at a workplace, a business, or in rental housing, the business issuing the warning is aware or believes that it is exposing individuals to one or more listed chemicals.

By law, a warning must be given for listed chemicals unless the exposure is low enough to pose no significant risk of cancer or is significantly below levels observed to cause birth defects or other reproductive harm.

- Where can I get more information on Proposition 65?

If you have specific questions on the administration or implementation of Proposition 65, you can contact OEHHA's Proposition 65 program at P65.Questions@oehha.ca.gov, or by phone at (916) 445-6900.

