

# ASSEMBLY INSTRUCTION

Thank You for purchasing this Quality product. It has been engineered for easy assembly yet constructed for durability. Please take the time to read and follow the instructions while assembling.

42" L x 22"D x (1-10"Leaf ) x 37" HT

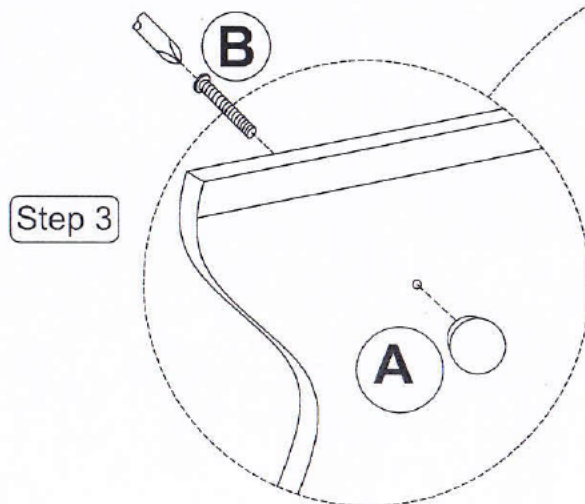
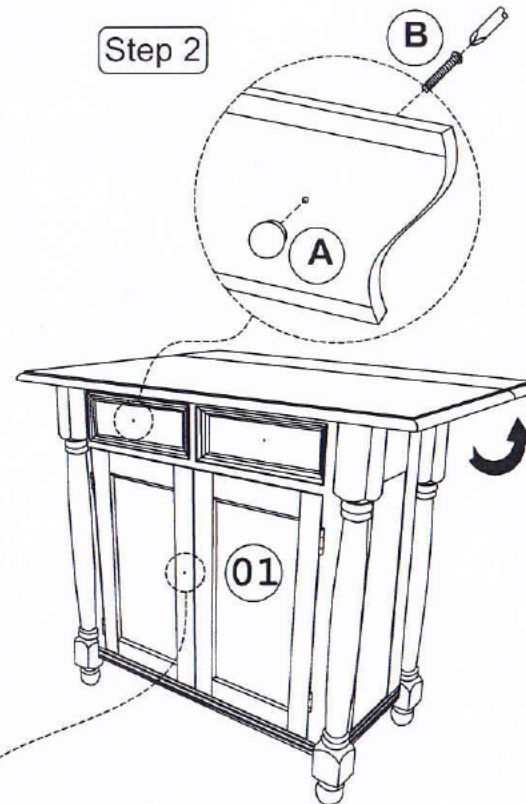
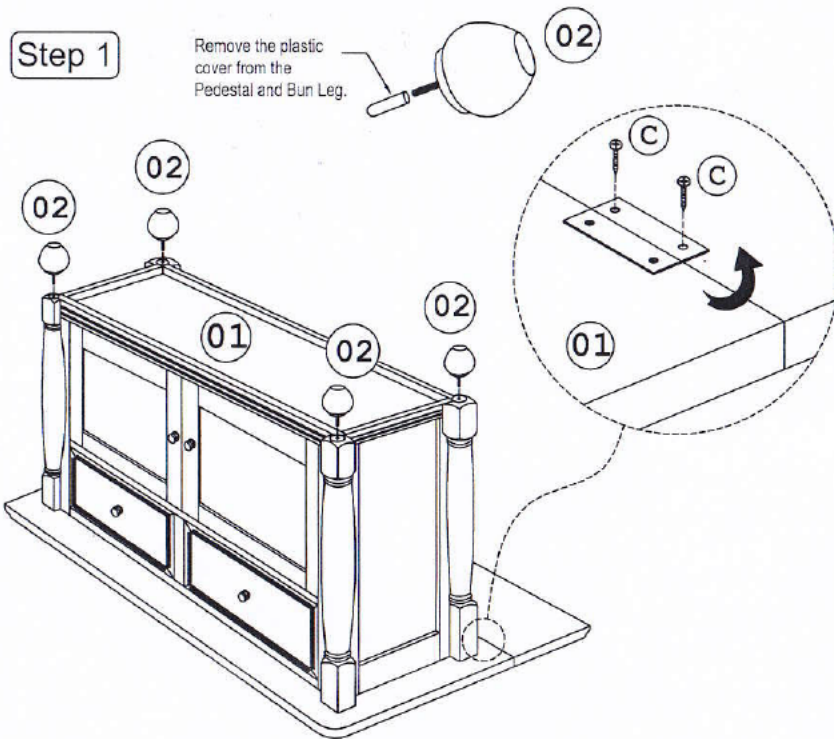

## LIST OF PARTS FOR 1 SET

01		CABINET	1
02		BUN LEG	4

## LIST OF HARDWARE FOR 1 SET

A		WOOD HANDLE	4
B		THMS SCREW 5/32" x 25mm	4
C		CSK CB SCREW M3.5 x 16mm	6

## ! Important Notes

- \* Keep all hardware parts out of reach of children.
- \* Must tighten screws periodically. With use screws will become loose. Check tightness of all screws every 6-8 weeks.
- \* Don't attempt to repair or modify parts that are broken or defective. Please contact the store immediately.
- \* Do not tighten all screws / bolts until all completely assembled.

# Swivel Barstool Assembly

## Before you begin:

- Check to be sure that you have all parts and hardware
- Place all wooden pieces on a clean and smooth surface like a carpet to avoid parts being scratched
- Do not tighten all screws/ bolts until completely assembled
- Swivel plate top and bottom needs to be turned at 90-degree angles prior to installation. If not pre-turned, place swivel plates on your floor, use packaging carton to protect the surface, step on swivel to twist using your body weight











**Step 1.** Place swivel on base with 'TOP FRONT' markings on swivel facing upward. Attach swivel to base using four (4) #10 Philips screws and four (4) flat washers. Tighten with a #10 Philips screwdriver (Not Provided).

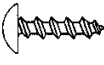

**Step 2.** Place seat upside down on table or bench (lay a towel down to protect from scratches) or on the edge of mattress.

**\*IMPORTANT:** Make note of marking on top of swivel that reads 'TOP FRONT'. This side of the swivel must be mounted toward the front of the barstool seat in order to provide proper angle for sitting.

Parts		QTY
Top Seat Unit (Pre-Assembled)		1
Base (Pre-Assembled)		1
Swivel Plate		1
Seat Machine Bolts		4
Lock Washers		4
Flat Washers		8
#10 Philips Screws		4
4mm Allen Wrench		1

Flip base upside down and place on top of Seat Unit bottom. Line up the four (4) slots in the swivel top with the four (4) nut inserts that are mounted in the seat.

**Step 3.** Put one (1) Lock Washer and one (1) Flat Washer on each Seat Machine Bolt. Attach the swivel to the seat bottom through the access hole in the bottom of the base Unit with all four (4) bolts.

**Step 4.** Screw all 4 bolts in half way with Allen wrench provided. Turning base unit as needed to access the nuts that are inserted on the barstool seat. Tighten all bolts fully when done. Assembly is complete!

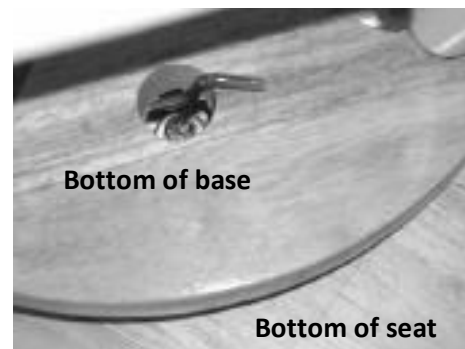

*Sunset Trading is happy to answer any assembly questions and replace missing parts. We appreciate your business and our main concern is your convenience and happiness. Thank you for your purchase and we look forward to serving you as our lifelong customer! We hope you enjoy your new stools! The Sunset Trading Team*