

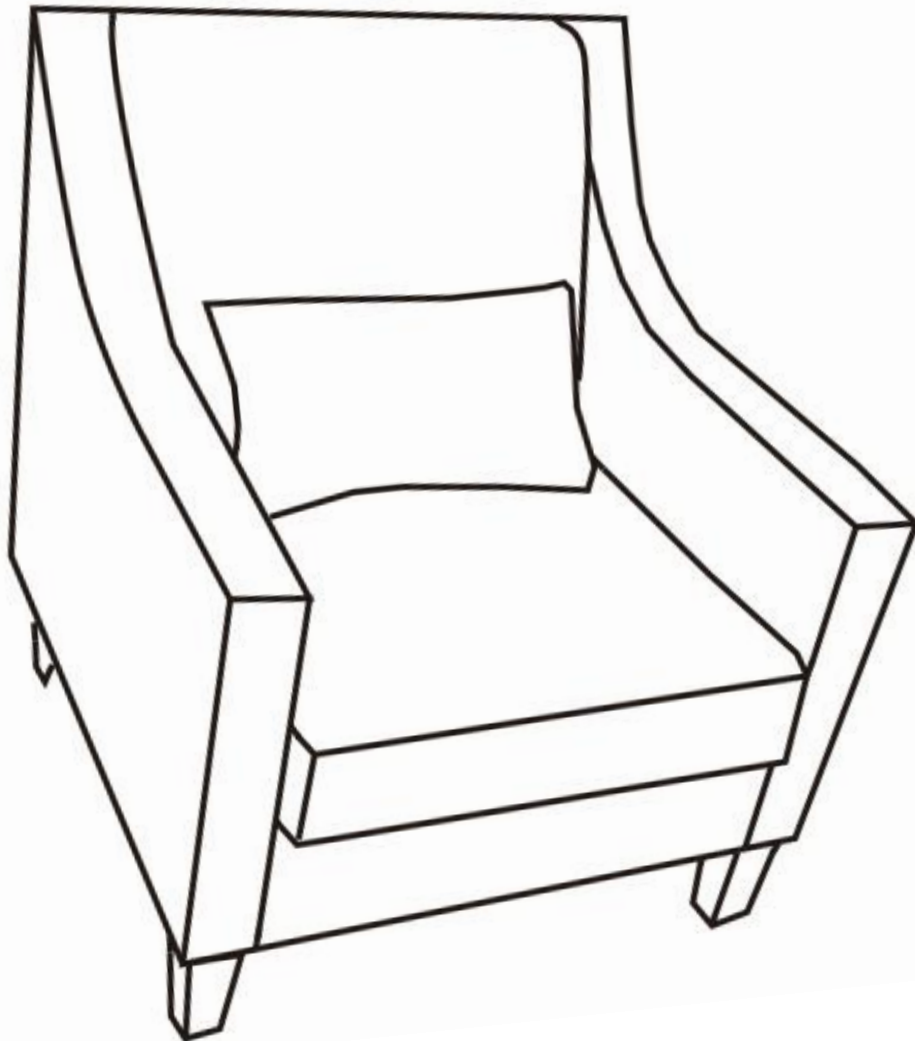





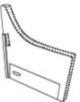

ASSEMBLY INSTRUCTIONS

ACCENT CHAIR

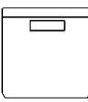

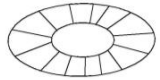
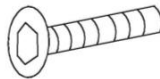
PARTS LIST		
LABEL	PICTURE	QTY
A		4
B		2
C		1
D		1
E		1
F		1
HARDWARE		
LABEL	PICTURE	QTY
G		1
H		4
I		2
J		2
K		2

Step 1

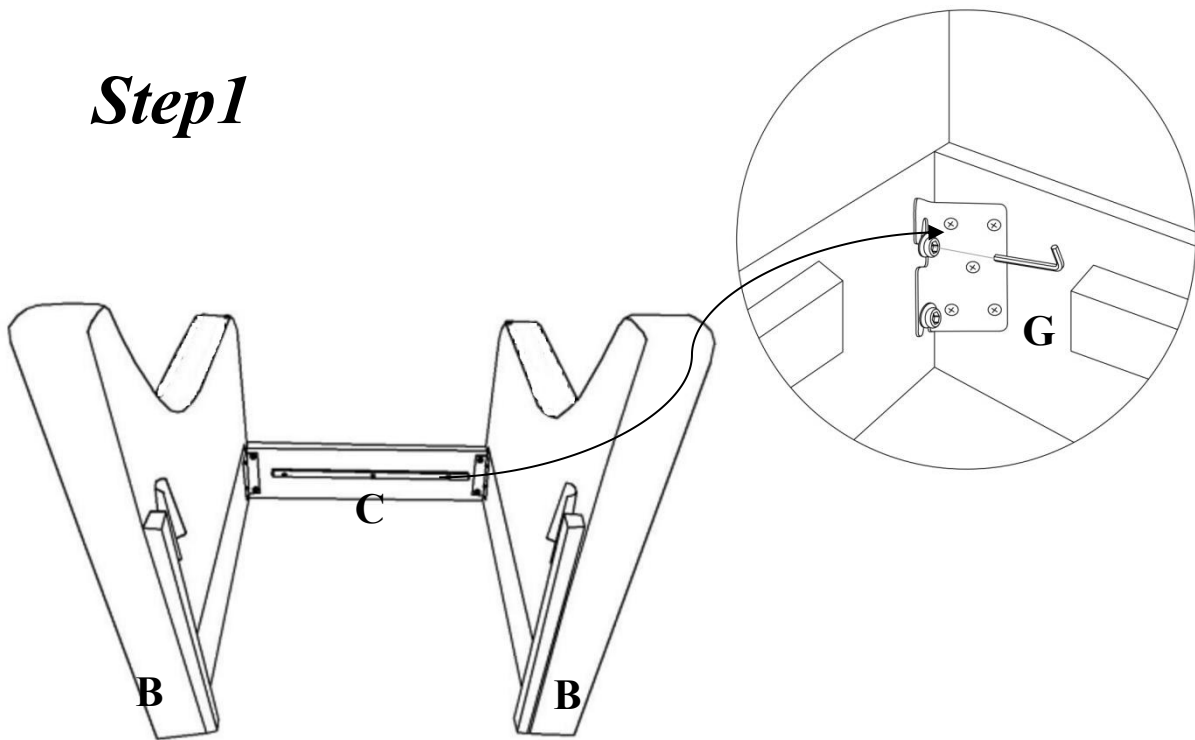

Tip: Once the iron plates onto the screws, tighten all screws securely

Step 2

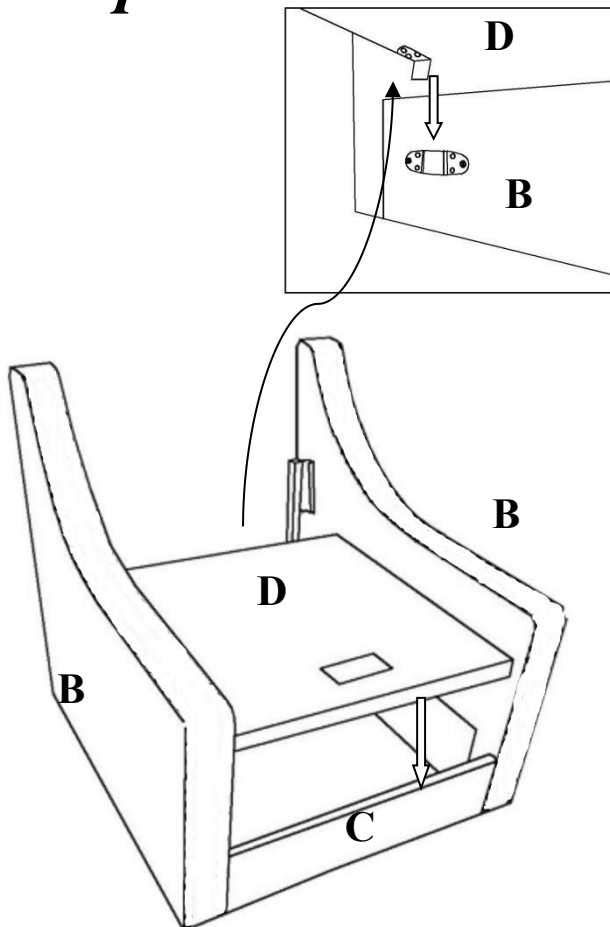

Step 3

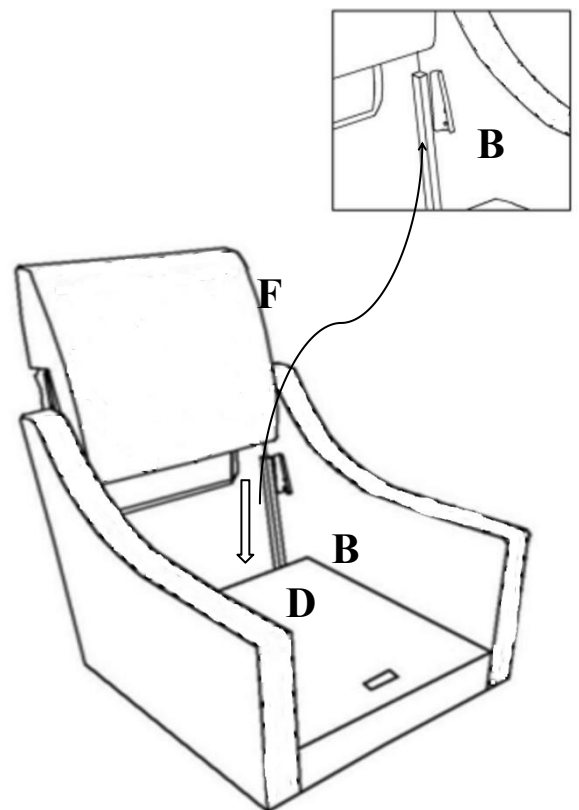

Step4

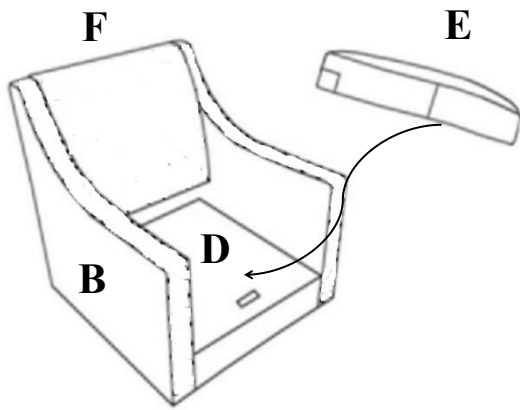

Step5

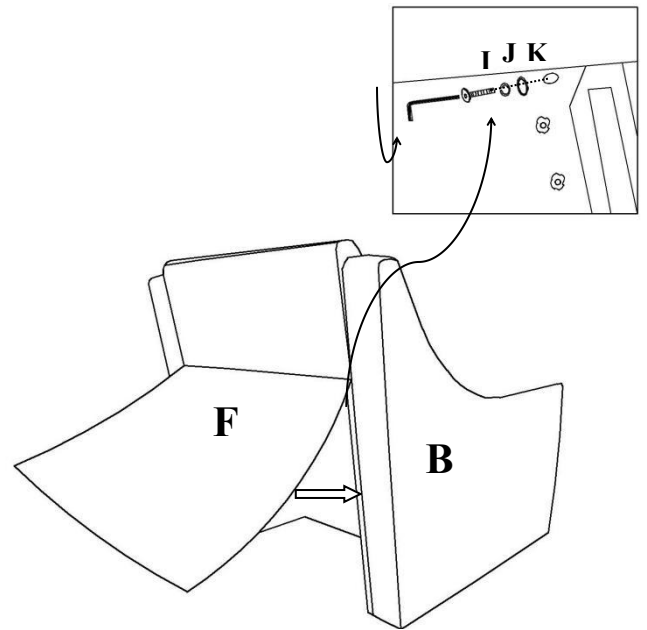

Tip: Once the iron plates onto the screws, tighten all screws securely

Step6

