

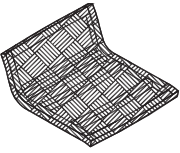

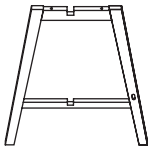







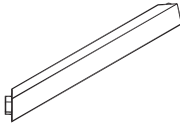

<p>Ax1</p> 	<p>Bx1</p> 	<p>Cx1</p> 	<p>Dx1</p> 
<p>Ex1</p> 	<p>Fx1</p> 	<p>Gx1</p> 	<p>① x2</p>  <p>M4</p>
<p>② x2</p>  <p>25x $\frac{33}{1.3}$</p>	<p>③ x2</p>  <p>M7x $\frac{35}{1.4}$</p>	<p>④ x4</p>  <p>M7x $\frac{70}{2.8}$</p>	<p>⑤ x16</p>  <p>M4x $\frac{15}{0.6}$</p>
<p>⑥ x1</p>  <p>20x $\frac{160}{6.3}$</p>	<p>⑦ x4</p>  <p>M6x $\frac{60}{2.4}$</p>	<p>⑧ x4</p>  <p>M6x $\frac{16}{0.6}$ x $\frac{1}{0.04}$</p>	 <p>mm inch</p> <p>x1</p>



2

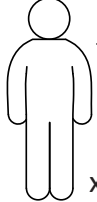
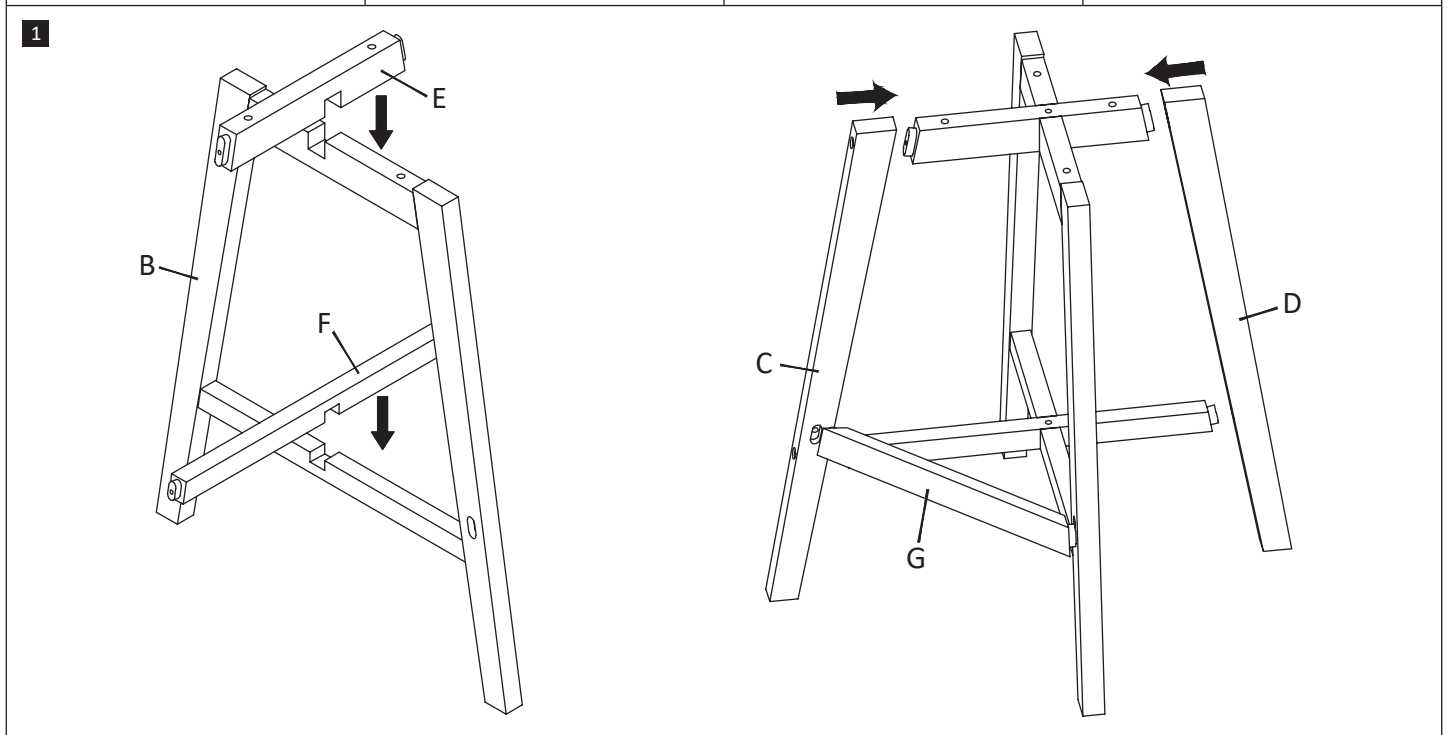
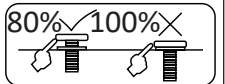
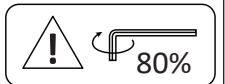
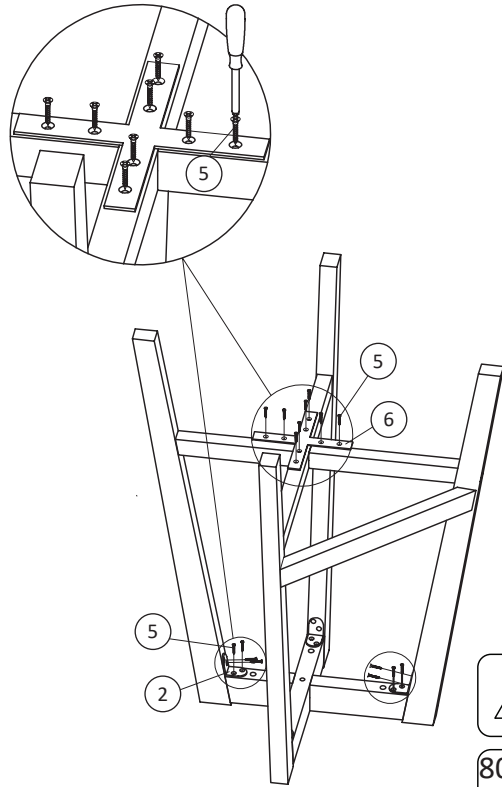
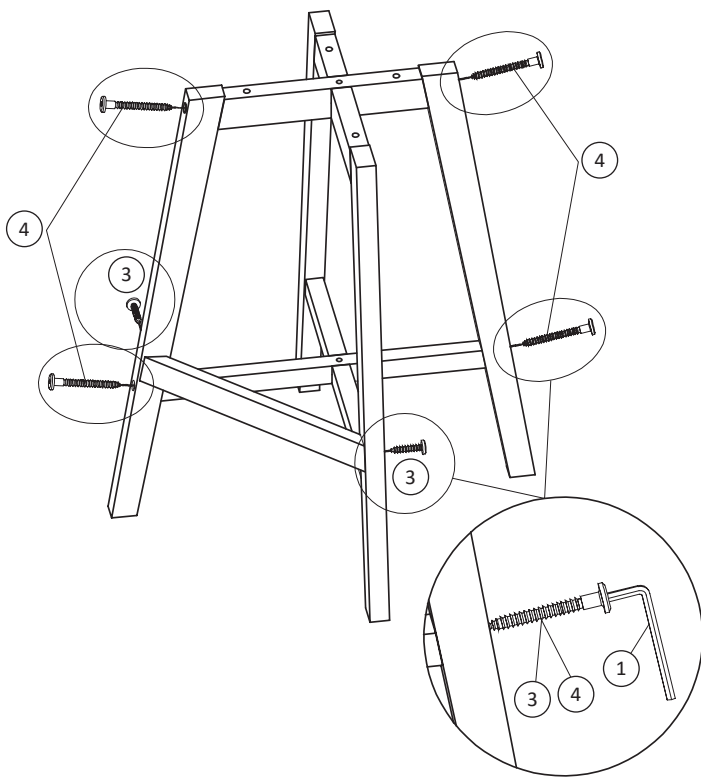

3

