

MODEL RTA-TSF72

ASSEMBLY INSTRUCTIONS





REV.2-WT-A9542-0426

Thank you for purchasing our product!

Scan QR to
view full
assembly
VIDEO

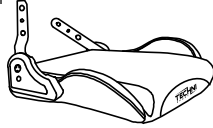
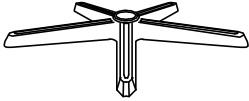
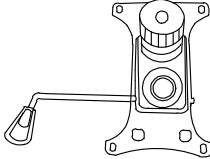

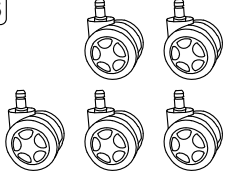
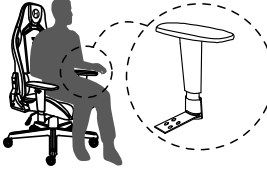
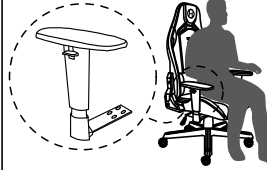
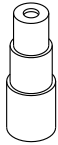

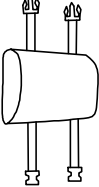



MAIN PARTS LIST

<p>A Backrest</p> 	<p>B Seat</p>  <p>* Read below about the right bracket</p>	<p>C Nylon star base</p> 
<p>D Mechanism</p> 	<p>E Lift cylinder</p> 	<p>F Casters</p> <p>x5</p> 
<p>G-L Left armrest</p> 	<p>G-R Right armrest</p> 	<p>H Covers for lift cylinder</p> <p>x1 Set</p> 
<p>I-L Left cover</p> 	<p>I-R Right cover</p> 	<p>J-L Lumbar pillow</p> 

* The left metal bracket on the seat is loose, while the right is stiff and can only move once the chair is assembled.

Hardware

No.	Item	Qty.	No.	Item	Qty.
L	 M8x20	4	P	 Ø17, Ø9 Washer	16
M	 M6x25	12	Q	 Ø25, Ø9 Felt washer	4
N	 M5x12	2	R	 Ø14, Ø11 Caps	4
O	 Ø12, Ø9 O-Ring	16			

Tools (Included)

Allen Wrench



For support with assembly questions & replacement parts please email us at:
support@technisportusa.com
Free shipping within **the 48 Contiguous United States.**



For international customers & **AK-HI-PR** orders, **the customer is responsible for shipping costs plus any International local taxes or duties.**



ASSEMBLY STEPS

STEP 1 Use L, O and P to assemble D to B.

⚠ PAY ATTENTION!

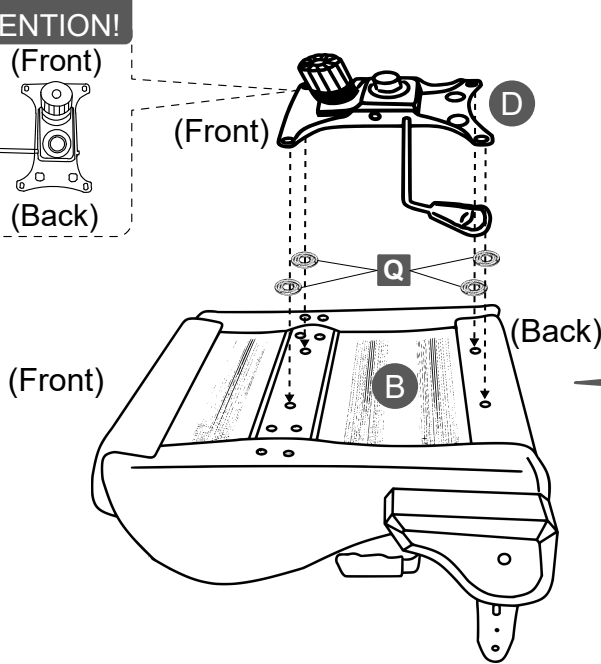
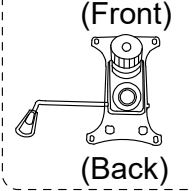

⚠ PAY ATTENTION:
O in the middle.

- L** (x4)
- O** (x4)
- P** (x4)

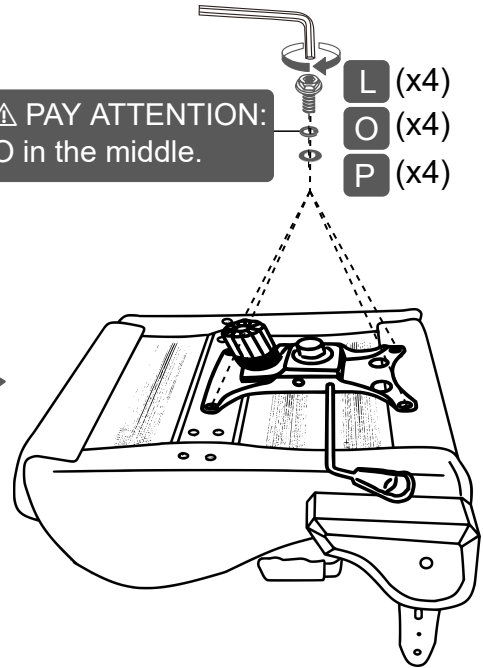

STEP 2
Use M, O and P to assemble G-L and G-R to B on their respective sides.

⚠ PAY ATTENTION:
O in the middle.

- M** (x8)
- O** (x8)
- P** (x8)

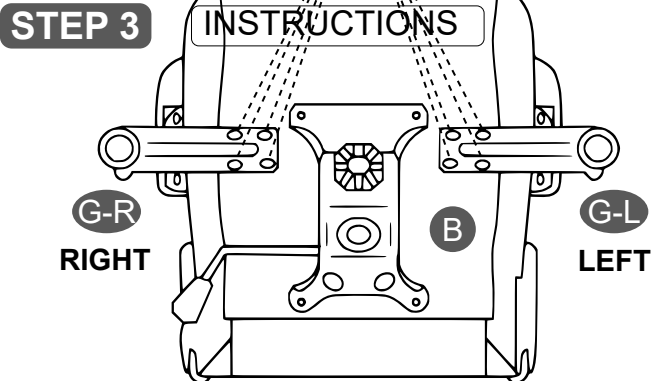

STEP 3
Attach F to C using force, E in the middle of C and cover it with H.

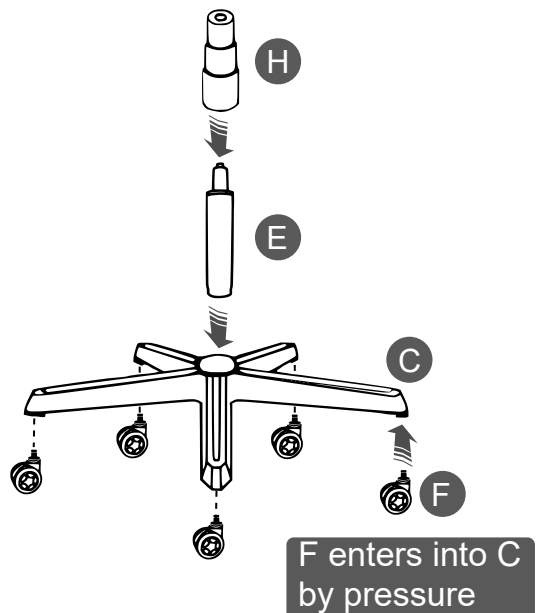

ASSEMBLY STEPS

STEP 4

Join The seat to The base.

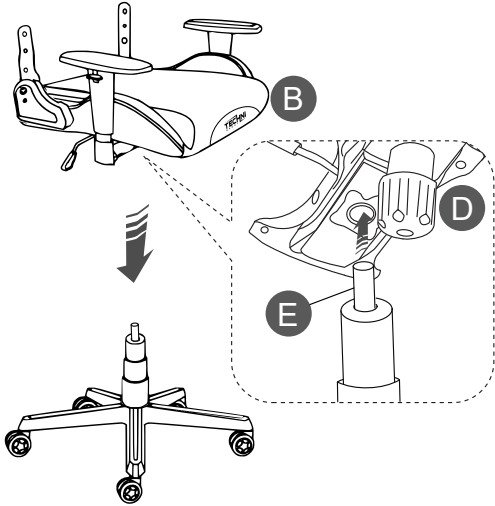

STEP 5

Use M, O and P to assemble A to B.



TIP! Screw loosely on each side first, tighten afterwards.

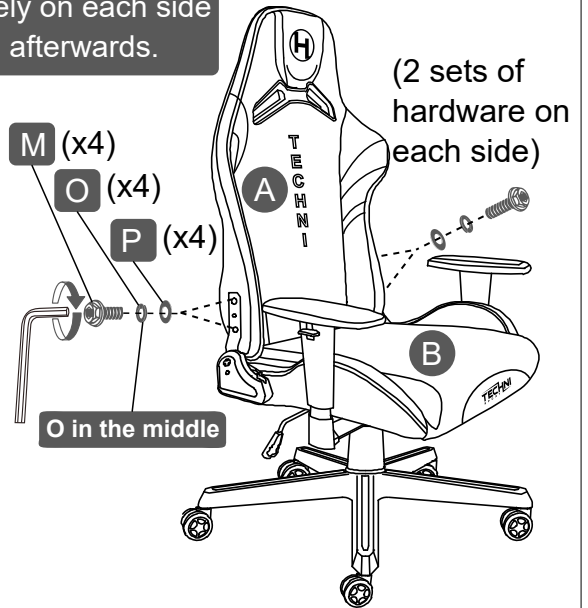
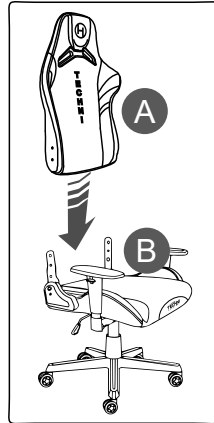

STEP 6

Use N to attach I-L and I-R to A on their respective sides, and cover the holes with R.

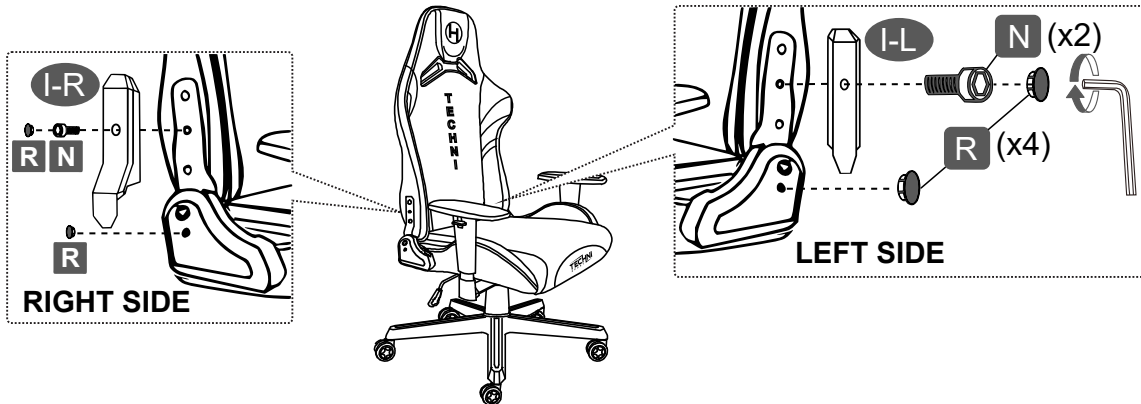

STEP 7

Attach J-L to A by fastening the buckles from behind.

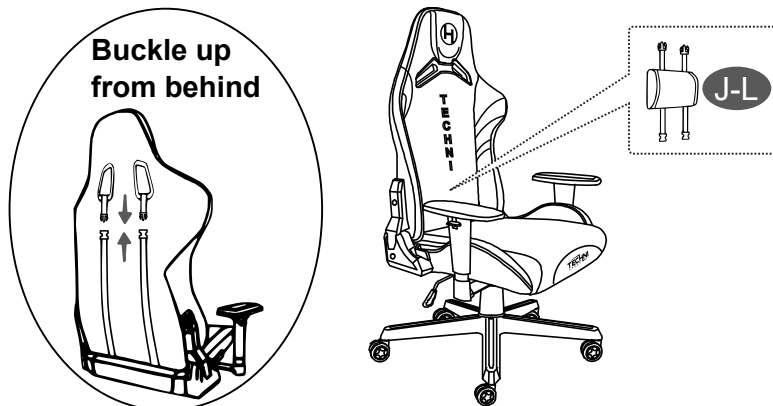

CHAIR'S FUNCTIONS

RECLINING * Read warnings below

Pull Handle UP and release once the desired angle has been reached.

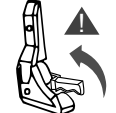

TILTING **

Pull Handle OUT to UNLOCK; Push Handle IN to LOCK.



HEIGHT

Pull Handle UP.

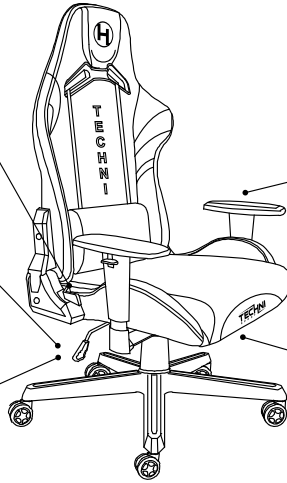

ARMRESTS

Press button and lift or lower the armrests.



TILT TENSION **

Clockwise = (+);
Counter-Clockwise: (-)

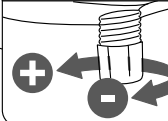

** Unlike regular office chairs, gaming chairs offer more resistance to tilting, even with the tension to the minimum (-). This is normal and should not be considered a manufacturing defect. Please contact us if you have questions.

WARNINGS - Not paying attention to the following warnings could result in injuries.

*VERY IMPORTANT:

Before reclining the backrest, make sure the tilt lever is PUSHED IN (locked).

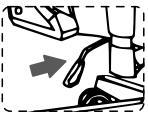

Weight Limit

250 Lbs
(113 Kg)

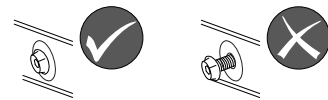

Do not use the chair if the frame parts are damaged, or if any of the screws are loose or missing.



Do not stand on the chair.



Only one person at a time and refrain from sitting on the edge of the seat to prevent the chair from tipping over.

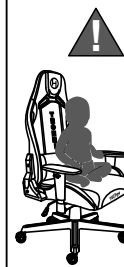

Do not leave babies or toddlers unattended while seated on the chair, always ensure adult supervision. Keep children from playing with the chair for their safety.

CARE AND MAINTENANCE

Clean with a soft cloth lightly dampened in a solution of smooth soap and water.

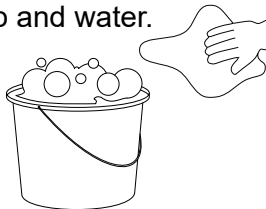

Do not use solvents or abrasive materials.



Do not expose to direct sunlight or to extreme environmental conditions.

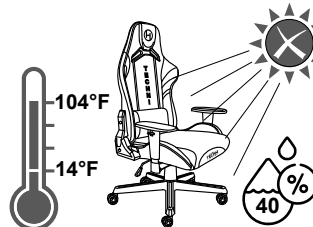

Inspect the unit thoroughly every 4 months and re-tighten the screws.

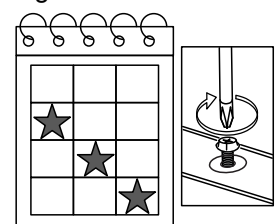

LIMITED WARRANTY

To file a claim or request information, please email to: warranty@rtaproducts.com

