

# Outdoor Glider

## Assembly Instructions

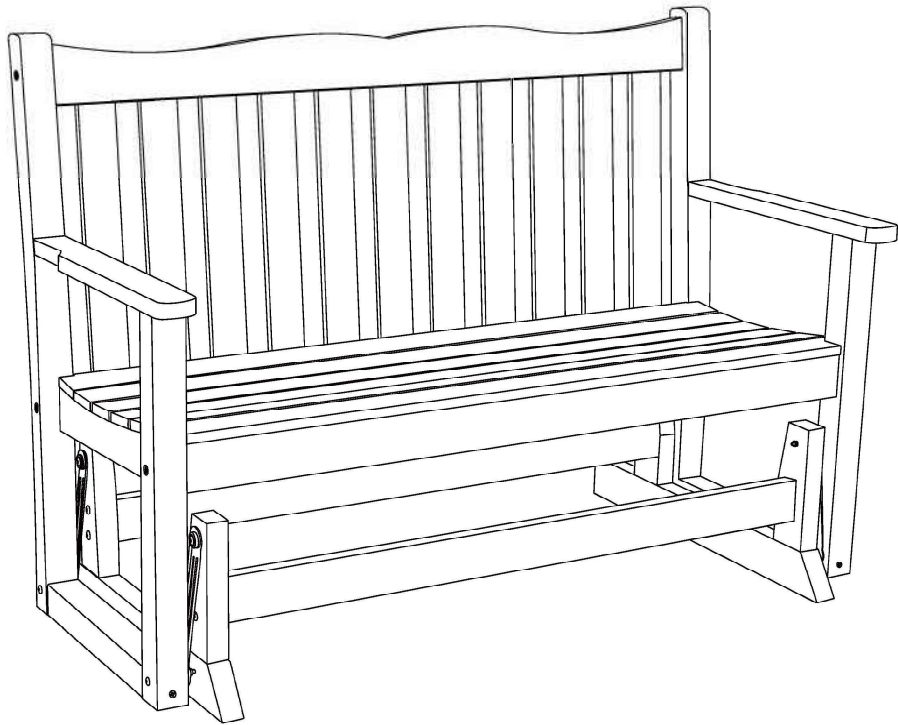

### Outdoor Furniture

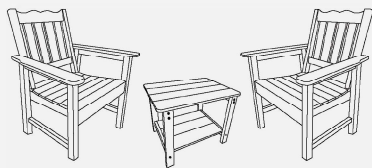

Patio Chairs+ Side Table Set

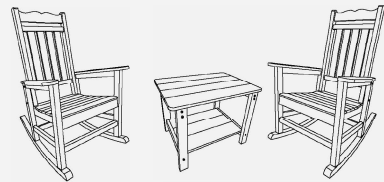

Rocking Chairs + Side Table Set

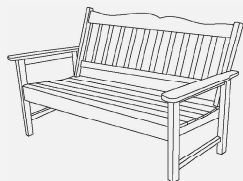

Outdoor Bench



Side Table

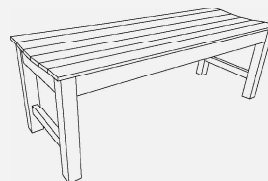

HIPS Dining Bench

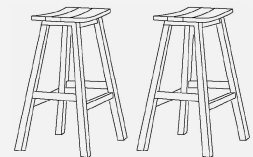

Patio Bar set

### Step 1

Attach Backrest to Seat Using Four "A" Bolts.

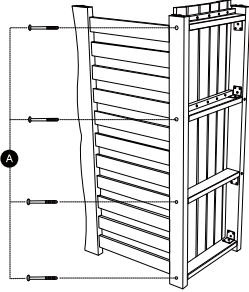

### Step 2

Attach right seat panel support frame to seat using three "B" Bolts.

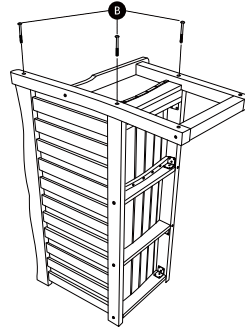

### Step 3

Attach left seat panel support frame to seat using three "B" Bolts.

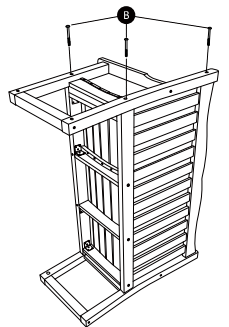

### Step 4

Assemble glider base

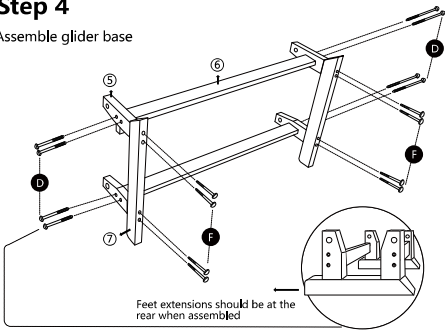

### Step 5

Assemble four glider bearing arms, and please place washers between glider bearing arms ⑧ and glider base legs ⑤.

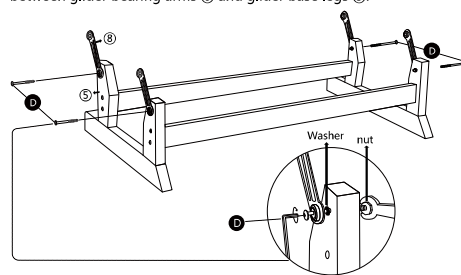





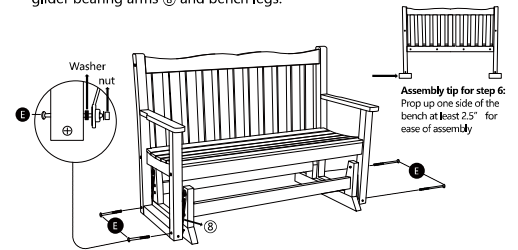





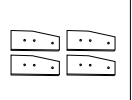
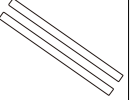

### Step 6

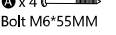
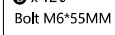
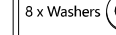
Attach the bench to the glider base, and please place washers between glider bearing arms ⑧ and bench legs.

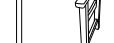

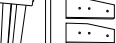
### Part list

 ① x 1PCS Seat panel	 ② x 1PCS Seat panel support frame (Right)	 ③ x 1PCS Seat panel support frame (Left)	 ④ x 1PCS Backrest	 ⑤ x 4PCS Glider base legs	 ⑥ x 2PCS Long slats	 ⑦ x 2PCS Glider base feet	 ⑧ x 4PCS Glider bearing arms	 ⑨ x 4 Bolt M6*55MM	 ⑩ x 12 Bolt M6*55MM	 8 x Washers
 ⑪ x 6 Bolt M8*65MM	 ⑫ x 4 Bolt M6*67MM	 ⑬ x 8 Bolt M6*85MM	 8 x Nuts	 1 x Spanner	 1 x Wrench					

★ Use on level ground only

★ Please keep away from extreme heat and strong oxidizing agents.

★ Under the sun, there is no need to cover the chair with an airtight dust cover, as the high temperature will deform the material.

★ Only need to wash with soap, water, soft bristle brush or sanding sponge.

★ Children should not climb or jump on the chair.