

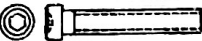

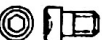

A		x1
B		x3
C		x3
D		x1
E		x1



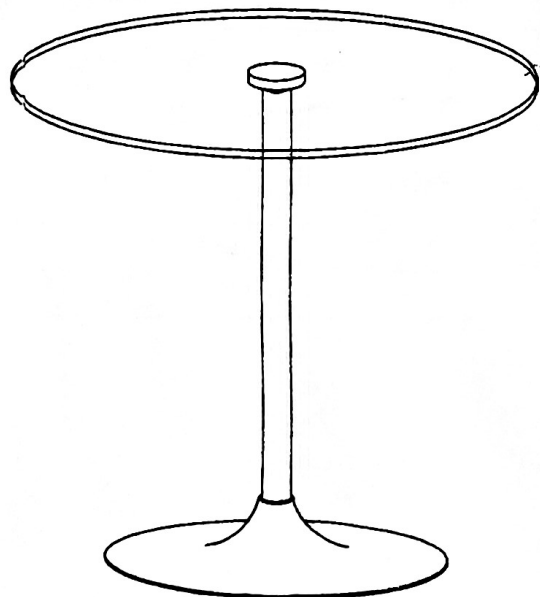

132-11

Finish

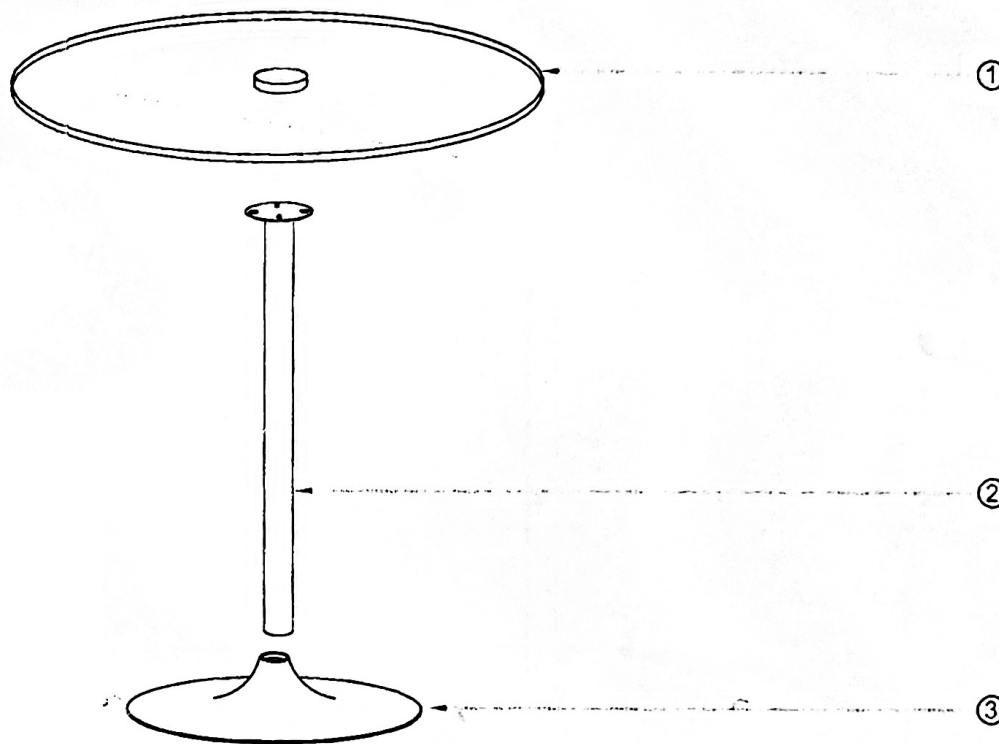

UDT317



 x2	 0:10	 °M5*1	 °M8*1
--	--	---	---

1

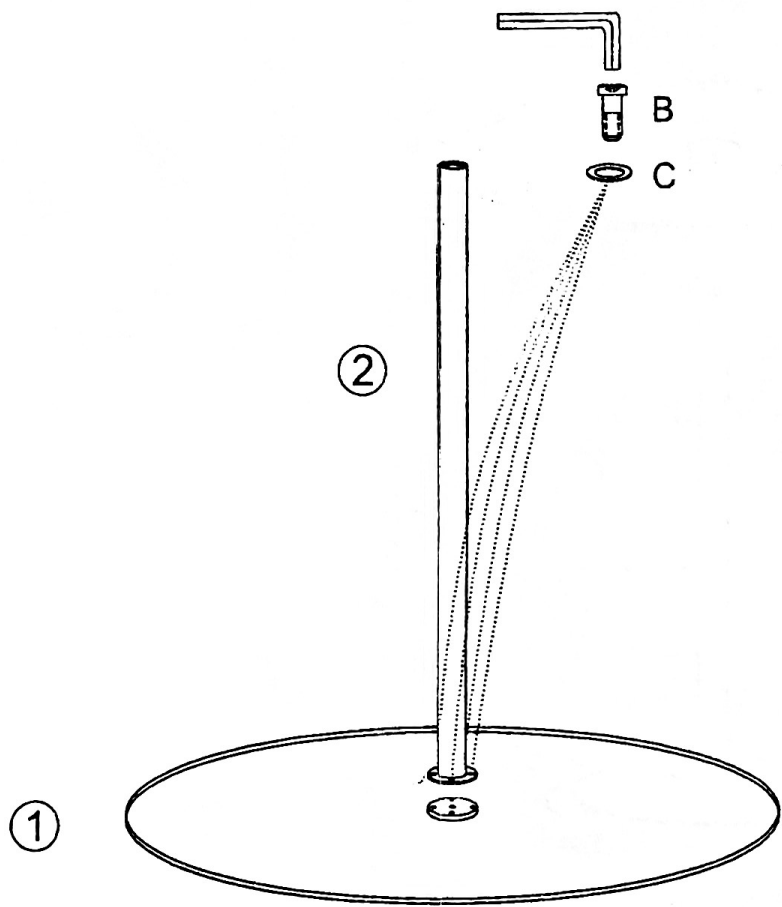

2

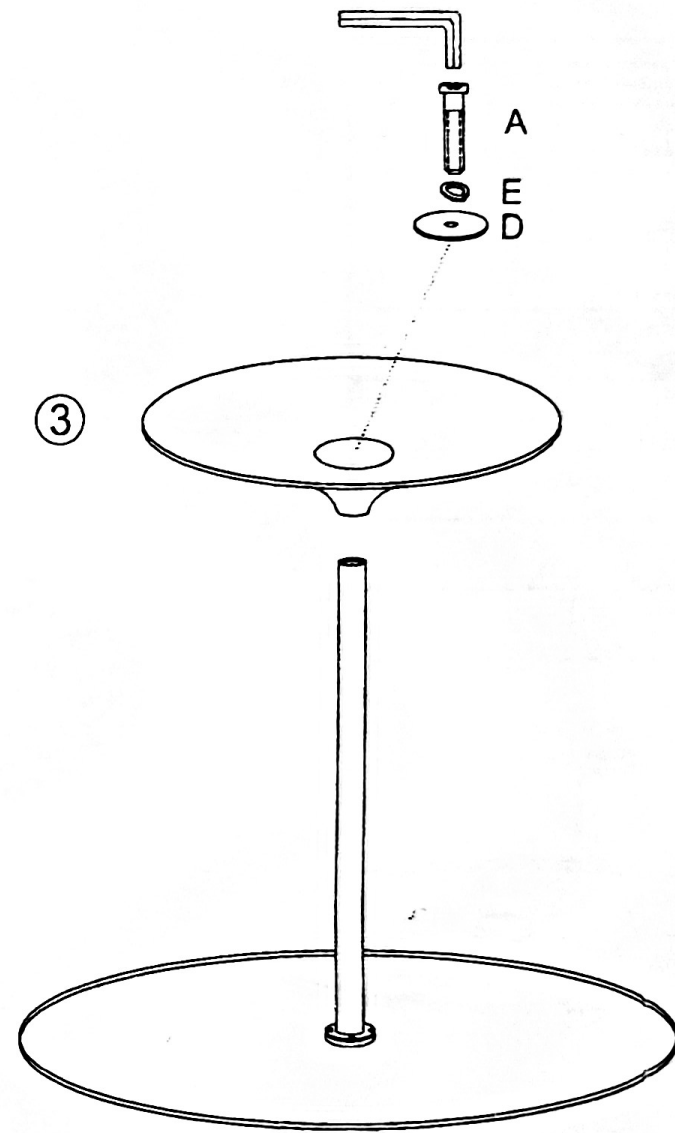

1

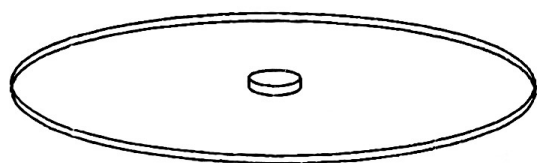

X1

2

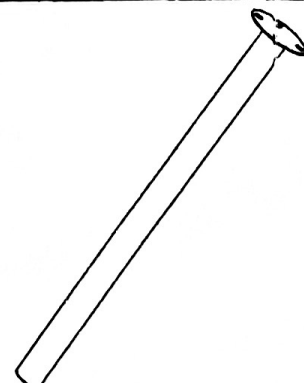

X1

3



X1