











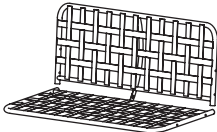



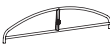





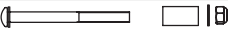
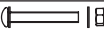

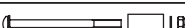
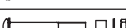
USER'S MANUAL

A		1
B		4
C		2
D		1
E		2
F		2
G		2
H		2
I		1
J		1

K		3
L		1
AA	 M8x100MM	4+1
BB	 M8x90MM	4+1
CC	 M8x50MM	2+1
DD	 M8x45MM	4+1
EE	 M6x85MM	4+1
FF	 M6x60MM	4+1
GG	 M6x40MM	8+1
HH	 M6x30MM	2+1
II		2
JJ		2
KK		2
LL		1
MM		1



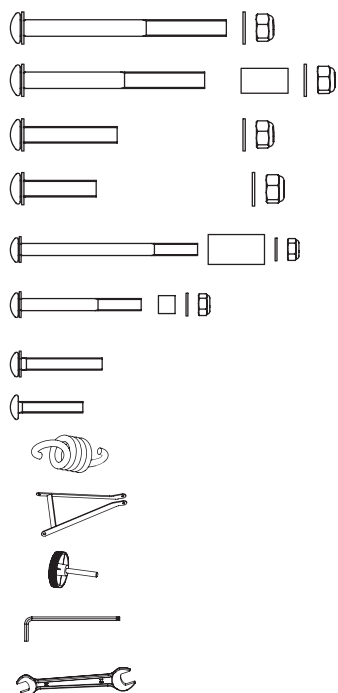

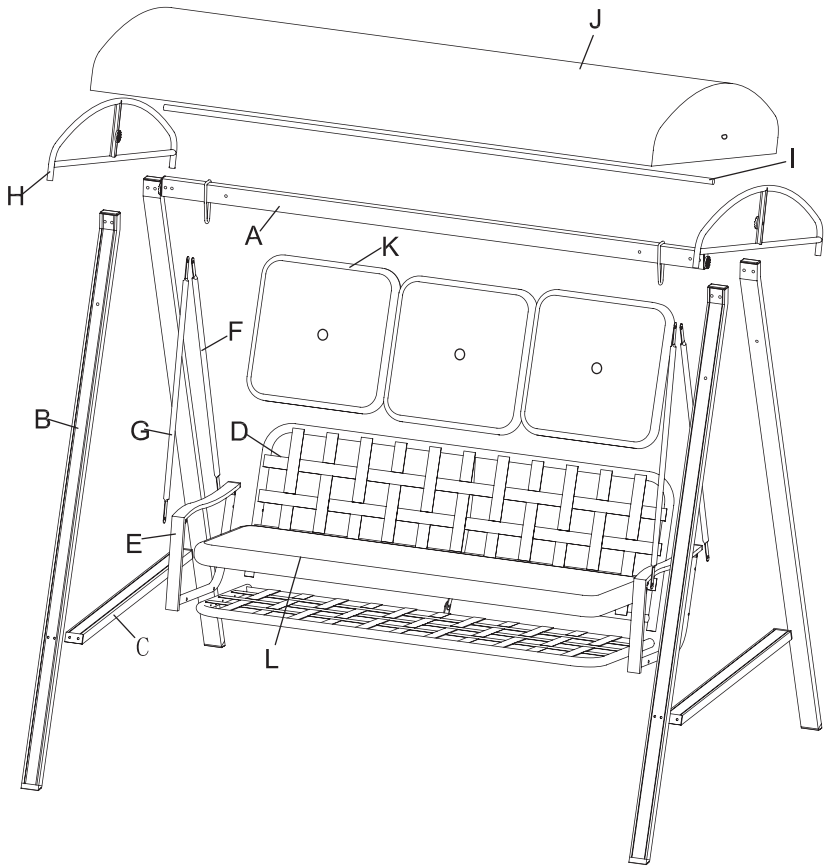

- AA M8X100MM
- BB M8X90MM
- CC M8X50MM
- DD M8X45MM
- EE M6X85MM
- FF M6X60MM
- GG M6X40MM
- HH M6X30MM
- II
- JJ
- KK
- LL
- MM



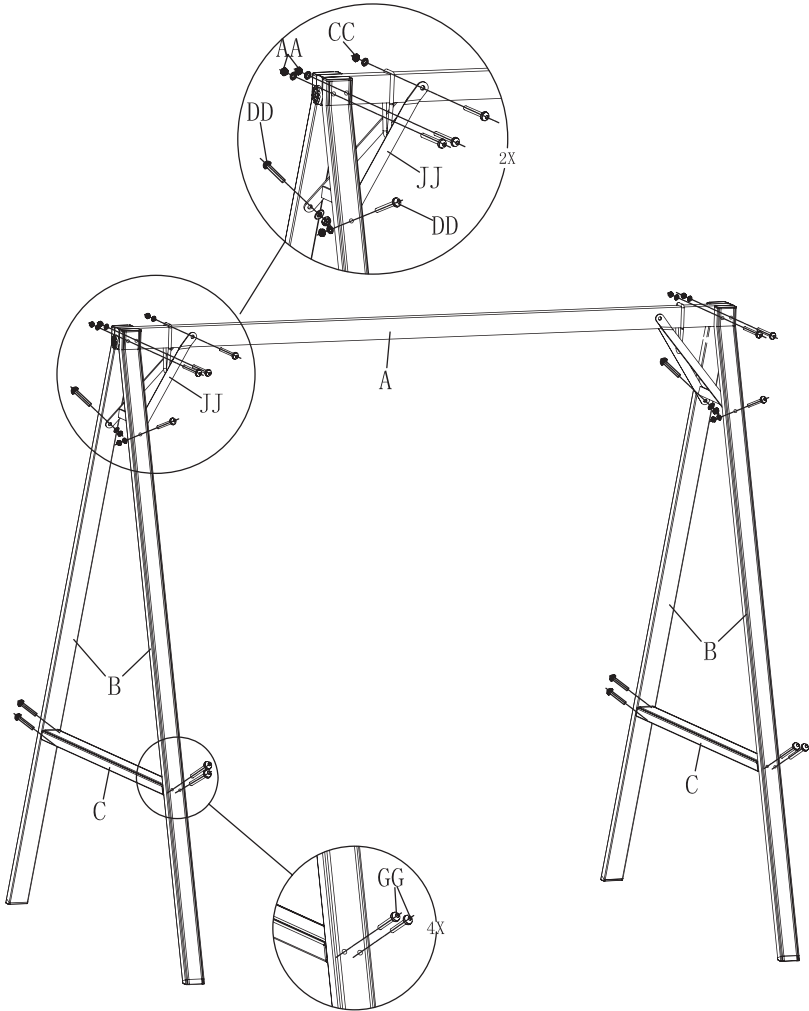





Part	Description	Quantity
A	横架	1
B	脚管	4
C	侧连管	2
D	座背组件	1
E	扶手	2
F	后吊杆	2
G	前吊杆	2
H	顶弯管	2
I	顶直管	1
J	顶布	1
K	背垫	3
L	坐垫	1

- 先用螺丝AA将B与A锁住；然后将A与JJ用螺丝CC锁住；再将B与JJ用螺丝DD锁住；再然后用螺丝GG将B与C锁住；最后将所有螺丝锁紧。







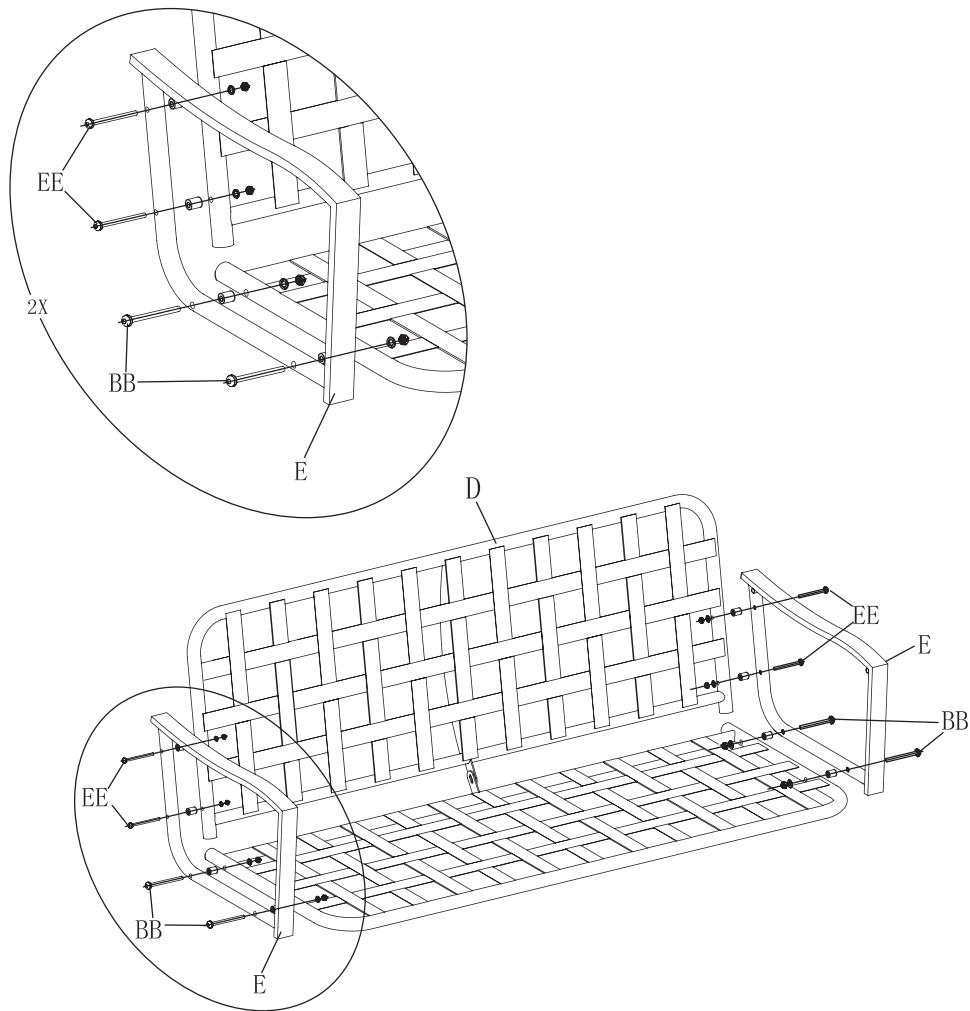

Part	Quantity	Description
A	1	
B	4	
C	2	

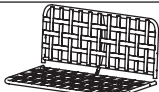
Part	Quantity	Description
AA	4	 4 M8X100MM 组合螺丝
CC	2	 2 M8X50MM 组合螺丝
DD	4	 4 M8X45MM 组合螺丝
GG	8	 8 M8X40MM 组合螺丝
JJ	2	 2
LL	1	 1
MM	1	 1

2. 用螺丝BB将D与E锁住；然后螺丝EE将D与E锁住；
最后将所有螺丝锁紧（包括中间原本松装的螺丝）。

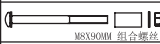





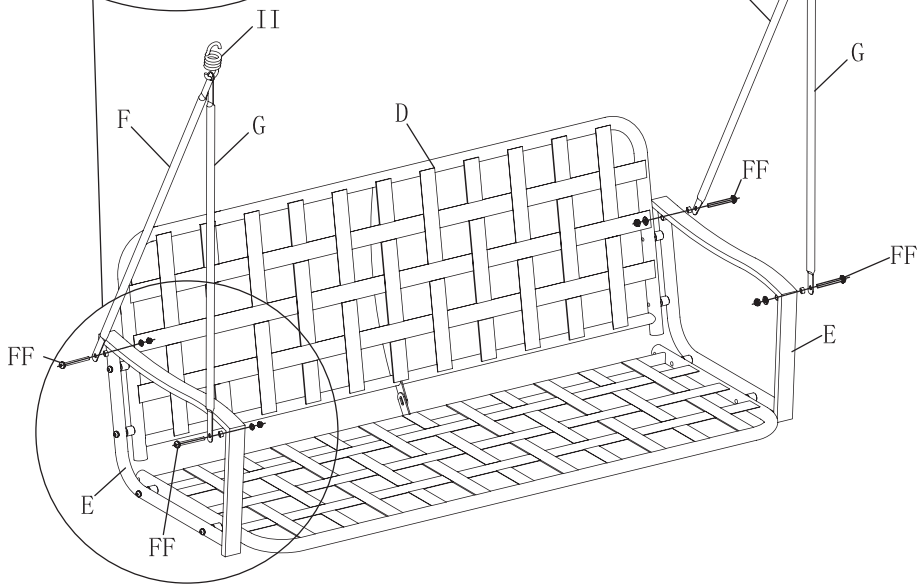
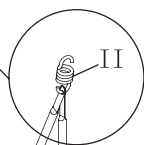
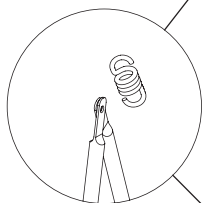
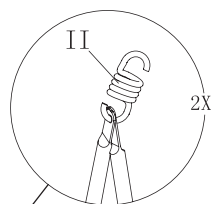
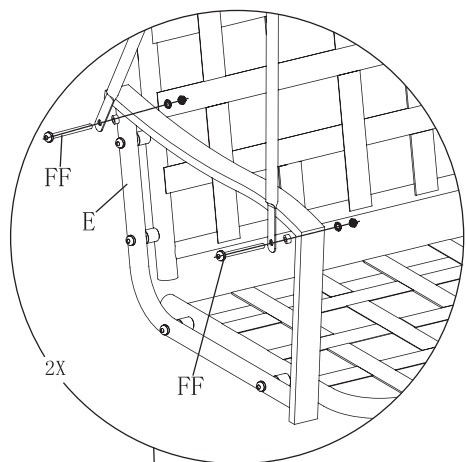

Part	Quantity	Description
D	1	
E	2	

Part	Quantity	Description
BB	4	 M6X90MM 组合螺丝
EE	4	 M6X85MM 组合螺丝
LL	1	
MM	1	

3. 用螺丝FF将F与E锁住；然后用螺丝FF将G与E锁住；
最后将所有螺丝锁紧。





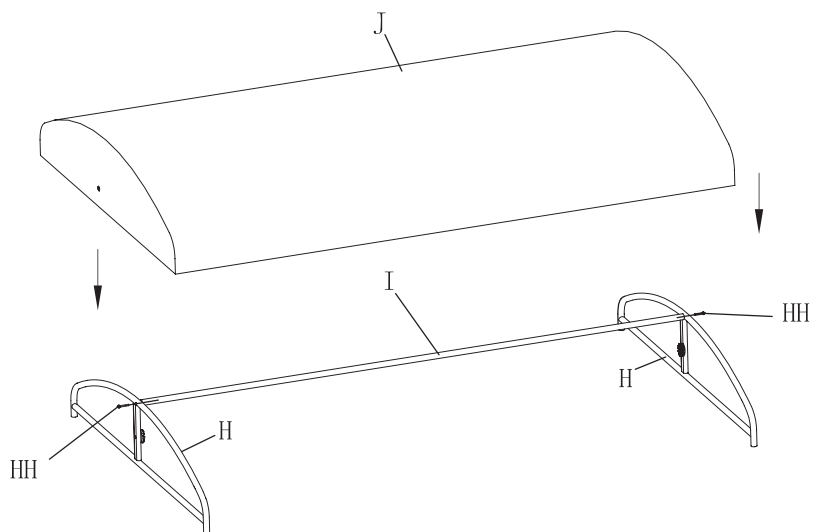
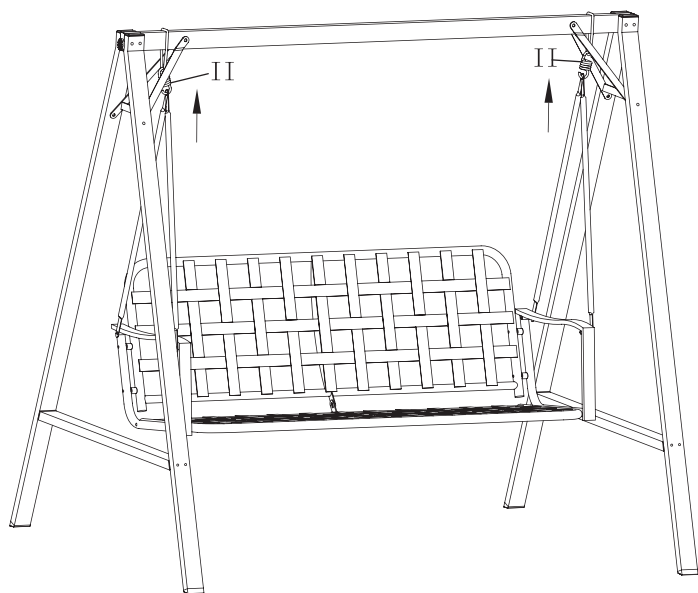

Part	Quantity	Description
F	2	
G	2	

Part	Quantity	Description
FF	4	 组合螺丝
II	2	
LL	1	
MM	1	

4. 将座椅悬挂到架子上；用螺丝HH将H与I锁紧(注意H的方向)，最后将顶布J套上。





Part	Quantity	Description
H	2	
I	1	
J	1	

Part	Quantity	Description
HH	2	 M6X30MM 平圆头螺丝
LL	1	

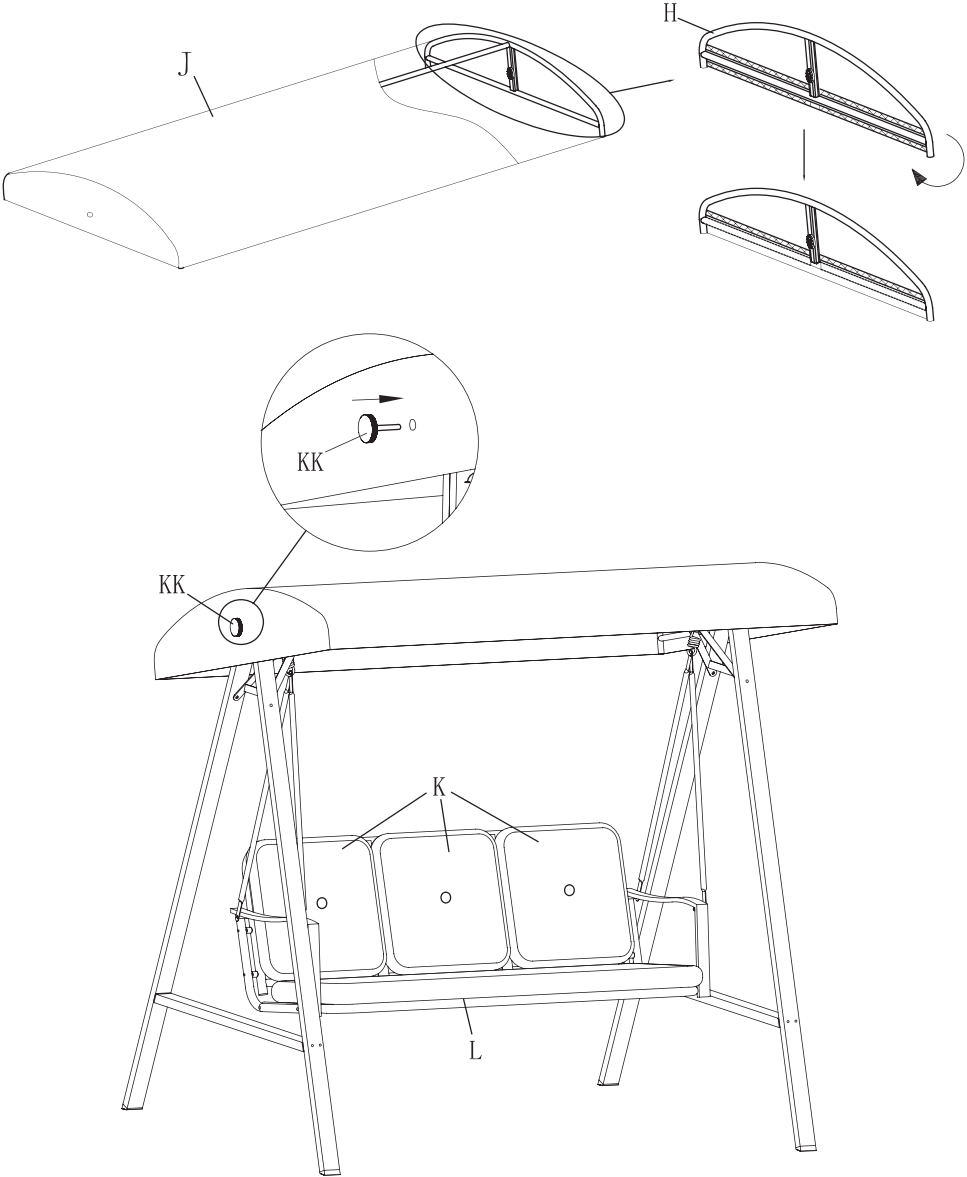
5. 将J两侧的粘扣带粘牢, 然后将整个顶放在架子上, 用KK顺时针
 针拧连接顶, 调整好角度后拧紧, 再将L放在座位上, K放在背上。



Part	Quantity	Description
K	3	
L	1	

Part	Quantity	Description
KK	2	