



Intertek
IMPORTANT: READ AND SAVE THESE INSTRUCTIONS.
FOR RESIDENTIAL USE ONLY.
Revised September 2014
Disclaimer: Item purchased may be slightly different from the manual.

IMPORTANT SAFETY INSTRUCTIONS

WARNING: TO REDUCE THE RISK OF FIRE, ELECTRIC SHOCK, OR INJURY TO PERSONS, READ THE FOLLOWING:

- Use this unit only in the manner intended by the manufacturer. If you have questions, please contact the manufacturer.
- Before servicing or cleaning the unit, switch the power off and turn power off at the electrical panel and lock the service panel. This will prevent the power from accidentally turning on. If the service panel does not lock, secure a warning label, such as a tag, to the service panel.
- Installation work and electrical wiring must be done by a qualified professional(s) in accordance with all applicable codes, standards, and fire-rated constructions.
- Do not operate any fans with a damaged cord or plug. Discard the fan or return to an authorized service facility for further examination and/or repair.
- To prevent back draft, sufficient air is needed for proper combustion. Gas from the fuel burning equipment needs to exhaust through the flue (chimney). Follow the heating equipment manufacturer's guideline and safety standards such as those published by the National Fire Protection Association (NFPA), the American Society for Heating, Refrigeration and Air Conditioning Engineers (ASHRAE), and the local code authorities.
- When cutting, or drilling into walls or ceilings; be aware of electrical wires, piping, and other utilities.
- Ducted fans must always be vented outdoors.

CAUTION: For general ventilation use only. Do not use to exhaust hazardous or explosive materials and vapors.

CAUTION: To reduce the risk of fire and to properly exhaust air, be sure to duct air outside – DO NOT vent exhaust air into attics, crawl spaces, garages, or within walls and ceilings.

WARNING: TO REDUCE THE RISK OF A RANGE TOP GREASE FIRE, READ THE FOLLOWING:

- Never leave surface units unattended at high settings. Boil-over can cause smoke and grease to spill over that may ignite. Heat oils slowly on low or medium settings.
- Always turn range hood ON when cooking at high heat or when cooking food with high flames.
- Clean ventilation fans frequently. Grease should not be allowed to accumulate on fan or filter.
- Use proper pan size. Always use cookware appropriate for the size of the surface element.

WARNING: TO REDUCE THE RISK OF INJURY, IN THE EVENT OF A RANGE TOP GREASE FIRE, READ THE FOLLOWING:

- SMOTHER FLAMES with a close-fitting lid, cookie sheet or metal tray, then turn off the burner. BE CAREFUL TO PREVENT BURNS. If the flames do not go out immediately. EVACUATE AND CALL THE FIRE DEPARTMENT.
- NEVER PICK UP A FLAMING PAN – you may be burned.
- DO NOT USE WATER, including wet dishcloths or towels – a violent steam explosion will result.
- Use an extinguisher ONLY if:
 - You know you have a class ABC extinguisher, and you know how to operate it.
 - The fire is small and contained in the area where it started.
 - The fire department is being called.
 - You can fight the fire with your back to an exit.

Based on “Kitchen Fire Safety Tips” published by NFPA

WARNING: To reduce the risk of fire or electrical shock, do not use this fan with any solid-state speed control device.

LOCATION REQUIREMENTS

IMPORTANT: Observe all governing codes and ordinances. Have a qualified technician install the range hood. It is the installer's responsibility to comply with installation clearances specified on the model/serial rating plate. Canopy hood's location should be away from strong draft areas, such as windows, doors, and strong heating vents. Cabinet opening dimensions that are shown must be used. Given dimensions provide minimum clearance.

ELECTRICAL REQUIREMENTS

Observe all governing codes and ordinances. Ensure that the electrical installation is adequate and in conformance with the National Electrical Codes, ANSI/NFPA 70 (latest edition), or CSA Standards C22.1-94, Canadian Electrical Code, Part 1 and C22.2 No. 0-M91 (latest edition), all local codes, and ordinances. If codes permit and a separate ground wire is used, it is recommended that a qualified electrician determine that the ground path is adequate.

A copy of the above code standards can be obtained from:

1 Batterymarch Park

Quincy, MA 02169-7471

CSA International

8501 East Pleasant Valley Road

Cleveland, OH 44131-5575

- A 120 volt, 60 Hz., AC only, 15-amp, fused electrical circuit is required.
- If the house has aluminum wiring, follow the procedure below:
 - Connect a section of solid copper wire to the pigtail leads.
 - Connect the aluminum wiring to the copper wire using special connectors and/or tools designed and UL listed for joining copper to aluminum. Follow the manufacturer's recommended procedure for the electrical connector. Aluminum/copper connection must conform to local codes and industry accepted wiring practice.
- Wire sizes and connections must conform to the rating of the appliance as specified on the model/serial rating plate. The model/serial plate is located behind the filter on the rear wall of the range hood.
- Wire sizes must conform to the requirements of the National Electrical Code, ANSI/NFPA 70 (latest edition), or CSA Standards C22. 1-94, Canadian Electrical Code, Part 1 and C22.2 No. 0-M91 (latest edition) and all local codes and ordinances.

VENTILATION REQUIREMENTS

General requirements

- Range hoods must be ventilated to the outdoors, except for non-vented (recirculating) installations.
- Do not ventilate the range hood into an attic or other enclosed areas.
- Do not use 4" (10.2 cm) laundry-type wall caps.
- The length of the range hood and the number of elbows should be kept to a minimum to provide maximum performance.

For the most efficient and quiet operation

- Use no more than three 90-degree elbow.
- Make sure there is a minimum of 24" (61 cm) of straight duct between the elbows if more than one elbow is used.
- Do not install two elbows together.
- Use clamps and tape to seal all joints in the vent system.
- The vent system must have a damper. If the roof or wall cap has a damper, do not use the damper supplied with the range hood.
- Use caulking to seal exterior walls or roof openings around the cap.
- The size of the vents should be uniform.

Cold Weather Installations

An additional back draft damper should be installed to minimize backward cold air flow. A thermal break should be installed to minimize conduction of outside temperatures as part of the vent system. The damper should be on the cold air side of the thermal break. The break should be as close as possible to where the vent system enters the heated portion of the house.

Makeup Air

Local building codes may require the use of makeup air systems, when using ventilation systems greater than specified CFM of air movement. The specified CFM varies from state to state. Consult your HVAC professional for specific requirements in your area.

For Non-Vented (recirculating) Installations

If it is not possible to vent cooking fumes and vapors to the outside, certain hoods can be used in the non-vented (recirculating) version, fitting a carbon filter at the motor. Fumes and vapors are recycled through the top grille. DO NOT block the chimney holes.

Calculating Vent System Length

To calculate the length of the system you need, add the equivalent feet (meters) for all vent pieces used in the system.

INSTALLATION DIMENSION RECOMMENDATIONS

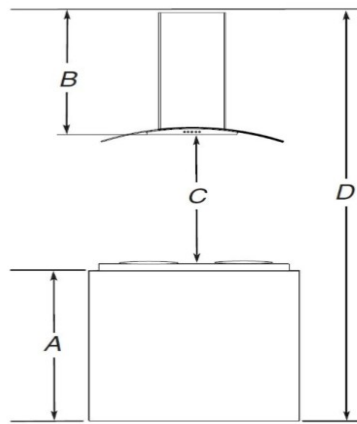

For Island range hoods:

- A. Countertop Height.
- B. Hood height from ceiling to bottom of the range hood filter surface: $D-A-C=B$.
- C. 24" minimum from cooking surface up to 36" maximum for Electric/Induction range tops. 27" minimum from cooking surface up to 36" maximum for Gas range tops.
- D. Floor to ceiling height.

Prior to installation

- Unpack range hood and ensure all listed parts are in the box.
- It is recommended for the vent system to be installed before hood is installed.

- Before making cutouts, make sure there is proper clearance within the ceiling or walls for the exhaust vent.
- Determine which venting method to use: roof or wall.
- **It is recommended that a professional installer perform the range hood installation.**

INSTALLATION INSTRUCTIONS for Island Range Hood

Parts supplied (Note: The fasteners included may not be suitable to your ceiling structure. Please check with the installer on proper fasteners to be used based on the material makeup of your ceiling)

- A. Range Hood
- B. Power Cord (attached to range hood)
- C. 6" or 8" round vent air flap depending on model (attached to range hood on top of unit)
- D. Aluminum or Stainless Steel Filter(s) (attached to the bottom of the range hood)
- E. (8) Support frame brackets. (4) upper and (4) lower
- F. (1) 6" or 8" round flexible duct exhaust hose depending on model
- G. (4) Phillips #10 X 2-3/8 Screw (expandable caps not to be used in some models)
- H. (2) Stainless Steel Ducts (inner and outer)
- I. (66-70) #6 X 3/8 SM Screw. Quantity will vary by model
- J. (1) Ceiling mounting bracket to support either 6" or 8" flexible duct exhaust hose depending on model
- K. (1) Grease collection tray. Will be preinstalled if the model purchased comes with a tray. Not all models contain a grease collection tray.

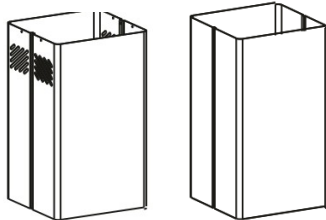
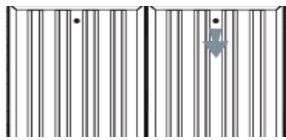
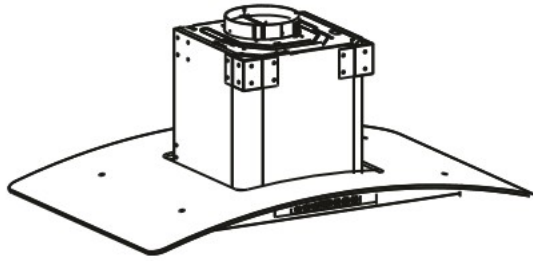



Parts not supplied

- Duct tape
- Preinstalled ventilation system and ductwork
- Preinstalled outside duct cap or weatherproofing

Installing the range hood

This installation is for mounting the product to a ceiling. Ensure your ceiling has the proper support to hold the range hood weight. These instructions are general guidelines, please consult professional installation specialist regarding the best type of mounting hardware and support system based on your ceiling construction. All island range hoods must be installed and supported by studs and joists in your ceiling. All homes constructions are different and installations will vary.

1. Begin installation by removing the filters (D) and removing any tape on the air flow flappers (C).
2. Remove protective film from range hood and ducting. When handling the ducting please wear protective gloves to avoid sharp edges.
3. If your model has an electronic touch sensor control panel, remove the protective plastic film covering the control panel.
4. Find the center of the ceiling where you are installing the range hood and trace a 6" or 8" circle depending on model. You can use the ceiling mounting bracket (J) to help trace your cut out mark. The ceiling mounting bracket is larger than the 6" and 8" opening needed. Ensure there are no studs where the opening is being made.



5. After tracing the cutout circle, using a sabre saw or jig saw, cut out the drywall.



6. This island range hood **must be supported** to the ceiling studs or joists. Create two wooden support braces and slide up through cut out hole in ceiling. Place the support braces on top of the studs or joist. The bottom of the support braces need to align with the four holes on the mounting bracket.

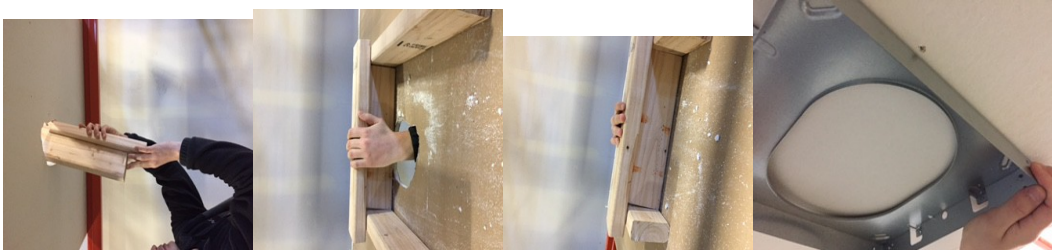

7. Attach the ceiling mounting bracket using the (4) Phillips #10 X 2-3/8 Screws through the mounting bracket openings as shown below (the supplied screws may not work with all installations, please check with your installation professional). The screws must enter the wooden support braces. While screwing into the support brace, reach your hand through the ceiling hole and hold the support brace in place. You may wish to further brace the wooden support braces to the joist by entering your ceiling and adding additional screws.





8. Install the 6" or 8" round flexible duct exhaust hose depending on model. Assemble ventilation to outside ducting using duct tape and/or strapping. **Note: If you are choosing the ductless/recirculating mode do not install the duct exhaust hose.**



9. Attach the (4) upper support frame brackets (E) to the ceiling mounting bracket (J). Each support bracket will use (4) #6 X 3/8 SM Screws (I).

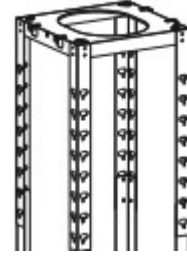

10. Measure the distance that the bottom of the range hood will be from the top of your range (see page 5 for reference). Attach the (4) lower support frame brackets (E) to the **upper** support frame brackets (E). Each support bracket will use (4) #6 X 3/8 SM Screws (I).

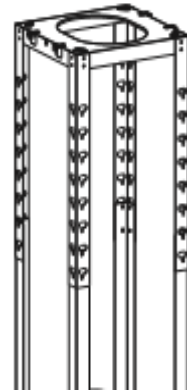
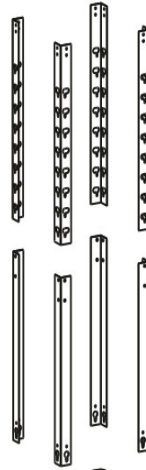
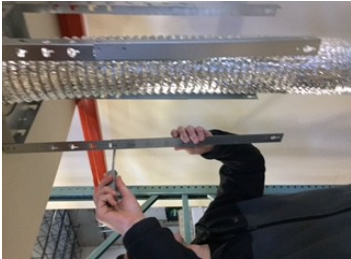

11. Place the range hood underneath the support frames and align the holes of the support frame to holes in the range hood. **Warning: This will take at least two people.** Screw in (4) #6 X 3/8 SM screws through the support frames into the pre-aligned holes in the range hood on all four corners.

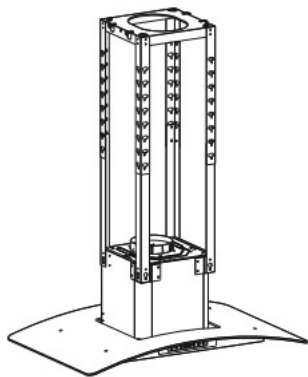

12. Pull power cord (B) up through ceiling cut out and plug into outlet. You may need to access your ceiling. An extension cord may be required. As electrical box locations may vary, please make proper accommodations during the installation process.
13. Detach the inner duct cover (H) by removing the (2) set screws near the upper middle of the attached duct. Inside the duct, there are tongue and groove clips for stability. Lift on side of the duct to detach.

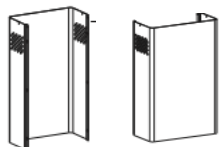

14. Bring the two duct pieces together over the support frame brackets and reattach the (2) set screws. Make sure the tongue and groove clips are realigned. Slide attached duct over the ceiling mount. Be sure the duct slides over the (2) mounting brackets on each side.

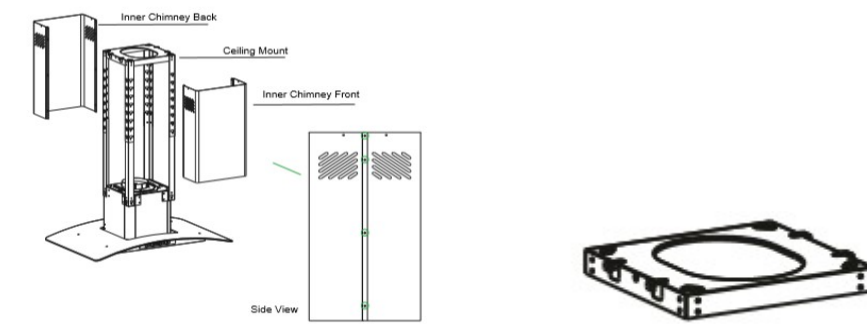

15. The duct should cover the (2) mounting brackets on the sides of the ceiling bracket. Screw in (4) #6 X 3/8 SM screws through the predrilled holes in the duct work into the 4 mounting brackets.

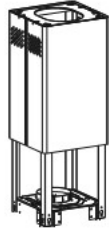

16. Install (1) round flexible duct exhaust hose (F) to round vent air flap (C) (attached to range hood on top of unit) and secure with duct tape. **Note: If you are choosing the ductless/recirculating mode do not install the duct exhaust hose (F).**

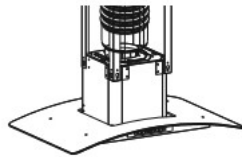

17. Detach the outer duct cover (H) by removing the (2) set screws near the bottom middle of the attached duct. Inside the duct, there are tongue and groove clips for stability. Lift on side of the duct to detach.

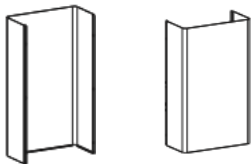

18. Bring the two duct pieces together over the support frame brackets and the upper duct that was attached in step 15. Reattach the (2) set screws. Make sure the tongue and groove clips are realigned.

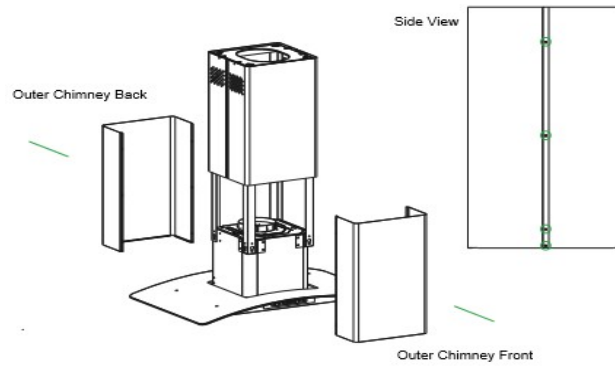

19. Set the bottom duct unto the top of the range hood in the grooved slot. Removing the filters, and from underneath the range hood, screw in (14) #6 X 3/8 SM screws into the pre-drilled holes. This will secure the outer duct to the range hood body.

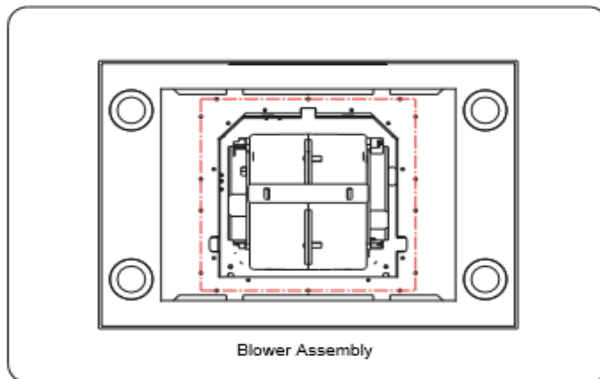

INSTALLATION FOR DUCTLESS (RECIRCULATING) MODE

IMPORTANT: If you are choosing the ductless/recirculating mode do not install the duct exhaust hose (I).

1. Unplug the power cord.
2. Remove the filter panel(s) located at the bottom of the range hood.
3. Remove the motor plate by detaching the (4) screws.

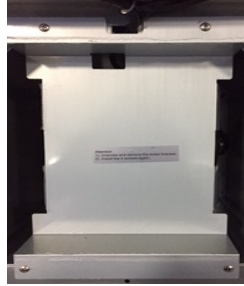

4. Locate the motorized fan inside the hood.
5. Attach the carbon filters (not included, can be purchased: Part number WRHF001S2) to both sides of the motorized fan.
6. Twist the carbon filter until it is in the locking position (separate instructions included with filters).
7. Reattach the motor plate from step 3.
8. Reinstall the filter panel(s), and reconnect the power.

OPERATING INSTRUCTIONS

Note: There are different operating instructions based on the control panel for your model. Please choose the operating instruction for your unit.

Powering on/off and Settings:



- **Lamp:** Press the lamp display one time to activate the light, press the lamp display again to deactivate it.
- **Power/Standby:** When the range hood is in the “original” state, touch this button. It will enter the standby mode.
- **Setting the clock:** When the range hood is on “Standby” Mode, press and hold the timer button for 3 seconds. The range hood will then enter the time setting state; the display screen will show numbers. Press the Plus to set hours and Press the Minus to set the minutes. After 10 seconds, it will automatically exit the time setting state and the time you have entered will be saved.

➤ **Timer:**

- When the fans are operating, touch the timer button one time. This will turn on the timer mode and the display will show 03:00. Each time you press the timer button, it will increase by 1 minute with the maximum timer setting of 60 minutes. Within the last 3 seconds of the timer setting, the range hood will make three beeps.
- When range hood is on, touch the Power/Standby once and the shut off timer will set to 60 seconds. Touch the button twice and the fan will turn off.

➤ **Fan Operation:**

- In standby mode, press the Minus button one time and the range hood will start at F1 speed. If the button is pressed again, the speed will stay the same.
- In standby mode, press the Plus button one time, the range hood will start at F3 speed. If the button is pressed again, the speed will stay the same.
- To lower or increase the fan speed press the Plus or Minus buttons.
- When fan is in the standby mode, press the Fan button to reach maximum speed immediately. Touching this button while in a lower speed will automatically take to the maximum speed. Touching the Fan button twice will turn the fan off.

Powering on/off and Settings:

Lamp Timer Clock Fan Power/Standby

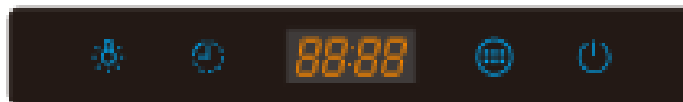

- **Lamp:** Press the lamp display one time to activate the light, press the lamp display again to deactivate it.
- **Power/Standby:** When the range hood is in the “original” state, touch this button. It will enter the standby mode.
- **Setting the clock:** When the range hood is on “Standby” Mode, press and hold the timer button for 3 seconds. The range hood will then enter the time setting state; the display screen will show numbers. Press the Fan button to set hours and press the Lamp button to set the minutes. After 10 seconds, it will

automatically exit the time setting state and the time you have entered will be saved, or press the Timer button to exit and keep saved time.

➤ **Fan Operation:**

- In standby mode, press the Fan button one time and the range hood will start at F3 speed. If the Fan button is pressed again, the speed will reduce to F2. If the Fan button is pressed again, the speed will reduce to F1. Pressing the Fan button after the F1 setting will shut off the fan.

➤ **Timer:**

- When the fans are operating, touch the Timer button one time. This will turn on the timer mode and the display will show a flashing 03:00, after 8 seconds the display will stop flashing and begin counting down. Each time you press the timer button, it will increase by 1 minute with the maximum timer setting of 60 minutes. Within the last 3 seconds of the timer setting, the range hood will make three beeps.
- When range hood is on, touch the Power/Standby once and the shut off timer will set to 60 seconds. Touch the button twice and the fan will turn off.

Powering on/off the unit

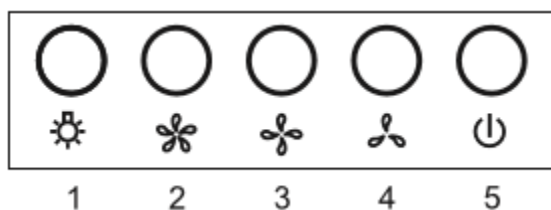

➤ To turn the fan on push a button to select one of the 3 speeds:

- 2=High
- 3=Medium
- 4=Low

If you choose a new speed by pressing a different button, the new fan speed will replace the old fan speed.

➤ To turn fan off push button 5.

➤ To operate light on/off push button 1. (Note: The fan and light operate independently of each other).

Powering on/off and Settings:

Lamp Timer Minus

Plus Fan Power/Standby



- **Lamp:** Press the lamp display one time to activate the light, press the lamp display again to deactivate it.
- **Power/Standby:** When the range hood is in the “original” state, touch this button. It will enter the standby mode.
- **Setting the clock:** When the range hood is on “Standby” Mode, press and hold the timer button for 3 seconds. The range hood will then enter the time setting state; the display screen will show numbers. Press the Plus to set hours and Press the Minus to set the minutes. After 10 seconds, it will automatically exit the time setting state and the time you have entered will be saved.
- **Timer:**
 - When the fans are operating, touch the timer button one time. This will turn on the timer mode and the display will show 03:00. Each time you press the timer button, it will increase by 1 minute with the maximum timer setting of 60 minutes. Within the last 3 seconds of the timer setting, the range hood will make three beeps.
 - When range hood is on, touch the Power/Standby once and the shut off timer will set to 60 seconds. Touch the button twice and the fan will turn off.
- **Fan Operation (this control panel comes with either a 3-speed or 5-speed fan):**
 - **For 3-speed fan:**
 - In standby mode, press the Minus button one time and the range hood will start at F1 speed. If the button is pressed again, the speed will stay the same.
 - In standby mode, press the Plus button one time, the range hood will start at F3 speed. If the button is pressed again, the speed will stay the same.
 - To lower or increase the fan speed press the Plus or Minus buttons.
 - When fan is in the standby mode, press the Fan button to reach maximum speed immediately. Touching this button while in a lower speed will automatically take to the maximum speed. Touching the Fan button twice will turn the fan off.
 - **For 5-speed fan:**
 - In standby mode, press the Minus button one time and the range hood will start at F1 speed. If the button is pressed again, the speed will stay the same.
 - In standby mode, press the Plus button one time, the range hood will start at F6 speed for 5 seconds for an initial suction burst then it will automatically reduce to F5 speed. If the button is pressed again, the speed will stay the same.
 - To lower or increase the fan speed press the Plus or Minus buttons.

- When fan is in the standby mode, press the Fan button to reach maximum speed immediately. Touching this button while in a lower speed will automatically take to the maximum speed. Touching the Fan button twice will turn the fan off.

Powering on/off and Settings:

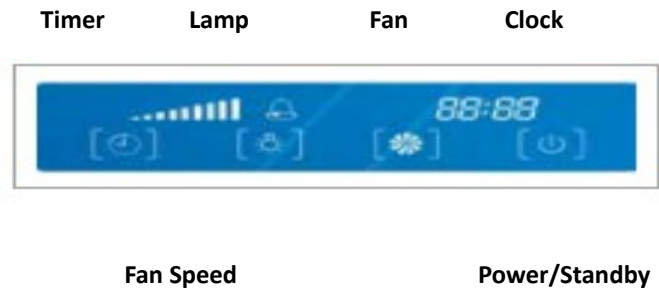

- **Lamp:** Press the lamp display one time to activate the light, press the lamp display again to deactivate it.
- **Power/Standby:** When the range hood is in the “original” state, touch this button. It will enter the standby mode.
- **Setting the clock:** When the range hood is on “Standby” Mode, press and hold the timer button for 3 seconds. The range hood will then enter the time setting state; the display screen will show numbers. Press the Fan button to set hours and press the Lamp button to set the minutes. After 10 seconds, it will automatically exit the time setting state and the time you have entered will be saved, or press the Timer button to exit and keep saved time.
- **Fan Operation:**
 - In standby mode, press the Fan button one time and the range hood will start at high speed (all nine bars will be illuminated on the fan speed bar). If the Fan button is pressed again, the speed will reduce to medium (six bars will be illuminated). If the Fan button is pressed again, the speed will reduce to low (three bars will be illuminated). Pressing the Fan button after the low speed setting will shut off the fan.
- **Timer:**
 - When the fans are operating, touch the Timer button one time. This will turn on the timer mode and the display will show a flashing 01:00, after 8 seconds the display will stop flashing and begin counting down. Each time you press the timer button, it will increase by 1 minute with the maximum timer setting of 60 minutes. Within the last 3 seconds of the timer setting, the range hood will make three beeps.
 - When range hood is on, touch the Power/Standby once and the shut off timer will set to 60 seconds. Touch the button twice and the fan will turn off.

CARE and MAINTENANCE

Cleaning

IMPORTANT: Clean the hood and panel filters frequently per the following instructions. Replace the panel filters before operating hood.

Exterior Surfaces

To avoid damage to the exterior surface, do not use steel wool or soap filled scouring pads. Always wipe dry to avoid water marks.

Cleaning Method

Use liquid mild-detergent soap and water, do not use hard abrasive cleaners.

Wipe with damp soft cloth or non-abrasive sponge, then rinse with clean water and wipe dry.

Do's:

- Clean your range hood using a non-abrasive cloth or sponge and liquid detergent.
- Always wipe in the direction of the grain pattern.
- After cleaning rinse with water.

- Make sure range hood is dry after cleaning.

Don'ts:

- Do not use steel wool or like products as this will cause scratching and iron residue that could lead to rusting and corrosion.
- Do not wipe against the grain pattern as this will impact the original finish.
- Do not use chlorine bleach.

Grease/Baffle Filter

- Remove the filter by pulling the spring release handle and then pulling down the filter.
- Wash filters as needed in dishwasher or hot detergent solution (low temperature, short cycle).
- If your model has a grease tray, please remove, drain and clean periodically.
- Make sure filters are completely dry before putting back into range hood.
- Reinstall the filter by making sure the spring release handles are toward the front. Insert filter into upper track.
- Push the spring release handle.
- Push up on filter and release handle to latch into place.

Replacing the LED light (Replacement Bulb Part Number: WRHLB1S2)

- Turn off the range hood and allow the LED light to cool.
- To avoid damage or decreasing the life of the new bulb, do not touch bulb with bare fingers. Replace bulb wearing cotton gloves to handle bulb.
- If new LED light does not operate, make sure the lamps are inserted correctly before calling for support.

To replace:

1. Disconnect the power cord to ensure unit does not turn on.
2. Remove filters.
3. Reach behind the light and push towards you until the light pops out. A screwdriver may be needed to push out light in some models.
4. Disconnect the electrical harness.
5. Attach new bulbs to the electrical harness.

6. Snap bulbs back into unit and replace filters.
7. Reconnect the power cord.

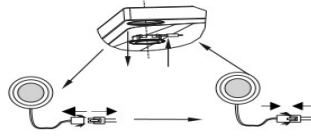

LIMITED WARRANTY

This warranty extends to the original purchaser only. This warranty is not transferable, between homes or owners and is only applicable to residential use. Winslyn Industries, LLC provides a 3-year limited parts warranty for all range hoods. Under this warranty, you (the customer), is entitled to replacement parts at no cost to repair and restore functionality if any part of the product were to fail. No labor is provided. Certain consumables that are not covered under this warranty include Lights (halogen and LEDs), Carbon Filters, Mesh or Baffle Filters, Ducting. These parts are guaranteed to last one year beginning from the date of purchase. If they fail prematurely or are defective within 1 year of purchase, we will replace them at no charge. If a main unit or complete replacement needs to be sent, Winslyn Industries, LLC will require that the customer pay for shipping. Shipping for parts are free under the warranty period. We will provide replacement parts at no charge under normal use and service. We provide you with complete instructions on how to maintain and care for this product. We will not be responsible for due to lack of maintenance or proper use. The original sales receipt, order number, and/or proof of purchase must be presented at the time of the warranty claim, without exception. As noted in the instructions we recommend the use of a professional installer. Winslyn Industries, LLC will not be held responsible for any damage or product failure due to improper installation, misuse, or failure to use a licensed professional. This warranty only extends for household product use, this warranty will be void for commercial use of this product. This warranty will not be applicable if product is purchased from an unauthorized seller. By purchasing this product, buyer agrees that we are not liable for incidental, consequential, or special damages associated with the return, replacement, installation or use of your product. This includes freight costs, labor, travel time, lost profit, home damages and other contingent liabilities and costs (including, without limitation, costs associated with experts, investigations, analyses, attorneys and other professionals and services). Our warranty is a comprehensive and explicit limit of liability, and all items outside of it are not addressable by or the responsibility of Winslyn Industries, LLC. Certain states have variances regarding implied warranties and in those situations, we remain fully compliant. We make no implication that products comply with any or all local building or plumbing codes. It is the consumer's responsibility to determine local building code. Please write or contact us at:

Winslyn Industries, LLC
1232 Hardt Circle
Bartlett, Illinois 60103
Email: support@winslyn.com

