

ASSEMBLY INSTRUCTION

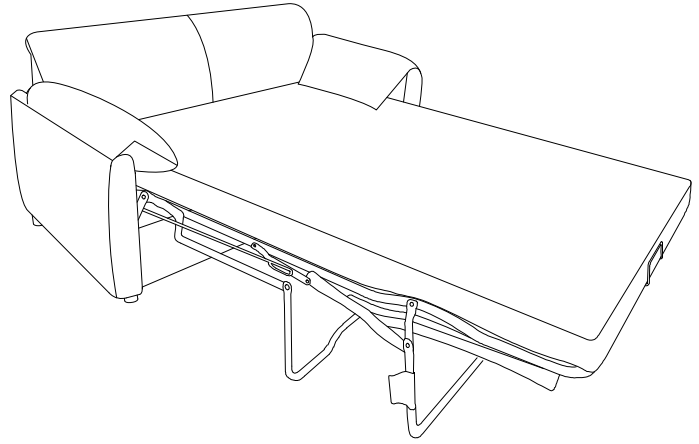

A

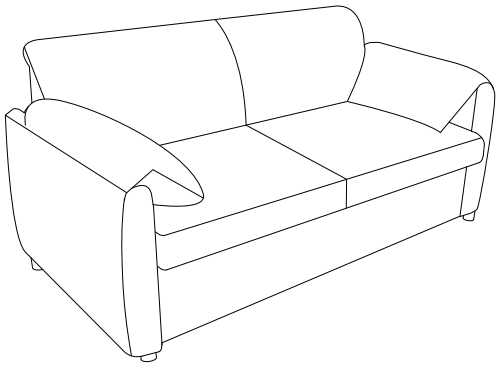
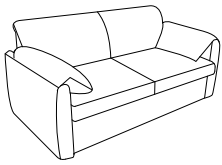

X1

B



X4

STEP 1:

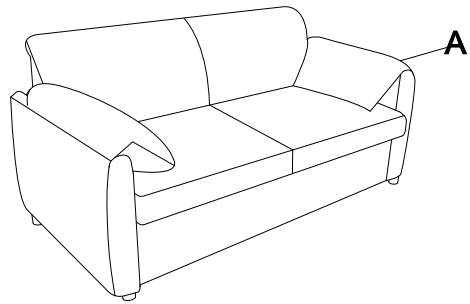
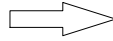
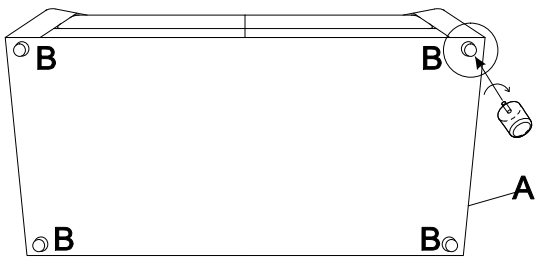

STEP 2:

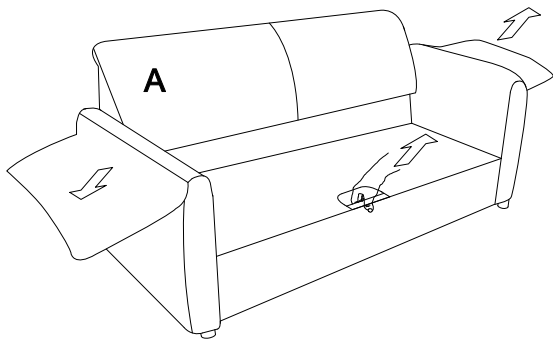

STEP 3:

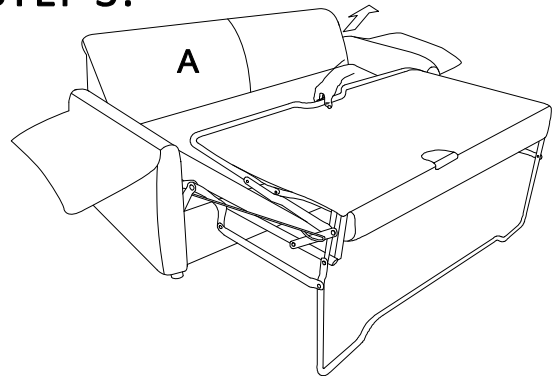

STEP 4:

