

SPARE PARTS

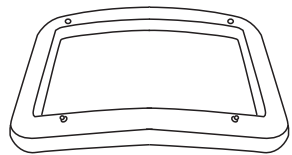

Ax1

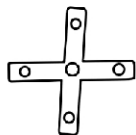

Ex1

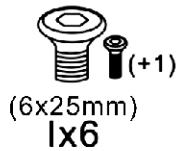

(6x25mm)
1x6

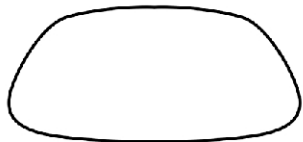

Bx1



Fx1

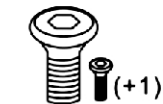

(6x35mm)
Jx2

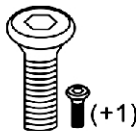

(6x60mm)
Kx5

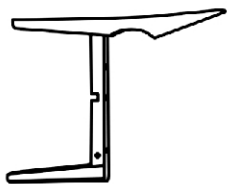

Cx1



Gx13



Lx1

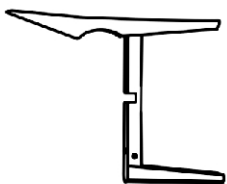

Dx1



Hx13



Mx4

ASSEMBLY INSTRUCTIONS

1

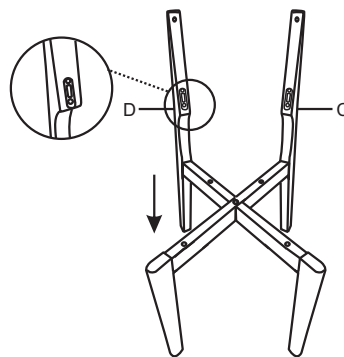

2

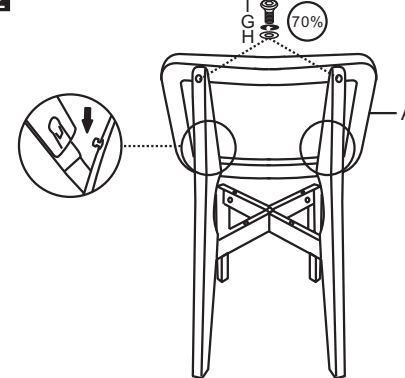

Note:

1. Insert the backrest (A) vertically into the groove on the wooden frame (C,D).
2. When installing, align one side of the screw and screw it in, then tighten the other side. If there is a slight deviation in the hole position, external force can be used to align it.
3. Be careful during installation to prevent scratches on the backrest.

3

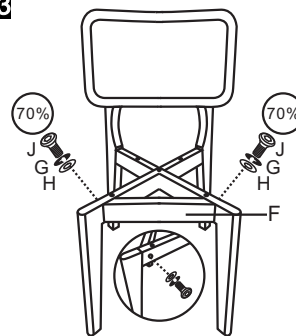

4

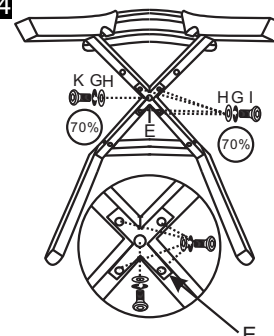

5

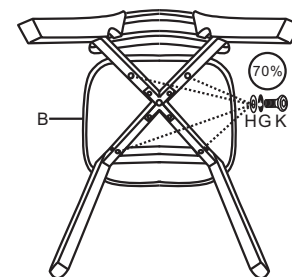

6

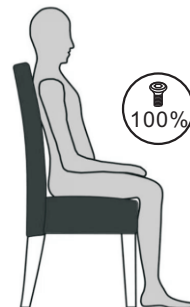

7

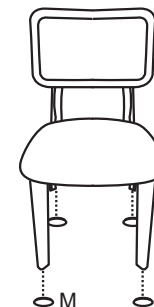

8

