

# Assembly Instructions

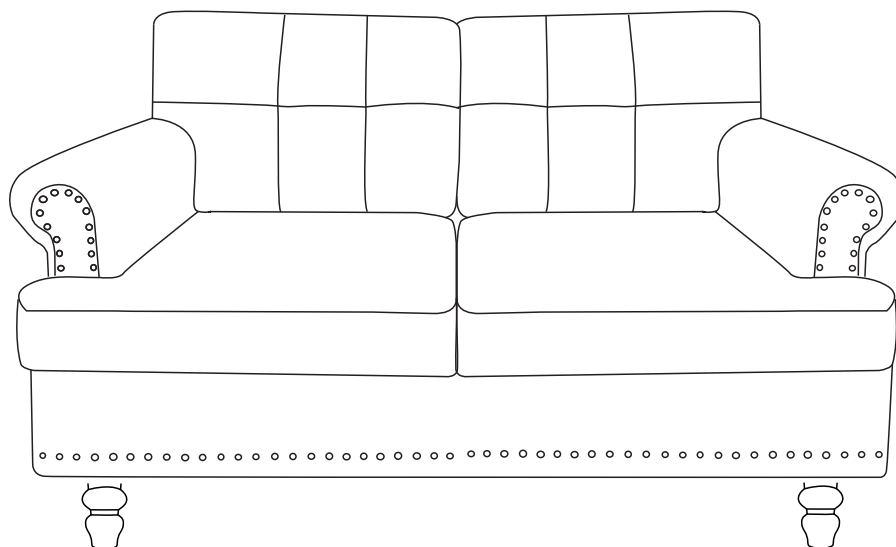

**ITEM NO. E046-019**

**NOTE:** Please read these instructions carefully before starting assembly

## HASSEL-FREE WARRANTY

We proudly provide 1-YEAR warranty, if there are any questions with the products, please feel free to contact with us.

Email : [furniture01service@gmail.com](mailto:furniture01service@gmail.com)



The assembly will be easier with 2 people while 1 person could also do the job.



Around 10 MIN ASSEMBLY

# MAINTENANCE AND WARNING

- Keep furniture away from heat sources.
- Do not clean furniture with harsh cleaner or polishes. Do not use detergents, Solvents, abrasives, spray packs or leather cleaner. Use non-color mild soap with warm water to clean spills(Mix 1:10 soap to water)
- Do not place furniture under direct sunlight, material will possibly fade over time.
- Do not use on site dry Cleaning machine.
- Children should not climb or jump on the furniture.
- Do not write on furniture that is not protected by a padded barrier .



Weight Limitation

**250LBS**

# PART LIST & HARDWARE

1

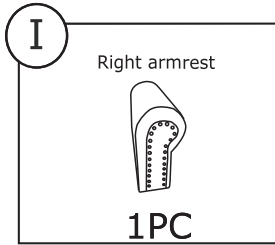
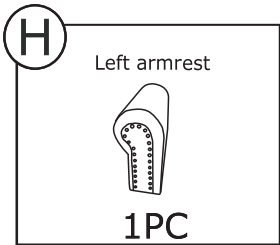

3

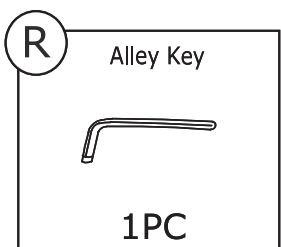
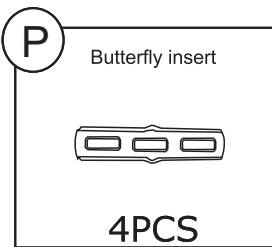
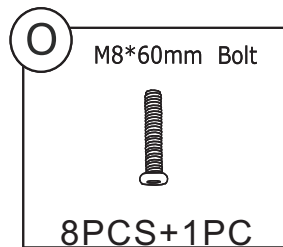
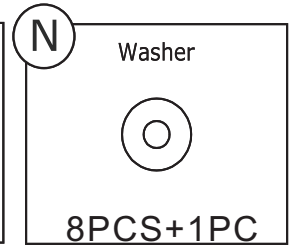
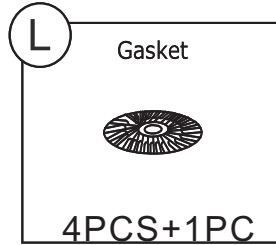
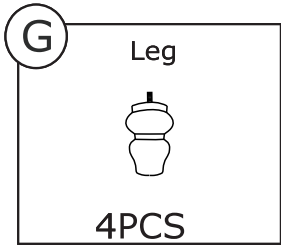
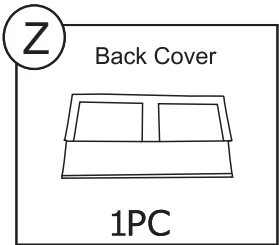
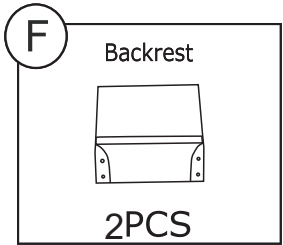
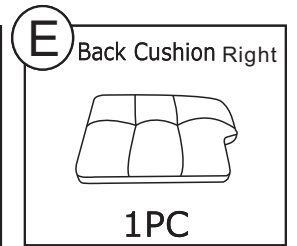
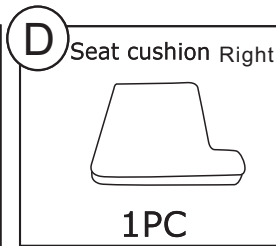
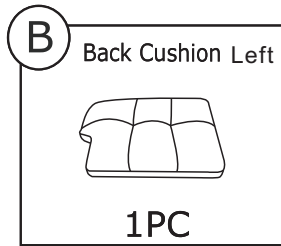
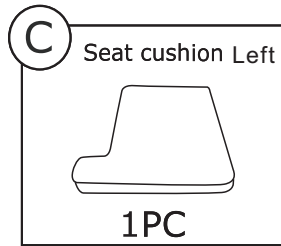
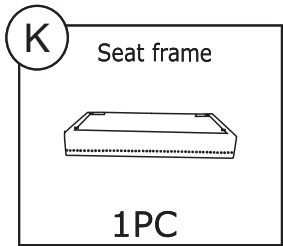

Be sure to inspect all packing material carefully for small parts, that may have come loose inside the carton during shipment.

# ASSEMBLY INSTRUCTIONS

STEP 1: Assemble the Left armrest (H) to the Seat frame (A) with Butterfly insert (P)

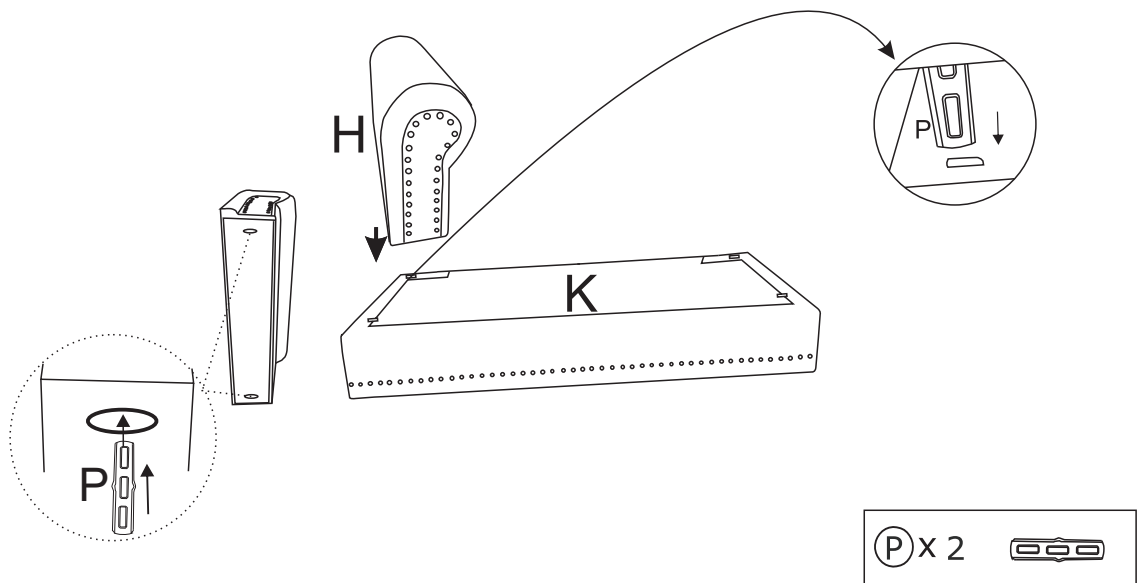

STEP 2: Assemble the Right armrest (I) to the Seat frame (A) with Butterfly insert (P)

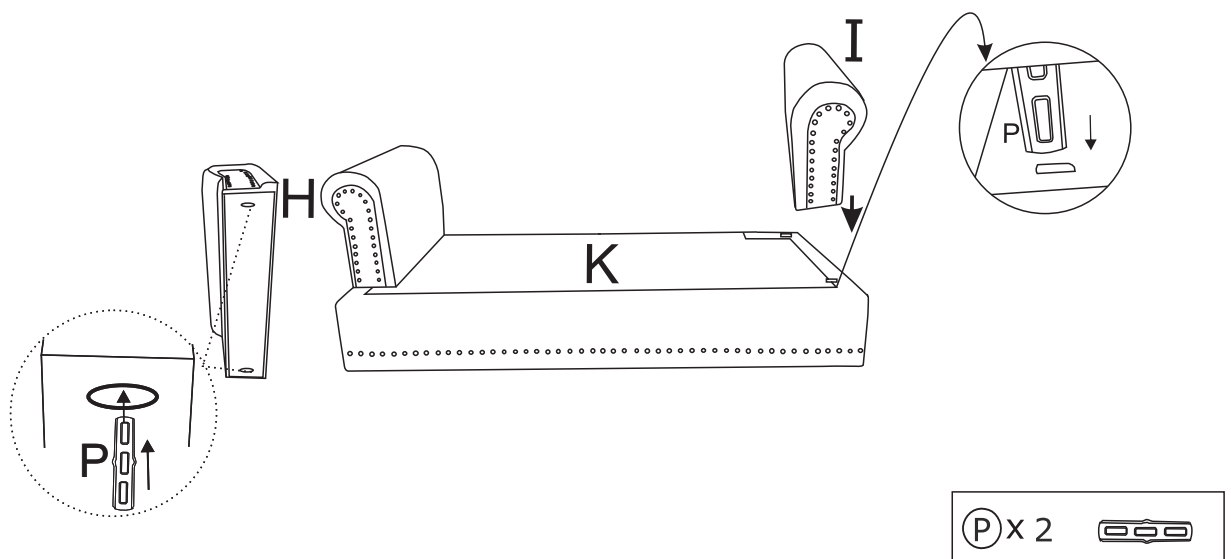

STEP 3: Assemble the Legs (G) on the sofa with Gaskets (L).

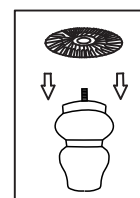
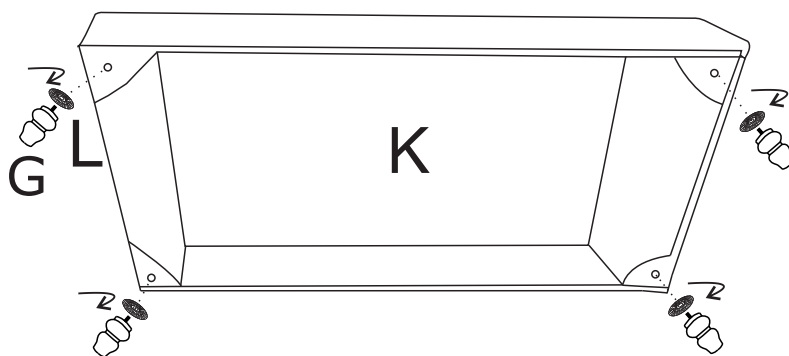

STEP 4: Insert the Backrest (F) into the designated holes, using Washer (N) and Bolts (O) to 70% tightness, and then tighten all Bolts on the seat.

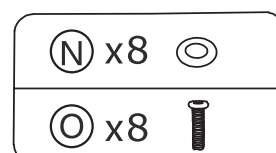
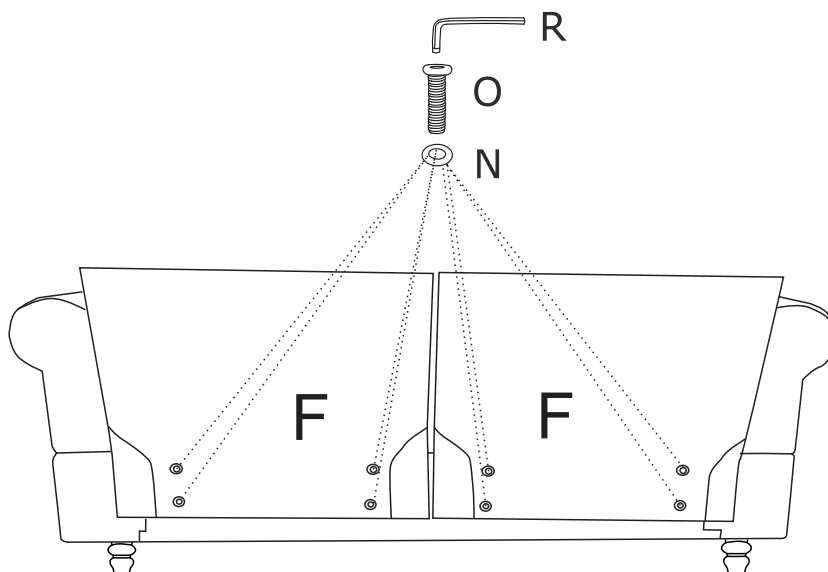

STEP5 : The cushions is packaged by vacuum compression. After cutting the package, it rebounds quickly within 4 hours. If the fabric has wrinkles, it will basically disappear after standing for 72 hours

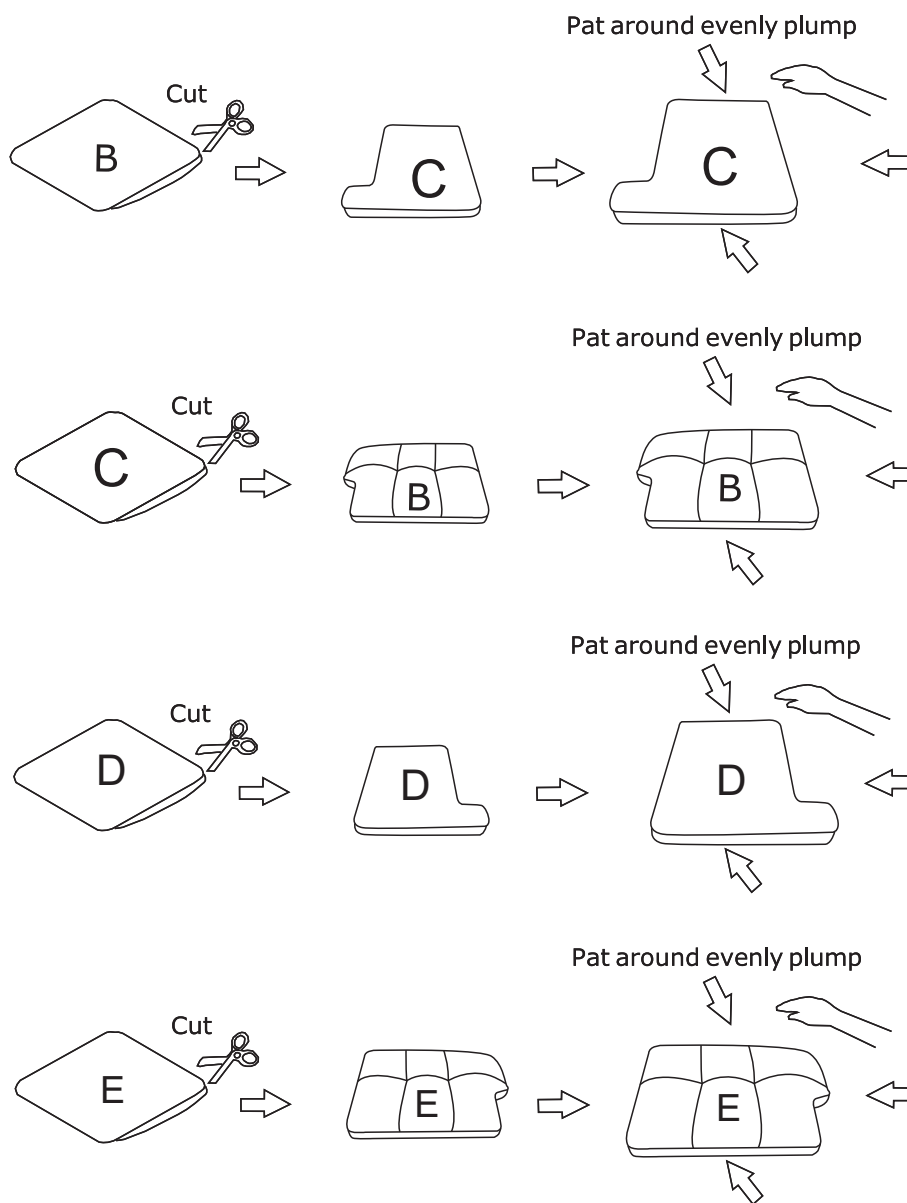

STEP6 : Put the Back Cover on the back fame.

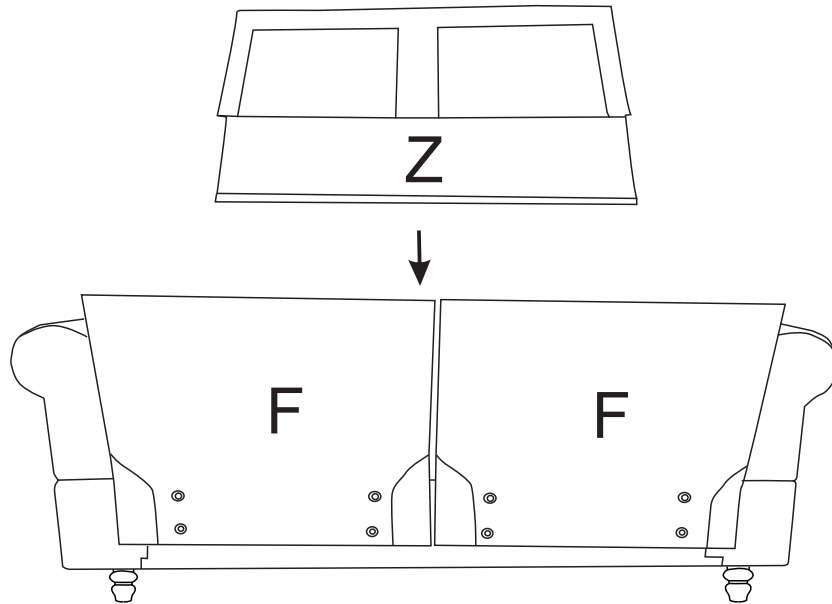

STEP7 : Place Seat Cushions (B,D) and Back Cushions (C,E), and make sure it's will fitted.

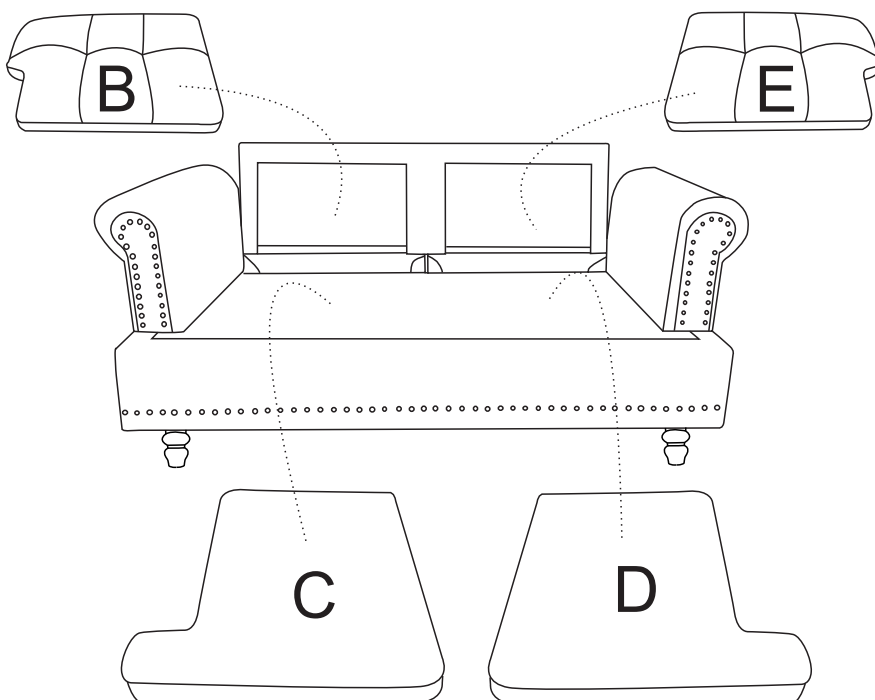

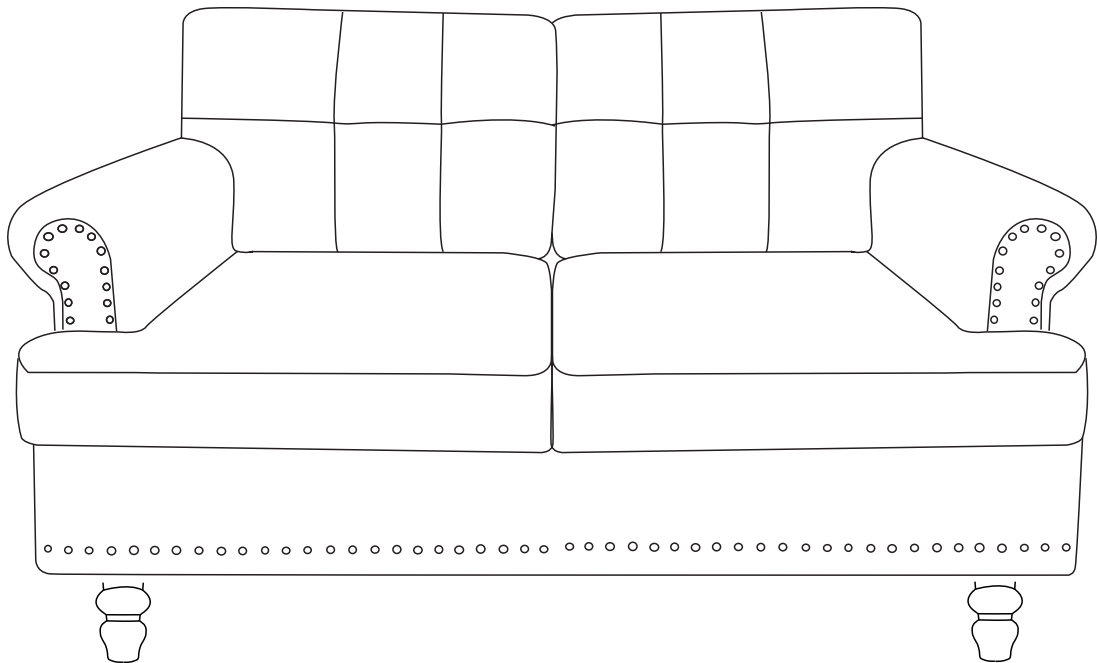

Complete assembly

# **WARRANTY**

We strive to offer high-quality products, and we also try our best to satisfy each and every customer that orders from us with product or service as needed. We provide 1 year warranty starting from the time you receive the item. Each customer must provide a record of their order such as the order number, or item receipt for any items that are out of the warranty period, you may also still receive replacement parts by purchasing them with our company if they are available.

**Are you having difficulty  
with assembly? Missing parts?**

**Please send email with your order No to  
[furniture01service@gmail.com](mailto:furniture01service@gmail.com)**

**For return, please check the return policy with  
the retailer or market place you bought from.**

**Appreciate your purchasing from us.  
Pop up your life by our furniture piece!**