

Furniture Care and Cleaning

FOLLOWING THESE FEW BASIC STEPS WILL HELP YOU ENJOY AND PROTECT YOUR INVESTMENT FOR YEARS TO COME.

Do not expose your furniture to any liquids.

All liquids should be wiped up immediately with a soft, slightly damp cloth in the direction of the wood grain.

For stone surfaces, liquids should be immediately soaked up with a paper towel and wiped dry to avoid any staining.

Do not expose your furniture to strong or direct sunlight, heat outlets, open windows and dampness.

Excessive exposure to sunlight can cause fading of your furniture finish.

Extreme temperatures and humidity changes can cause cracking and splitting.

Do not place rubber or plastic materials on the wood finish.

Chemicals within the plastic or rubber may react with the finish if left in contact for a long period of time.

Place a strip of felt or cork under your accessories to avoid any markings.

Never place hot objects on any furniture surface.

Dust with a clean, damp, lint free cloth.

Frequent dusting will remove abrasive build up, which can damage a finish over time.

Small scratches and marks can be touched up or covered with a mar or scratch remover or a touch up stick. These can be purchased from any paint or hardware store.

Consignes d'entretien de vos meubles

EN SUIVANT CES CONSIGNES DE BASE, VOUS PROTÉGerez ET APPRÉCIEREZ VOTRE INVESTISSEMENT POUR LES ANNÉES À VENIR.

Ne pas renverser de liquide sur vos meubles.

Tout liquide doit être immédiatement essuyé avec un chiffon légèrement humide dans la direction du grain du bois.

Pour les surfaces en Pierre, les liquides doivent être immédiatement épongés avec une serviette de papier et séchés afin d'éviter tout risque de tâche.

Ne pas laisser les meubles directement en contact avec la lumière du soleil, les sources de chaleur, les fenêtres ouvertes et l'humidité.

Une exposition excessive à la lumière du soleil pourrait entraîner la décoloration de la finition de votre meuble.

Les températures extrême et l'humidité peuvent provoquer des fissures et des craquements.

Ne pas poser de matériaux en caoutchouc ou en plastique sur le bois.

Les agents chimiques contenus dans le plastique ou le caoutchouc pourraient interférer avec la finition du meuble sur la durée.

Placer un morceau de feutrine ou du liege sous vos accessoires afin d'éviter tout risqué de marque.

Ne jamais laisser d'objets chauds sur un meuble.

Toujours mettre une assiette chaude entre le haut de votre meuble et un objet chaud afin de le protéger de la chaleur.

Dépoussiérer avec un chiffon propre, légèrement humide et sans trace de peluche.

Dépoussiérer fréquemment enlèvera les risques d'accumulation abrasive pour la finition sur la durée. Les petites traces de rayures et coups peuvent être retouchées ou recouvertes par un stick ou une lotion prévue à cet effet. Ces produits peuvent être achetés chez tout quincailler.

Cuidado y limpieza de sus muebles

LOS SIGUIENTES PASOS BÁSICOS LE AYUDARÁ A DISFRUTAR Y PROTEGER SUS INVERSIONES DURANTE MUCHOS AÑOS.

No exponga su mueble a líquidos.

Cualquier líquido debe ser limpiado inmediatamente usando una tela suave y húmeda en dirección con el corte de la madera.

Para superficies consistiendo de roca, los líquidos deben ser extraídos usando una servilleta de papel y limpiarse hasta dejar seco para evitar manchas.

No exponga su mueble a altas temperaturas, fuertes rayos de sol, humedad y ventanillas abiertas.

El exceso de sol puede causar cambios de color.

Extremas temperaturas y cambios de humedad pueden causar cuartaduras.

No coloque objetos de plástico o hule sobre un acabado de madera.

Substancias químicas contenidas en el plástico o hule pueden causar una reacción si son dejadas por un largo periodo. Siempre proteja su mueble usando algún objeto apropiado o tela debajo de sus accesorios para evitar manchas.

Nunca coloque objetos calientes sobre la superficie de su mueble.

Siempre coloque un plato entremedio de cualquier objeto caliente.

Sacuda y limpie su mueble usando una tela suave, húmeda y que no contenga exceso de fibra.

Las acumulaciones sobre la superficie de su mueble pueden dañar su mueble. Estas pueden ser evitadas limpiando su mueble frecuentemente.

Imperfecciones y rayones pequeños pueden ser retocados o cubiertos usando plumones o líquidos diseñados específicamente para muebles.

Estos pueden ser obtenidos en cualquier tienda de pintura o ferretería.

Fabric/Upholstered Product Care Cleaning Codes

Fabric cleaning codes determine the best and least expensive methods of home cleaning for your furniture. Due to the various ways that furniture can be stained or damaged, there is no guarantee that the results will be completely successful. Use the suggested methods at your own discretion. Always pretest on a small area before proceeding.

To prevent overall soil from dust and grime, frequent vacuuming or light brushing is recommended. Use a professional cleaning service when an overall soiled condition has been reached.

- W - Water Based Cleaner

Spot clean using the foam only from a water-based cleaning agent such as a mild detergent or non-solvent upholstery shampoo product. Apply foam with a soft brush in a circular motion. Vacuum when dry.

- S - Solvent Cleaner

Spot clean using mild water-free solvent or dry-cleaning product. Clean only in a well-ventilated room and avoid any product containing Carbon Tetrachloride or other toxic materials.

- WS - Water / Solvent Cleaner

Spot clean with a mild solvent, an upholstery shampoo or the foam from a mild detergent. When using a solvent or dry-cleaning product, follow the instructions carefully and clean only in a well-ventilated room. Avoid any product that contains Carbon Tetrachloride or other toxic materials. With either method, pretest a small area before proceeding.

- X - Vacuum Only

Clean this fabric only by vacuuming or light brushing to prevent accumulation of dust and grime. Water-based foam cleaners or solvent-based cleaning agents of any kind may cause excessive shrinking, staining or distortion of the surface pile and therefore should not be used.

- D - Dry Clean Only

Soins de produits rembourrés à finition de tissu Codes de nettoyage

Les codes de nettoyage déterminent les moyens les plus efficaces et économiques pour nettoyer à la maison. En raison de la variété infinie de taches ou dommages possibles, il n'est pas garanti que les résultats seront toujours concluants. L'utilisation des moyens suggérés est selon votre discrétion propre. Toujours faire un essai sur une petite surface avant de poursuivre.

Pour prévenir une atténuation de l'apparence, il est recommandé de brosser légèrement ou de passer l'aspirateur régulièrement. Si des souillures de longue date sont présentes, faites appel au service de

professionnels.

- W - (nettoyants à base d'eau)

Nettoyez les taches locales seulement à l'aide de la mousse d'agents nettoyants à base d'eau tel les détergents doux ou produits de type shampoo pour meubles rembourrés. Appliquez la mousse à l'aide d'une brosse souple en un mouvement circulaire. Après séchage, passez l'aspirateur.

- S - (solvants nettoyants)

Nettoyez les taches locales à l'aide d'un produit solvant sans eau ou de nettoyage à sec. Travaillez seulement dans une pièce bien aérée et évitez tout produit contenant du tétrachlorure de carbone ou autre produit toxique.

- WS - (produits nettoyants à base d'eau et solvants nettoyants)

Nettoyez les taches locales avec un nettoyant solvant doux, un shampoo pour meuble rembourré ou la mousse d'un produit détergent doux. Lors de l'utilisation d'un nettoyant solvant ou produit de nettoyage à sec, suivez rigoureusement les instructions du fabricant et travaillez dans une pièce bien aérée. Évitez tout produit comprenant du tétrachlorure de carbone ou tout autre produit toxique. Quelle que soit le produit utilisé, toujours faire un essai sur une petite surface avant de poursuivre.

- X - (aspirateur seulement)

Pour éliminer l'accumulation de poussière et de saleté, nettoyez ce tissu seulement avec un aspirateur ou une brosse souple. Les nettoyants mousse à base d'eau ou les produits solvants de tout type peuvent causer un rétrécissement excessif des fibres du tissu, la formation de taches ou l'agglomération du fini velours du matériel et ne devraient pas être utilisés.

- D - (nettoyage à sec seulement)

Cuidado de productos tapizados en tela Códigos de limpieza

Los códigos de limpieza de telas determinan los métodos mejores y menos costosos de limpieza doméstica para sus muebles. Debido a las diversas formas en que los muebles pueden ser manchados o dañados, no hay garantía de que los resultados serán completamente exitosos. Utilice los métodos sugeridos a su propia discreción. Preprueba siempre en un área pequeña antes de continuar. Para evitar que el suelo en general del polvo y la suciedad, se recomienda la aspiración frecuente o cepillado ligero. Utilice un servicio de limpieza profesional cuando se haya alcanzado una condición general sucia.

- W - water based Cleaner

Limpie el lugar con la espuma solo de un agente de limpieza a base de agua, como un detergente suave o un producto de champú para tapicería no solvente. Aplique espuma con un cepillo suave en un movimiento circular. aspire cuando esté seco.

- S - limpiador de disolventes

Limpie el lugar con un disolvente suave sin agua o con un producto de limpieza en seco. Limpie solo en una habitación bien ventilada y evite cualquier producto que contenga tetracloruro de carbono u

otros materiales tóxicos.

- WS – limpiador de agua/disolvente

Limpie con un disolvente suave, un champú de tapicería o la espuma de un detergente suave. Cuando utilice un producto disolvente o de limpieza en seco, siga las instrucciones cuidadosamente y límpielas solo en una habitación bien ventilada. Evite cualquier producto que contenga tetracloruro de carbono u otros materiales tóxicos. Con cualquiera de los dos métodos, pruebe un área pequeña antes de continuar.

- X – solo vacío

Limpie este tejido solo con la aspiradora o el cepillado ligero para evitar la acumulación de polvo y suciedad. Los limpiadores de espuma a base de agua o los detergentes a base de disolventes de cualquier tipo pueden causar una contracción excesiva, manchas o distorsión de la pila superficial y, por lo tanto, no deben utilizarse.

- D – limpieza en seco solo

ASSEMBLY INSTRUCTIONS INSTRUCTIONS DE MONTAGE INSTRUCCIONES DE MONTAJE

DRAWER NIGHTSTAND





CAUTION: PLEASE READ ALL INSTRUCTIONS BEFORE STARTING THE ASSEMBLY OF THIS PRODUCT. THESE PIECES ARE HEAVY. IN ORDER TO PREVENT PERSONAL INJURY AND ENSURE THAT THIS PRODUCT IS NOT DAMAGED DURING THE ASSEMBLY PROCESS, IT IS STRONGLY RECOMMENDED TO ENLIST THE ASSISTANCE OF ONE OR MORE PERSONS. IN CASE OF EXCESS STAIN, WIPE THE BOTTOM OF THE UNIT BEFORE PLACING ON ANY SURFACE.

ATTENTION: VEUILLEZ LIRE TOUTES LES INSTRUCTIONS AVANT DE COMMENCER L'ASSEMBLAGE DE CE PRODUIT. LES PIECES SONT LOURDES. POUR EVITER TOUTE BLESSURE ET POUR VOUS ASSURER QUE LE PRODUIT N'EST PAS ENDOMMAGE' PENDANT L'ASSEMBLAGE, NOUS VOUS RECOMMANDONS DE FAIRE APPEL A UNE OU PLUSIEURS AUTRES PERSONNES. EN CAS DE TACHE EXCESSIVE, ESSUYEZ LE FOND DE L'UNITE' AVANT LE PLACEMENT SUR N'IMPORTE QUELLE SURFACE.



CUIDADO: FAVOR DE LEER TODAS LAS INSTRUCCIONES ANTES DE ENSAMBLAR SU PRODUCTO, ESTAS. PIEZAS SON PESADAS. PARA PREVENIR HERIDAS PERSONALES Y ASEGURAR QUE SU PRODUCTO NO SEA DAN ADO MIENTRAS ES ENSAMBLADO. SE RECOMIENDA LA ASISTENCIA DE UNA O MAUS PERSONAS.

WARNING: PROTECTIVE GLIDE IS PLACED UNDER EACH LEG OF THE FURNITURE TO RESIST SCRATCHES ON FLOOR SURFACE. SOME FLOOR SURFACES CAN BE EXTRA SENSITIVE TO SCRATCHES AND MARKINGS, IF YOU ARE NOT SURE CONSULT WITH YOUR DEALER. AVERTISSEMENT. LES PIEDS DES MEUBLES SONT MUNIS DE PATINS DESTINES A PROTEGER LE PLANCHER. CERTAINS REVETEMENTS DE SOL PEUVENT ETRE TRES FRAGILES. EN CAS DE DOUTE. CONSULTER LE MARCHAND.

LIST OF PARTS AND HARDWARE/ LISTE DES PIÈCES ET DU MATÉRIEL/ LISTA DE PIEZAS Y HARDWARE

NO#/ NOMBRE/ NÚMERO	DESCRIPTION/ DESCRIPTION/ DESCRIPCIÓN		QUANTITY/ QUANTITÉ/ CANTIDAD
A	Flat washer / Rondelle plate / Arandela plana	Ø1/4"x19mm	 4PCS
B	Lock washer / Rondelle de blocage / Arandela de bloqueo	Ø1/4"x11mm	 4PCS
C	Bolt / Boulon / Tornillo	Ø1/4"x2 3/4"L	 4PCS
D	Wrench / Clé / Llave inglesa	10mm	 1PC
E	Tilt kit bracket / Support de trousse d'inclinaison / Kit de soporte de inclinación		 1PC

LIST OF PARTS AND HARDWARE/ LISTE DES PIÈCES ET DU MATÉRIEL/ LISTA DE PIEZAS Y HARDWARE

NO#/ NOMBRE/ NÚMERO	DESCRIPTION/ DESCRIPTION/ DESCRIPCIÓN		QUANTITY/ QUANTITÉ/ CANTIDAD
1	DRAWER NIGHTSTAND		1PC
2	Foot / Façade Pied / frente Pie		4PCS

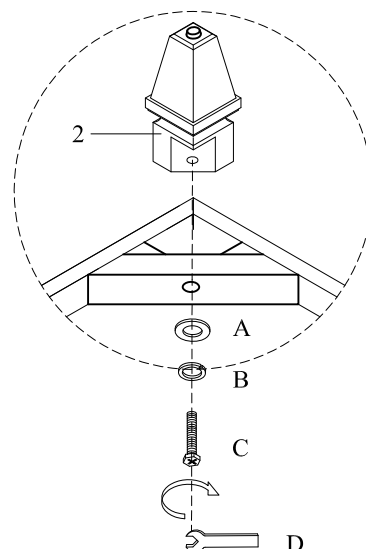
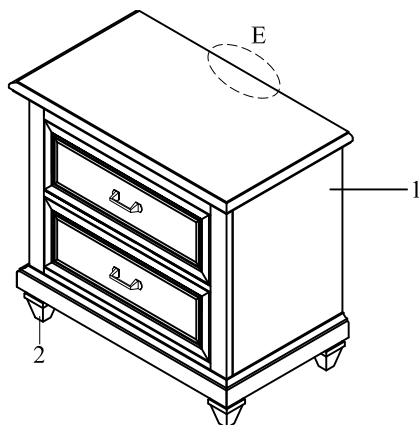

NOTE:
ASSEMBLE UNIT ON A SOFT SURFACE.
ASSEMBLEZ L'UNITÉ SUR UNE SURFACE MOLLE.
ENSAMBLE LA UNIDAD EN UNA SUPERFICIE PLANA Y SUAVE.

DO NOT TIGHTEN BOLTS UNTIL THE UNIT IS COHMPLETELY ASSEMBLED.
NE SERREZ PAS LES BOULONS JUSQU'À CE QUE L'UNITÉ SOIT COHMPLÈTEMENT ASSEMBLÉE.
NO APRIETE LOS TORNILLOS HASTA QUE LA UNIDAD ESTE COHMPLETAMENTE ENSAMBLADA.

ASSEMBLY INSTRUCTIONS

INSTRUCTIONS DE MONTAGE

INSTRUCCIONES DE MONTAJE

DRAWER CHEST





CAUTION: PLEASE READ ALL INSTRUCTIONS BEFORE STARTING THE ASSEMBLY OF THIS PRODUCT. THESE PIECES ARE HEAVY. IN ORDER TO PREVENT PERSONAL INJURY AND ENSURE THAT THIS PRODUCT IS NOT DAMAGED DURING THE ASSEMBLY PROCESS, IT IS STRONGLY RECOMMENDED TO ENLIST THE ASSISTANCE OF ONE OR MORE PERSONS. IN CASE OF EXCESS STAIN, WIPE THE BOTTOM OF THE UNIT BEFORE PLACING ON ANY SURFACE.

ATTENTION: VEUILLEZ LIRE TOUTES LES INSTRUCTIONS AVANT DE COMMENCER L'ASSEMBLAGE DE CE PRODUIT. LES PIECES SONT LOURDES. POUR EVITER TOUTE BLESSURE ET POUR VOUS ASSURER QUE LE PRODUIT N'EST PAS ENDOMMAGE' PENDANT L'ASSEMBLAGE, NOUS VOUS RECOMMANDONS DE FAIRE APPEL A UNE OU PLUSIEURS AUTRES PERSONNES. EN CAS DE TACHE EXCESSIVE, ESSUYEZ LE FOND DE L'UNITE' AVANT LE PLACEMENT SUR N'IMPORTE QUELLE SURFACE.



CUIDADO: FAVOR DE LEER TODAS LAS INSTRUCCIONES ANTES DE ENSAMBLAR SU PRODUCTO, ESTAS. PIEZAS SON PESADAS. PARA PREVENIR HERIDAS PERSONALES Y ASEGURAR QUE SU PRODUCTO NO SEA DAN ADO MIENTRAS ES ENSAMBLADO. SE RECOMIENDA LA ASISTENCIA DE UNA O MAUS PERSONAS.

WARNING: PROTECTIVE GLIDE IS PLACED UNDER EACH LEG OF THE FURNITURE TO RESIST SCRATCHES ON FLOOR SURFACE. SOME FLOOR SURFACES CAN BE EXTRA SENSITIVE TO SCRATCHES AND MARKINGS, IF YOU ARE NOT SURE CONSULT WITH YOUR DEALER. AVERTISSEMENT. LES PIEDS DES MEUBLES SONT MUNIS DE PATINS DESTINES A PROTEGER LE PLANCHER. CERTAINS REVETEMENTS DE SOL PEUVENT ETRE TRES FRAGILES. EN CAS DE DOUTE. CONSULTER LE MARCHAND.

LIST OF PARTS AND HARDWARE/ LISTE DES PIÈCES ET DU MATÉRIEL/ LISTA DE PIEZAS Y HARDWARE

NO#/ NOMBRE/ NÚMERO	DESCRIPTION/ DESCRIPTION/ DESCRIPCIÓN			QUANTITY/ QUANTITÉ/ CANTIDAD
A	Flat washer / Rondelle plate / Arandela plana	Ø1/4"x19mm		4PCS
B	Lock washer / Rondelle de blocage / Arandela de bloqueo	Ø1/4"x11mm		4PCS
C	Bolt / Boulon / Tornillo	Ø1/4"x2 3/4"L		4PCS
D	Wrench / Clé / Llave inglesa	10mm		1PC
E	Tilt kit bracket / Support de trousse d'inclinaison / Kit de soporte de inclinación			1PC

LIST OF PARTS AND HARDWARE/ LISTE DES PIÈCES ET DU MATÉRIEL/ LISTA DE PIEZAS Y HARDWARE

NO#/ NOMBRE/ NÚMERO	DESCRIPTION/ DESCRIPTION/ DESCRIPCIÓN			QUANTITY/ QUANTITÉ/ CANTIDAD
1	DRAWER CHEST			1PC
2	Foot / Façade Pied / frente Pie			4PCS

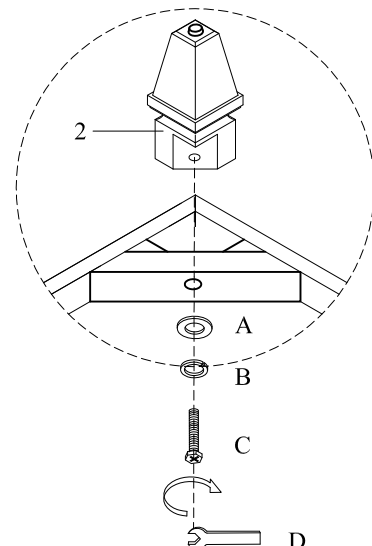
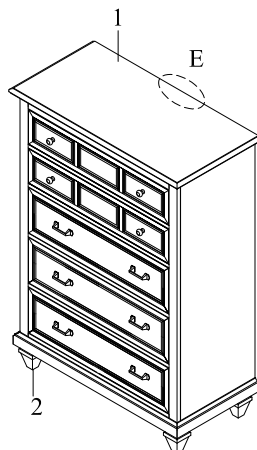

NOTE:
ASSEMBLE UNIT ON A SOFT SURFACE.
ASSEMBLEZ L'UNITÉ SUR UNE SURFACE MOLLE.
ENSAMBLE LA UNIDAD EN UNA SUPERFICIE PLANA Y SUAVE.

DO NOT TIGHTEN BOLTS UNTIL THE UNIT IS COHMPLETELY ASSEMBLED.
NE SERREZ PAS LES BOULONS JUSQU'À CE QUE L'UNITÉ SOIT COHMPLÈTEMENT ASSEMBLÉE.
NO APRIETE LOS TORNILLOS HASTA QUE LA UNIDAD ESTE COHMPLETAMENTE ENSAMBLADA.

ASSEMBLY INSTRUCTIONS INSTRUCTIONS DE MONTAGE INSTRUCCIONES DE MONTAJE





DRAWER DRESSER



CAUTION: PLEASE READ ALL INSTRUCTIONS BEFORE STARTING THE ASSEMBLY OF THIS PRODUCT. THESE PIECES ARE HEAVY. IN ORDER TO PREVENT PERSONAL INJURY AND ENSURE THAT THIS PRODUCT IS NOT DAMAGED DURING THE ASSEMBLY PROCESS, IT IS STRONGLY RECOMMENDED TO ENLIST THE ASSISTANCE OF ONE OR MORE PERSONS. IN CASE OF EXCESS STAIN, WIPE THE BOTTOM OF THE UNIT BEFORE PLACING ON ANY SURFACE.

ATTENTION: VEUILLEZ LIRE TOUTES LES INSTRUCTIONS AVANT DE COMMENCER L'ASSEMBLAGE DE CE PRODUIT. LES PIECES SONT LOURDES. POUR EVITER TOUTE BLESSURE ET POUR VOUS ASSURER QUE LE PRODUIT N'EST PAS ENDOMMAGE' PENDANT L'ASSEMBLAGE, NOUS VOUS RECOMMANDONS DE FAIRE APPEL A UNE OU PLUSIEURS AUTRES PERSONNES. EN CAS DE TACHE EXCESSIVE, ESSUYEZ LE FOND DE L'UNITE' AVANT LE PLACEMENT SUR N'IMPORTE QUELLE SURFACE.

CUIDADO: FAVOR DE LEER TODAS LAS INSTRUCCIONES ANTES DE ENSAMBLAR SU PRODUCTO, ESTAS. PIEZAS SON PESADAS. PARA PREVENIR HERIDAS PERSONALES Y ASEGURAR QUE SU PRODUCTO NO SEA DAN ADO MIENTRAS ES ENSAMBLADO. SE RECOMIENDA LA ASISTENCIA DE UNA O MAUS PERSONAS.

WARNING: PROTECTIVE GLIDE IS PLACED UNDER EACH LEG OF THE FURNITURE TO RESIST SCRATCHES ON FLOOR SURFACE. SOME FLOOR SURFACES CAN BE EXTRA SENSITIVE TO SCRATCHES AND MARKINGS, IF YOU ARE NOT SURE CONSULT WITH YOUR DEALER. AVERTISSEMENT. LES PIEDS DES MEUBLES SONT MUNIS DE PATINS DESTINES A PROTEGER LE PLANCHER. CERTAINS REVETEMENTS DE SOL PEUVENT ETRE TRES FRAGILES. EN CAS DE DOUTE. CONSULTER LE MARCHAND.

LIST OF PARTS AND HARDWARE/ LISTE DES PIÈCES ET DU MATÉRIEL/ LISTA DE PIEZAS Y HARDWARE				
NO#/ NOMBRE/ NÚMERO	DESCRIPTION/ DESCRIPTION/ DESCRIPCIÓN			QUANTITY/ QUANTITÉ/ CANTIDAD
A	Flat washer / Rondelle plate / Arandela plana	Ø1/4"x19mm		4PCS
B	Lock washer / Rondelle de blocage / Arandela de bloqueo	Ø1/4"x11mm		4PCS
C	Bolt / Boulon / Tornillo	Ø1/4"x2 3/4"L		4PCS
D	Wrench / Clé / Llave inglesa	10mm		1PC
E	Tilt kit bracket / Support de trousse d'inclinaison / Kit de soporte de inclinación			1PC

LIST OF PARTS AND HARDWARE/ LISTE DES PIÈCES ET DU MATÉRIEL/ LISTA DE PIEZAS Y HARDWARE				
NO#/ NOMBRE/ NÚMERO	DESCRIPTION/ DESCRIPTION/ DESCRIPCIÓN			QUANTITY/ QUANTITÉ/ CANTIDAD
1	DRAWER DRESSER			1PC
2	Foot / Pied / Pie			4PCS
3	SUPPORT LEG/ JAMBE D'APPUI PIERNA DE APOYO		 121x38x38mm	2PCS

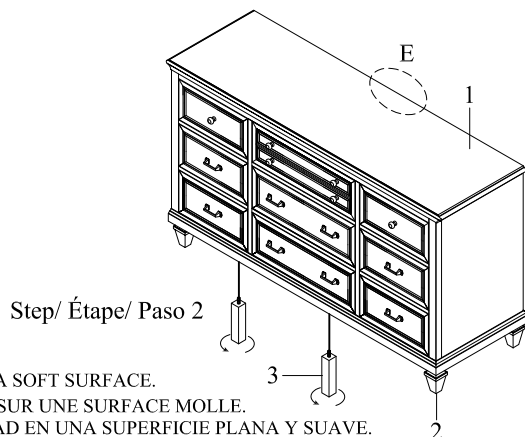

NOTE:
ASSEMBLE UNIT ON A SOFT SURFACE.
ASSEMBLEZ L'UNITÉ SUR UNE SURFACE MOLLE.
ENSAMBLE LA UNIDAD EN UNA SUPERFICIE PLANA Y SUAVE.

DO NOT TIGHTEN BOLTS UNTIL THE UNIT IS COHMPLETELY ASSEMBLED.
NE SERREZ PAS LES BOULONS JUSQU'À CE QUE L'UNITÉ SOIT COHMPLÈTEMENT ASSEMBLÉE.
NO APRIETE LOS TORNILLOS HASTA QUE LA UNIDAD ESTE COHMPLETAMENTE ENSAMBLADA.

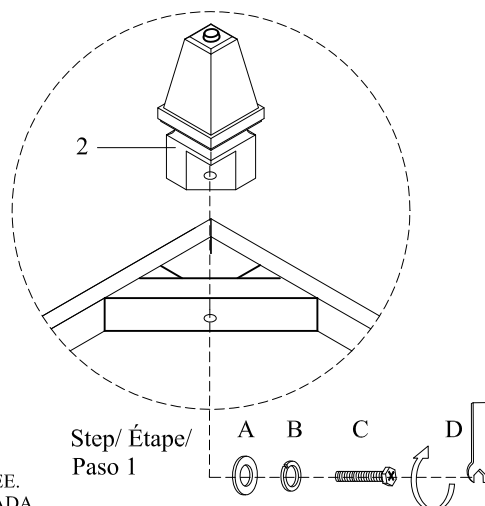

A B C D

ASSEMBLY INSTRUCTIONS INSTRUCTIONS DE MONTAGE INSTRUCCIONES DE MONTAJE

WARDROBE





CAUTION: PLEASE READ ALL INSTRUCTIONS BEFORE STARTING THE ASSEMBLY OF THIS PRODUCT. THESE PIECES ARE HEAVY. IN ORDER TO PREVENT PERSONAL INJURY AND ENSURE THAT THIS PRODUCT IS NOT DAMAGED DURING THE ASSEMBLY PROCESS, IT IS STRONGLY RECOMMENDED TO ENLIST THE ASSISTANCE OF ONE OR MORE PERSONS. IN CASE OF EXCESS STAIN, WIPE THE BOTTOM OF THE UNIT BEFORE PLACING ON ANY SURFACE.

ATTENTION: VEUILLEZ LIRE TOUTES LES INSTRUCTIONS AVANT DE COMMENCER L'ASSEMBLAGE DE CE PRODUIT. LES PIECES SONT LOURDES. POUR EVITER TOUTE BLESSURE ET POUR VOUS ASSURER QUE LE PRODUIT N'EST PAS ENDOMMAGE' PENDANT L'ASSEMBLAGE, NOUS VOUS RECOMMANDONS DE FAIRE APPEL A UNE OU PLUSIEURS AUTRES PERSONNES. EN CAS DE TACHE EXCESSIVE, ESSUYEZ LE FOND DE L'UNITE' AVANT LE PLACEMENT SUR N'IMPORTE QUELLE SURFACE.



CUIDADO: FAVOR DE LEER TODAS LAS INSTRUCCIONES ANTES DE ENSAMBLAR SU PRODUCTO, ESTAS. PIEZAS SON PESADAS. PARA PREVENIR HERIDAS PERSONALES Y ASEGURAR QUE SU PRODUCTO NO SEA DAN ADO MIENTRAS ES ENSAMBLADO. SE RECOMIENDA LA ASISTENCIA DE UNA O MAUS PERSONAS.

WARNING: PROTECTIVE GLIDE IS PLACED UNDER EACH LEG OF THE FURNITURE TO RESIST SCRATCHES ON FLOOR SURFACE. SOME FLOOR SURFACES CAN BE EXTRA SENSITIVE TO SCRATCHES AND MARKINGS, IF YOU ARE NOT SURE CONSULT WITH YOUR DEALER. AVERTISSEMENT. LES PIEDS DES MEUBLES SONT MUNIS DE PATINS DESTINES A PROTEGER LE PLANCHER. CERTAINS REVETEMENTS DE SOL PEUVENT ETRE TRES FRAGILES. EN CAS DE DOUTE. CONSULTER LE MARCHAND.

LIST OF PARTS AND HARDWARE/ LISTE DES PIÈCES ET DU MATÉRIEL/ LISTA DE PIEZAS Y HARDWARE

NO#/ NOMBRE/ NÚMERO	DESCRIPTION/ DESCRIPTION/ DESCRIPCIÓN		QUANTITY/ QUANTITÉ/ CANTIDAD
A	Flat washer / Rondelle plate / Arandela plana	Ø5/16"x19mm	 8PCS
B	Lock washer / Rondelle de blocage / Arandela de bloqueo	Ø5/16"x12mm	 8PCS
C	Bolt / Boulon / Tornillo	Ø5/16"-2 1/4"L	 8PCS
D	Wrench / Clé / Llave inglesa	12mm	 1PC
E	Tilt kit bracket / Support de trousse d'inclinaison / Kit de soporte de inclinación		 1PC

LIST OF PARTS AND HARDWARE/ LISTE DES PIÈCES ET DU MATÉRIEL/ LISTA DE PIEZAS Y HARDWARE

NO#/ NOMBRE/ NÚMERO	DESCRIPTION/ DESCRIPTION/ DESCRIPCIÓN		QUANTITY/ QUANTITÉ/ CANTIDAD
1	WARDROBE		1PC
2	Foot / Pied / Pie		4PCS

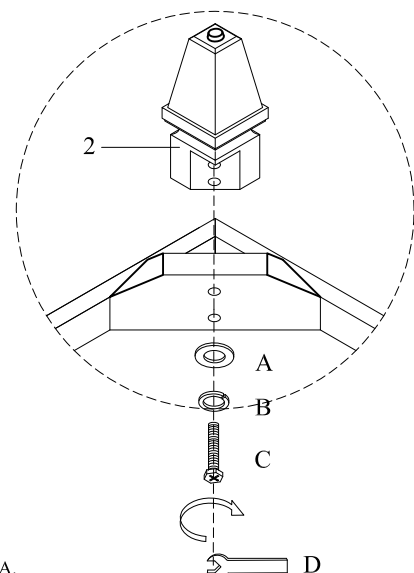
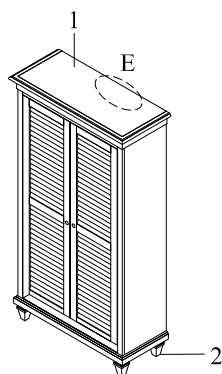

NOTE:
ASSEMBLE UNIT ON A SOFT SURFACE.
ASSEMBLEZ L'UNITÉ SUR UNE SURFACE MOLLE.
ENSAMBLE LA UNIDAD EN UNA SUPERFICIE PLANA Y SUAVE.

DO NOT TIGHTEN BOLTS UNTIL THE UNIT IS COHMPLETELY ASSEMBLED.
NE SERREZ PAS LES BOULONS JUSQU'À CE QUE L'UNITÉ SOIT COHMPLÈTEMENT ASSEMBLÉE.
NO APRIETE LOS TORNILLOS HASTA QUE LA UNIDAD ESTE COHMPLETAMENTE ENSAMBLADA.

ASSEMBLY INSTRUCTIONS INSTRUCTIONS DE MONTAGE INSTRUCCIONES DE MONTAJE





GENTLEMAN'S CHEST





CAUTION: PLEASE READ ALL INSTRUCTIONS BEFORE STARTING THE ASSEMBLY OF THIS PRODUCT. THESE PIECES ARE HEAVY. IN ORDER TO PREVENT PERSONAL INJURY AND ENSURE THAT THIS PRODUCT IS NOT DAMAGED DURING THE ASSEMBLY PROCESS, IT IS STRONGLY RECOMMENDED TO ENLIST THE ASSISTANCE OF ONE OR MORE PERSONS. IN CASE OF EXCESS STAIN, WIPE THE BOTTOM OF THE UNIT BEFORE PLACING ON ANY SURFACE.

ATTENTION: VEUILLEZ LIRE TOUTES LES INSTRUCTIONS AVANT DE COMMENCER L'ASSEMBLAGE DE CE PRODUIT. LES PIECES SONT LOURDES. POUR EVITER TOUTE BLESSURE ET POUR VOUS ASSURER QUE LE PRODUIT N'EST PAS ENDOMMAGE' PENDANT L'ASSEMBLAGE, NOUS VOUS RECOMMANDONS DE FAIRE APPEL A UNE OU PLUSIEURS AUTRES PERSONNES. EN CAS DE TACHE EXCESSIVE, ESSUYEZ LE FOND DE L'UNITE' AVANT LE PLACEMENT SUR N'IMPORTE QUELLE SURFACE.

CUIDADO: FAVOR DE LEER TODAS LAS INSTRUCCIONES ANTES DE ENSAMBLAR SU PRODUCTO, ESTAS. PIEZAS SON PESADAS. PARA PREVENIR HERIDAS PERSONALES Y ASEGURAR QUE SU PRODUCTO NO SEA DAN ADO MIENTRAS ES ENSAMBLADO. SE RECOMIENDA LA ASISTENCIA DE UNA O MAUS PERSONAS.

WARNING: PROTECTIVE GLIDE IS PLACED UNDER EACH LEG OF THE FURNITURE TO RESIST SCRATCHES ON FLOOR SURFACE. SOME FLOOR SURFACES CAN BE EXTRA SENSITIVE TO SCRATCHES AND MARKINGS, IF YOU ARE NOT SURE CONSULT WITH YOUR DEALER. AVERTISSEMENT. LES PIEDS DES MEUBLES SONT MUNIS DE PATINS DESTINES A PROTEGER LE PLANCHER. CERTAINS REVETEMENTS DE SOL PEUVENT ETRE TRES FRAGILES. EN CAS DE DOUTE. CONSULTER LE MARCHAND.

LIST OF PARTS AND HARDWARE/ LISTE DES PIÈCES ET DU MATÉRIEL/ LISTA DE PIEZAS Y HARDWARE				
NO#/ NOMBRE/ NÚMERO	DESCRIPTION/ DESCRIPTION/ DESCRIPCIÓN			QUANTITY/ QUANTITÉ/ CANTIDAD
A	Flat washer / Rondelle plate / Arandela plana	Ø5/16"x19mm		8PCS
B	Lock washer / Rondelle de blocage / Arandela de bloqueo	Ø5/16"x12mm		8PCS
C	Bolt / Boulon / Tornillo	Ø5/16"-2 1/4"L		8PCS
D	Wrench / Clé / Llave inglesa	12mm		1PC
E	Tilt kit bracket / Support de trousse d'inclinaison / Kit de soporte de inclinación			1PC
F	Felt pad	Ø5/8"x1/8"		4PCS

LIST OF PARTS AND HARDWARE/ LISTE DES PIÈCES ET DU MATÉRIEL/ LISTA DE PIEZAS Y HARDWARE				
NO#/ NOMBRE/ NÚMERO	DESCRIPTION/ DESCRIPTION/ DESCRIPCIÓN			QUANTITY/ QUANTITÉ/ CANTIDAD
1	GENTLEMAN'S CHEST			1PC
2	Foot / Pied / Pie			4PCS
3	Sliding door / Porte coulissante / puerta corrediza			1PC
4	Support Leg / Jambe d'appui / pierna de apoyo		 138x38x38mm	1PC

NOTE:
ASSEMBLE UNIT ON A SOFT SURFACE.
ASSEMBLEZ L'UNITÉ SUR UNE SURFACE MOLLE.
ENSAMBLE LA UNIDAD EN UNA SUPERFICIE PLANA Y SUAVE.

DO NOT TIGHTEN BOLTS UNTIL THE UNIT IS COHMPLETELY ASSEMBLED.
NE SERREZ PAS LES BOULONS JUSQU'À CE QUE L'UNITÉ SOIT COHMPLÈTEMENT ASSEMBLÉE.
NO APRIETE LOS TORNILLOS HASTA QUE LA UNIDAD ESTE COHMPLETAMENTE ENSAMBLADA.

ASSEMBLY INSTRUCTIONS INSTRUCTIONS DE MONTAGE INSTRUCCIONES DE MONTAJE

GENTLEMAN'S CHEST

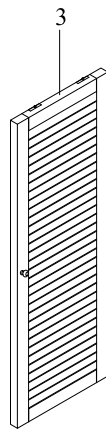
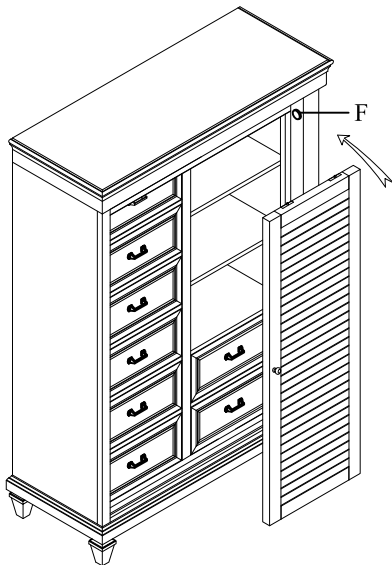
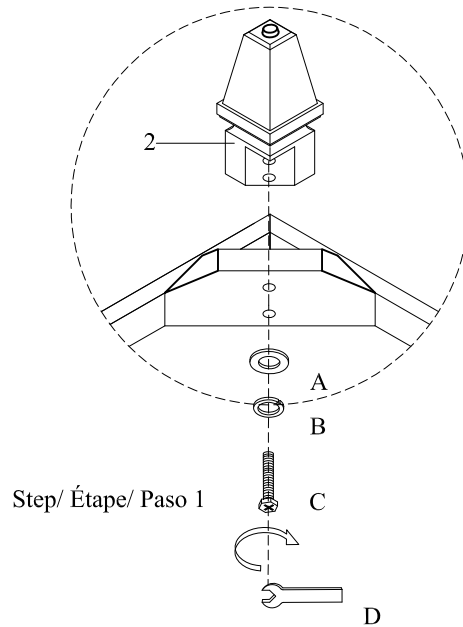
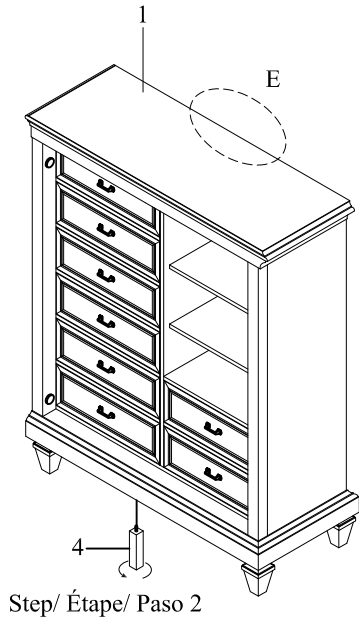

Step/ Étape/ Paso 3

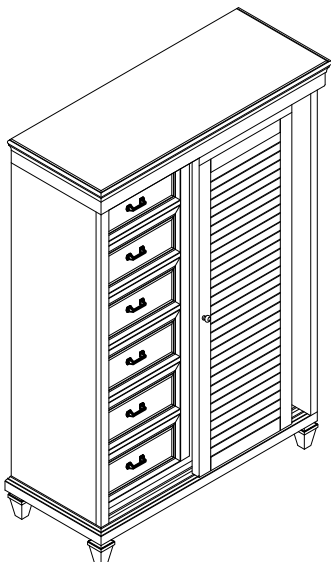
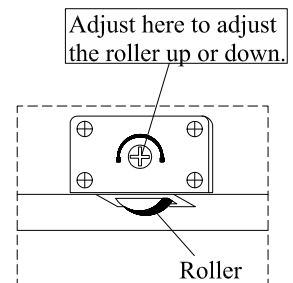
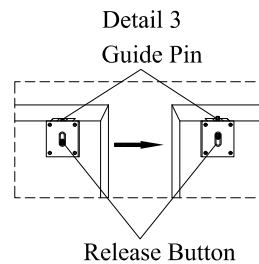

Install the door (if necessary):

Push the guide pins down so they are inside the door. Place the roller on the metal track so the door rolls smoothly. Place the top of the door underneath the track so when you push the release button (Detail 3) the pins go up in to the track.

Remove the door (if necessary):

Push the guide pins down so they are inside the door, and take the door off.

ASSEMBLY INSTRUCTIONS INSTRUCTIONS DE MONTAGE INSTRUCCIONES DE MONTAJE

MEDIA CHEST





CAUTION: PLEASE READ ALL INSTRUCTIONS BEFORE STARTING THE ASSEMBLY OF THIS PRODUCT. THESE PIECES ARE HEAVY. IN ORDER TO PREVENT PERSONAL INJURY AND ENSURE THAT THIS PRODUCT IS NOT DAMAGED DURING THE ASSEMBLY PROCESS, IT IS STRONGLY RECOMMENDED TO ENLIST THE ASSISTANCE OF ONE OR MORE PERSONS. IN CASE OF EXCESS STAIN, WIPE THE BOTTOM OF THE UNIT BEFORE PLACING ON ANY SURFACE.

ATTENTION: VEUILLEZ LIRE TOUTES LES INSTRUCTIONS AVANT DE COMMENCER L'ASSEMBLAGE DE CE PRODUIT. LES PIECES SONT LOURDES. POUR EVITER TOUTE BLESSURE ET POUR VOUS ASSURER QUE LE PRODUIT N'EST PAS ENDOMMAGE' PENDANT L'ASSEMBLAGE, NOUS VOUS RECOMMANDONS DE FAIRE APPEL A UNE OU PLUSIEURS AUTRES PERSONNES. EN CAS DE TACHE EXCESSIVE, ESSUYEZ LE FOND DE L'UNITE' AVANT LE PLACEMENT SUR N'IMPORTE QUELLE SURFACE.



CUIDADO: FAVOR DE LEER TODAS LAS INSTRUCCIONES ANTES DE ENSAMBLAR SU PRODUCTO, ESTAS. PIEZAS SON PESADAS. PARA PREVENIR HERIDAS PERSONALES Y ASEGURAR QUE SU PRODUCTO NO SEA DAN ADO MIENTRAS ES ENSAMBLADO. SE RECOMIENDA LA ASISTENCIA DE UNA O MAUS PERSONAS.

WARNING: PROTECTIVE GLIDE IS PLACED UNDER EACH LEG OF THE FURNITURE TO RESIST SCRATCHES ON FLOOR SURFACE. SOME FLOOR SURFACES CAN BE EXTRA SENSITIVE TO SCRATCHES AND MARKINGS, IF YOU ARE NOT SURE CONSULT WITH YOUR DEALER. AVERTISSEMENT. LES PIEDS DES MEUBLES SONT MUNIS DE PATINS DESTINES A PROTEGER LE PLANCHER. CERTAINS REVETEMENTS DE SOL PEUVENT ETRE TRES FRAGILES. EN CAS DE DOUTE. CONSULTER LE MARCHAND.

LIST OF PARTS AND HARDWARE/ LISTE DES PIÈCES ET DU MATÉRIEL/ LISTA DE PIEZAS Y HARDWARE

NO#/ NOMBRE/ NÚMERO	DESCRIPTION/ DESCRIPTION/ DESCRIPCIÓN		QUANTITY/ QUANTITÉ/ CANTIDAD
A	Flat washer/ Rondelle plate/ Arandela plana	Ø1/4"x19mm	 4PCS
B	Lock washer/ Rondelle de blocage/ Arandela de bloqueo	Ø1/4"x11mm	 4PCS
C	Bolt/ Boulon/ Tornillo	Ø1/4"x2 3/4"L	 4PCS
D	Wrench / Clé / Llave inglesa	10mm	 1PC
E	Tilt kit bracket/ Support de trousse d'inclinaison/ Kit de soporte de inclinación		 1PC

LIST OF PARTS AND HARDWARE/ LISTE DES PIÈCES ET DU MATÉRIEL/ LISTA DE PIEZAS Y HARDWARE

NO#/ NOMBRE/ NÚMERO	DESCRIPTION/ DESCRIPTION/ DESCRIPCIÓN		QUANTITY/ QUANTITÉ/ CANTIDAD
1	MEDIA CHEST		1PC
2	Foot / Façade Pied / frente Pie		4PCS

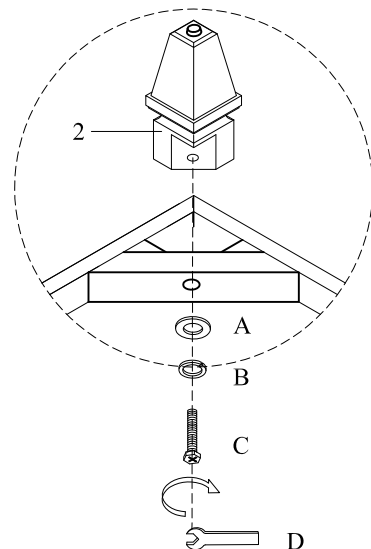
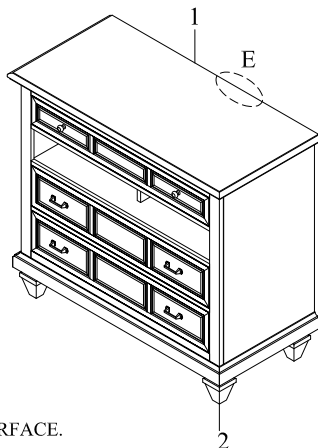

NOTE:
ASSEMBLE UNIT ON A SOFT SURFACE.
ASSEMBLEZ L'UNITÉ SUR UNE SURFACE MOLLE.
ENSAMBLE LA UNIDAD EN UNA SUPERFICIE PLANA Y SUAVE.

DO NOT TIGHTEN BOLTS UNTIL THE UNIT IS COHMPLETELY ASSEMBLED.
NE SERREZ PAS LES BOULONS JUSQU'À CE QUE L'UNITÉ SOIT COHMPLÈTEMENT ASSEMBLÉE.
NO APRIETE LOS TORNILLOS HASTA QUE LA UNIDAD ESTE COHMPLETAMENTE ENSAMBLADA.

ASSEMBLY INSTRUCTIONS INSTRUCTIONS DE MONTAGE INSTRUCCIONES DE MONTAJE









KING SHUTTER PANEL BED HB
KING SHUTTER PANEL BED FB
QUEEN/KING SHUTTER PANEL BED RS

CAUTION: PLEASE READ ALL INSTRUCTIONS BEFORE STARTING THE ASSEMBLY OF THIS PRODUCT. THESE PIECES ARE HEAVY. IN ORDER TO PREVENT PERSONAL INJURY AND ENSURE THAT THIS PRODUCT IS NOT DAMAGED DURING THE ASSEMBLY PROCESS, IT IS STRONGLY RECOMMENDED TO ENLIST THE ASSISTANCE OF ONE OR MORE PERSONS. IN CASE OF EXCESS STAIN, WIPE THE BOTTOM OF THE UNIT BEFORE PLACING ON ANY SURFACE.

ATTENTION: VEUILLEZ LIRE TOUTES LES INSTRUCTIONS AVANT DE COMMENCER L'ASSEMBLAGE DE CE PRODUIT. LES PIECES SONT LOURDES. POUR EVITER TOUTE BLESSURE ET POUR VOUS ASSURER QUE LE PRODUIT N'EST PAS ENDOMMAGE' PENDANT L'ASSEMBLAGE, NOUS VOUS RECOMMANDONS DE FAIRE APPEL A UNE OU PLUSIEURS AUTRES PERSONNES. EN CAS DE TACHE EXCESSIVE, ESSUYEZ LE FOND DE L'UNITE' AVANT LE PLACEMENT SUR N'IMPORTE QUELLE SURFACE.

CUIDADO: FAVOR DE LEER TODAS LAS INSTRUCCIONES ANTES DE ENSAMBLAR SU PRODUCTO, ESTAS. PIEZAS SON PESADAS. PARA PREVENIR HERIDAS PERSONALES Y ASEGURAR QUE SU PRODUCTO NO SEA DAN ADO MIENTRAS ES ENSAMBLADO. SE RECOMIENDA LA ASISTENCIA DE UNA O MAUS PERSONAS.

WARNING: PROTECTIVE GLIDE IS PLACED UNDER EACH LEG OF THE FURNITURE TO RESIST SCRATCHES ON FLOOR SURFACE. SOME FLOOR SURFACES CAN BE EXTRA SENSITIVE TO SCRATCHES AND MARKINGS, IF YOU ARE NOT SURE CONSULT WITH YOUR DEALER. AVERTISSEMENT. LES PIEDS DES MEUBLES SONT MUNIS DE PATINS DESTINES A PROTEGER LE PLANCHER. CERTAINS REVETEMENTS DE SOL PEUVENT ETRE TRES FRAGILES. EN CAS DE DOUTE. CONSULTER LE MARCHAND.

LIST OF PARTS AND HARDWARE/ LISTE DES PIÈCES ET DU MATÉRIEL/ LISTA DE PIEZAS Y HARDWARE				
NO#/ NOMBRE/ NÚMERO	DESCRIPTION/ DESCRIPTION/ DESCRIPCIÓN			QUANTITY/ QUANTITÉ/ CANTIDAD
A	Bolt / Boulon / Tornillo	Ø5/16"x4 1/2"L		8PCS
B	Lock washer "C" / Rondelle de blocage "C" / Arandela de bloqueo "C"	Ø5/16"		8PCS
C	Nut / Écrou / Nuez	Ø5/16"		8PCS
D	Flat washer / Rondelle plate / Arandela plana	Ø5/16"x19mm		14PCS
E	Lock washer / Rondelle de blocage / Arandela de bloqueo	Ø5/16"x11mm		14PCS
F	Bolt / Boulon / Tornillo	Ø5/16"x2"L		10PCS
G	Bolt / Boulon / Tornillo	Ø5/16"x3 1/4"L		4PCS
H	Wrench / Clé / Llave inglesa	12mm		1PCS
I	Screw / Vis / tornillo de punta	M4-8x1"		8PCS

LIST OF PARTS AND HARDWARE/ LISTE DES PIÈCES ET DU MATÉRIEL/ LISTA DE PIEZAS Y HARDWARE			
NO#/ NOMBRE/ NÚMERO	DESCRIPTION/ DESCRIPTION/ DESCRIPCIÓN		QUANTITY/ QUANTITÉ/ CANTIDAD
1	KING SHUTTER PANEL BED HEADBOARD		1PC
2L	Left Leg / Patte gauche / Pierna izquierda		1PC
2R	Right Leg / Patte droite / Pierna derecha		1PC
3	Bottom Rail / Rail inférieur / Riel inferior		1PC
4	Mending plate / Plaque de réparation / Placa de reparación		2PCS
5	KING SHUTTER PANEL BED FOOTBOARD		1PC
6	QUEEN/KING SHUTTER PANEL BED RAILS		2PCS



NOTE:
ASSEMBLE UNIT ON A SOFT SURFACE.
ASSEMBLEZ L'UNITÉ SUR UNE SURFACE MOLLE.
ENSAMBLE LA UNIDAD EN UNA SUPERFICIE PLANA Y SUAVE.

DO NOT TIGHTEN BOLTS UNTIL THE UNIT IS COHMPLETELY ASSEMBLED.
NE SERREZ PAS LES BOULONS JUSQU'À CE QUE L'UNITÉ SOIT COHMPLÈTEMENT ASSEMBLÉE.
NO APRIETE LOS TORNILLOS HASTA QUE LA UNIDAD ESTE COHMPLETAMENTE ENSAMBLADA.

ASSEMBLY INSTRUCTIONS INSTRUCTIONS DE MONTAGE INSTRUCCIONES DE MONTAJE

KING SHUTTER PANEL BED HB
KING SHUTTER PANEL BED FB
QUEEN/KING SHUTTER PANEL BED RS

LIST OF PARTS AND HARDWARE/ LISTE DES PIÈCES ET DU MATÉRIEL/ LISTA DE PIEZAS Y HARDWARE

NO#/ NOMBRE/ NÚMERO	DESCRIPTION/ DESCRIPTION/ DESCRIPCIÓN		QUANTITY/ QUANTITÉ/ CANTIDAD
7	Slat / Latte / Listón	 1952x76x18mm	4PCS
8	Slat Support / Support de lattes / soporte de lamas	 221x34x34mm	12PCS

Note:

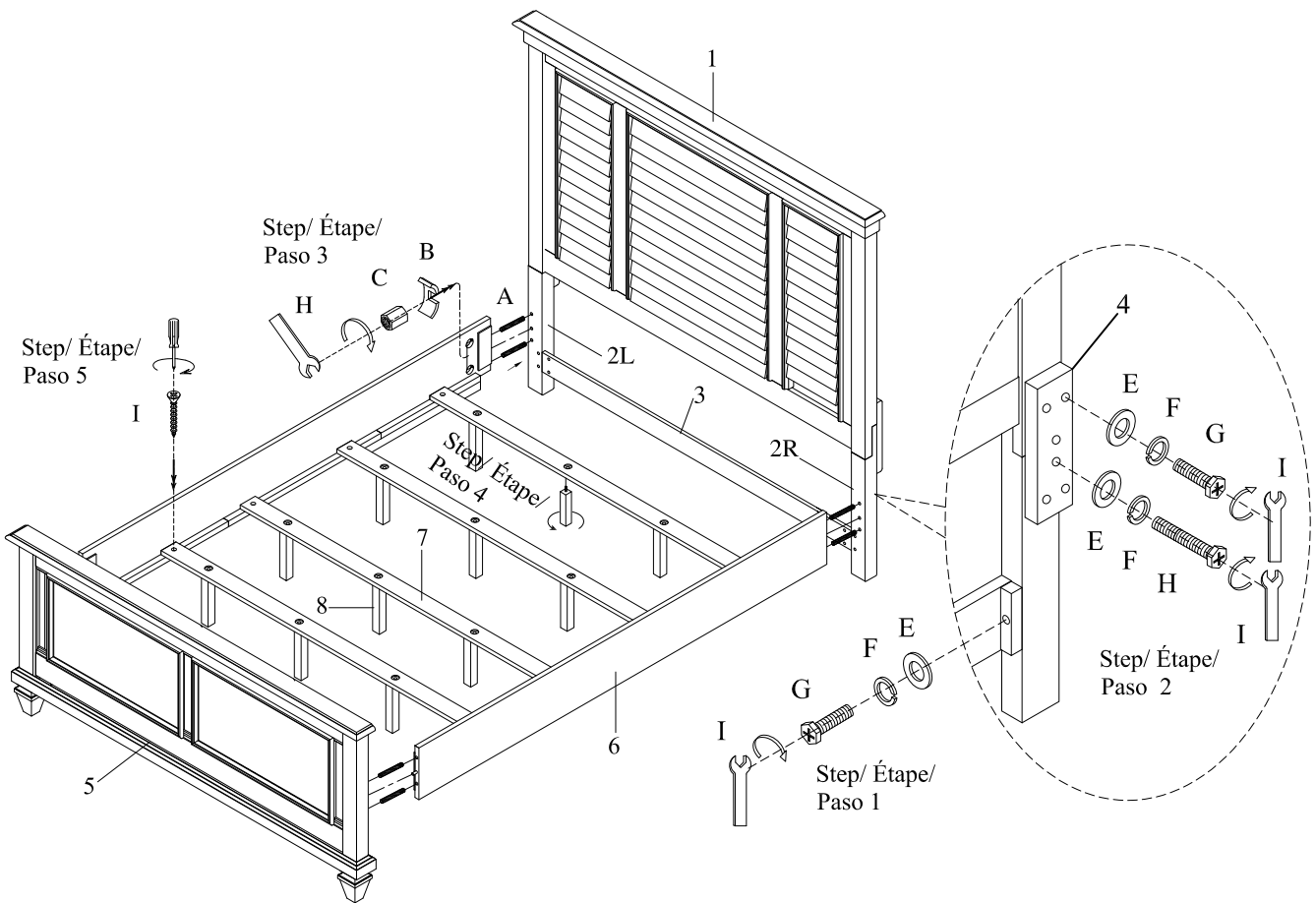
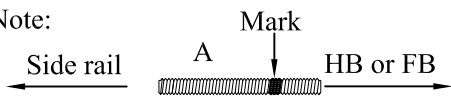

ASSEMBLY INSTRUCTIONS INSTRUCTIONS DE MONTAGE INSTRUCCIONES DE MONTAJE

QUEEN SHUTTER PANEL BED HB
QUEEN SHUTTER PANEL BED HB
QUEEN/KING SHUTTER PANEL BED RS









CAUTION: PLEASE READ ALL INSTRUCTIONS BEFORE STARTING THE ASSEMBLY OF THIS PRODUCT. THESE PIECES ARE HEAVY. IN ORDER TO PREVENT PERSONAL INJURY AND ENSURE THAT THIS PRODUCT IS NOT DAMAGED DURING THE ASSEMBLY PROCESS, IT IS STRONGLY RECOMMENDED TO ENLIST THE ASSISTANCE OF ONE OR MORE PERSONS. IN CASE OF EXCESS STAIN, WIPE THE BOTTOM OF THE UNIT BEFORE PLACING ON ANY SURFACE.

ATTENTION: VEUILLEZ LIRE TOUTES LES INSTRUCTIONS AVANT DE COMMENCER L'ASSEMBLAGE DE CE PRODUIT. LES PIECES SONT LOURDES. POUR EVITER TOUTE BLESSURE ET POUR VOUS ASSURER QUE LE PRODUIT N'EST PAS ENDOMMAGE' PENDANT L'ASSEMBLAGE, NOUS VOUS RECOMMANDONS DE FAIRE APPEL A UNE OU PLUSIEURS AUTRES PERSONNES. EN CAS DE TACHE EXCESSIVE, ESSUYEZ LE FOND DE L'UNITE' AVANT LE PLACEMENT SUR N'IMPORTE QUELLE SURFACE.







CAUIDADO: FAVOR DE LEER TODAS LAS INSTRUCCIONES ANTES DE ENSAMBLAR SU PRODUCTO, ESTAS. PIEZAS SON PESADAS. PARA PREVENIR HERIDAS PERSONALES Y ASEGURAR QUE SU PRODUCTO NO SEA DAN ADO MIENTRAS ES ENSAMBLADO. SE RECOMIENDA LA ASISTENCIA DE UNA O MAUS PERSONAS.

WARNING: PROTECTIVE GLIDE IS PLACED UNDER EACH LEG OF THE FURNITURE TO RESIST SCRATCHES ON FLOOR SURFACE. SOME FLOOR SURFACES CAN BE EXTRA SENSITIVE TO SCRATCHES AND MARKINGS, IF YOU ARE NOT SURE CONSULT WITH YOUR DEALER. AVERTISSEMENT. LES PIEDS DES MEUBLES SONT MUNIS DE PATINS DESTINES A PROTEGER LE PLANCHER. CERTAINS REVETEMENTS DE SOL PEUVENT ETRE TRES FRAGILES. EN CAS DE DOUTE. CONSULTER LE MARCHAND.

LIST OF PARTS AND HARDWARE/ LISTE DES PIÈCES ET DU MATÉRIEL/ LISTA DE PIEZAS Y HARDWARE

NO#/ NOMBRE/ NÚMERO	DESCRIPTION/ DESCRIPTION/ DESCRIPCIÓN		QUANTITY/ QUANTITÉ/ CANTIDAD
A	Bolt/ Boulon/ Tornillo	Ø5/16"x4 1/2"L	 8PCS
B	Lock washer "C" / Rondelle de blocage "C" / Arandela de bloqueo "C"	Ø5/16"	 8PCS
C	Nut/ Écrou /Nuez	Ø5/16"	 8PCS
D	Flat washer/ Rondelle plate/ Arandela plana	Ø5/16"x19mm	 14PCS
E	Lock washer/ Rondelle de blocage/ Arandela de bloqueo	Ø5/16"x11mm	 14PCS
F	Bolt/ Boulon/ Tornillo	Ø5/16"x2"L	 10PCS
G	Bolt/ Boulon/ Tornillo	Ø5/16"x3 1/4"L	 4PCS
H	Wrench / Clé/ Llave inglesa	12mm	 1PCS
I	Screw / Vis / tornillo de punta	M4-8x1"	 8PCS

LIST OF PARTS AND HARDWARE/ LISTE DES PIÈCES ET DU MATÉRIEL/ LISTA DE PIEZAS Y HARDWARE

NO#/ NOMBRE/ NÚMERO	DESCRIPTION/ DESCRIPTION/ DESCRIPCIÓN		QUANTITY/ QUANTITÉ/ CANTIDAD
1	QUEEN SHUTTER PANEL BED HEADBOARD		1PC
2L	Left Leg / Patte gauche / Pierna izquierda		1PC
2R	Right Leg / Patte droite / Pierna derecha		1PC
3	Bottom Rail / Rail inférieur / Riel inferior		1PC
4	Mending plate / Plaque de réparation / Placa de reparación		2PCS
5	QUEEN SHUTTER PANEL BED FOOTBOARD		1PC
6	QUEEN/KING SHUTTER PANEL BED RAILS		2PCS



NOTE:
ASSEMBLE UNIT ON A SOFT SURFACE.
ASSEMBLEZ L'UNITÉ SUR UNE SURFACE MOLLE.
ENSAMBLE LA UNIDAD EN UNA SUPERFICIE PLANA Y SUAVE.

DO NOT TIGHTEN BOLTS UNTIL THE UNIT IS COHMPLETELY ASSEMBLED.
NE SERREZ PAS LES BOULONS JUSQU'À CE QUE L'UNITÉ SOIT COHMPLÈTEMENT ASSEMBLÉE.
NO APRIETE LOS TORNILLOS HASTA QUE LA UNIDAD ESTE COHMPLETAMENTE ENSAMBLADA.

ASSEMBLY INSTRUCTIONS INSTRUCTIONS DE MONTAGE INSTRUCCIONES DE MONTAJE

QUEEN SHUTTER PANEL BED HB
QUEEN SHUTTER PANEL BED HB
QUEEN/KING SHUTTER PANEL BED RS

LIST OF PARTS AND HARDWARE/ LISTE DES PIÈCES ET DU MATÉRIEL/ LISTA DE PIEZAS Y HARDWARE

NO#/ NOMBRE/ NÚMERO	DESCRIPTION/ DESCRIPTION/ DESCRIPCIÓN		QUANTITY/ QUANTITÉ/ CANTIDAD
7	Slat / Latte / Listón		1545x76x18mm 4PCS
8	Slat Support / Support de lattes / soporte de lamas		221x34x34mm 4PCS

Note:

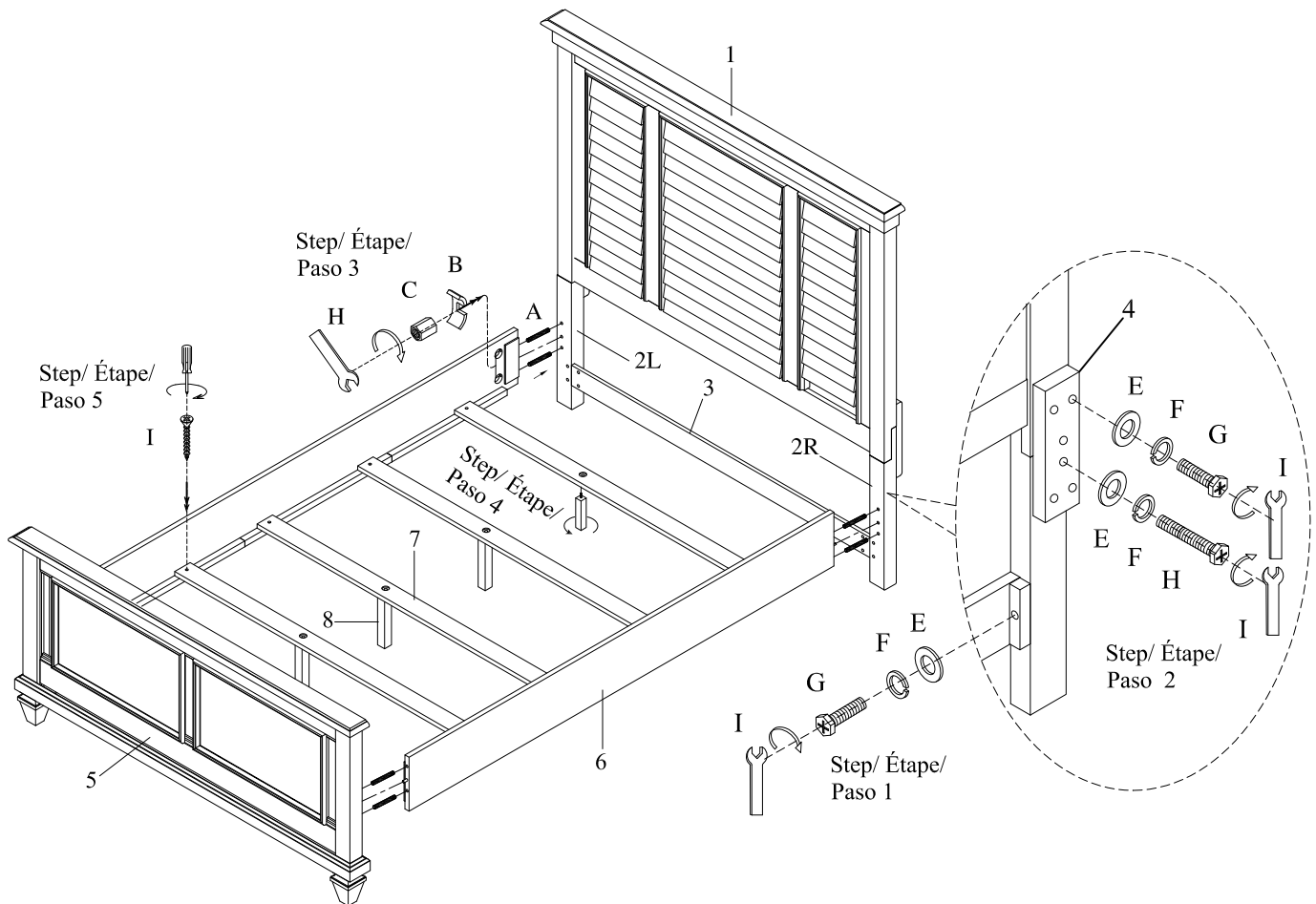
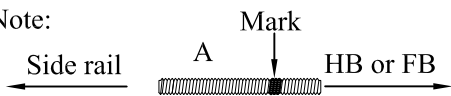

ASSEMBLY INSTRUCTIONS INSTRUCTIONS DE MONTAGE INSTRUCCIONES DE MONTAJE





DRAWER DRESSER MIRROR



CAUTION: PLEASE READ ALL INSTRUCTIONS BEFORE STARTING THE ASSEMBLY OF THIS PRODUCT. THESE PIECES ARE HEAVY. IN ORDER TO PREVENT PERSONAL INJURY AND ENSURE THAT THIS PRODUCT IS NOT DAMAGED DURING THE ASSEMBLY PROCESS, IT IS STRONGLY RECOMMENDED TO ENLIST THE ASSISTANCE OF ONE OR MORE PERSONS. IN CASE OF EXCESS STAIN, WIPE THE BOTTOM OF THE UNIT BEFORE PLACING ON ANY SURFACE.

ATTENTION: VEUILLEZ LIRE TOUTES LES INSTRUCTIONS AVANT DE COMMENCER L'ASSEMBLAGE DE CE PRODUIT. LES PIECES SONT LOURDES. POUR EVITER TOUTE BLESSURE ET POUR VOUS ASSURER QUE LE PRODUIT N'EST PAS ENDOMMAGE' PENDANT L'ASSEMBLAGE, NOUS VOUS RECOMMANDONS DE FAIRE APPEL A UNE OU PLUSIEURS AUTRES PERSONNES. EN CAS DE TACHE EXCESSIVE, ESSUYEZ LE FOND DE L'UNITE' AVANT LE PLACEMENT SUR N'IMPORTE QUELLE SURFACE.

CUIDADO: FAVOR DE LEER TODAS LAS INSTRUCCIONES ANTES DE ENSAMBLAR SU PRODUCTO, ESTAS. PIEZAS SON PESADAS. PARA PREVENIR HERIDAS PERSONALES Y ASEGURAR QUE SU PRODUCTO NO SEA DAN ADO MIENTRAS ES ENSAMBLADO. SE RECOMIENDA LA ASISTENCIA DE UNA O MAUS PERSONAS.

WARNING: PROTECTIVE GLIDE IS PLACED UNDER EACH LEG OF THE FURNITURE TO RESIST SCRATCHES ON FLOOR SURFACE. SOME FLOOR SURFACES CAN BE EXTRA SENSITIVE TO SCRATCHES AND MARKINGS, IF YOU ARE NOT SURE CONSULT WITH YOUR DEALER.
AVERTISSEMENT. LES PIEDS DES MEUBLES SONT MUNIS DE PATINS DESTINES A PROTEGER LE PLANCHER. CERTAINS REVETEMENTS DE SOL PEUVENT ETRE TRES FRAGILES. EN CAS DE DOUTE. CONSULTER LE MARCHAND.

LIST OF PARTS AND HARDWARE/ LISTE DES PIÈCES ET DU MATÉRIEL/ LISTA DE PIEZAS Y HARDWARE				
No#/ NOMBRE/ NÚMERO	DESCRIPTION/ DESCRIPTION/ DESCRIPCIÓN			QUANTITY/ QUANTITÉ/ CANTIDAD
A	Flat washer/ Rondelle plate/ Arandela plana	Ø1/4"x19mm		8PCS
B	Lock washer/ Rondelle de blocage/ Arandela de bloqueo	Ø1/4"x11mm		8PCS
C	Bolt/ Boulon/ Tornillo	Ø1/4"x2"L		8PCS
D	Allen Key / Clé Allen / Llave Allen	60mm		1PC

LIST OF PARTS AND HARDWARE/ LISTE DES PIÈCES ET DU MATÉRIEL/ LISTA DE PIEZAS Y HARDWARE				
No#/ NOMBRE/ NÚMERO	DESCRIPTION/ DESCRIPTION/ DESCRIPCIÓN			QUANTITY/ QUANTITÉ/ CANTIDAD
1	MIRROR			1PC
2	Mirror Support Rail / Rail de soutien du miroir / soporte para espejo			2PCS
3	DRAWER DRESSER			1PC

NOTE:
ASSEMBLE UNIT ON A SOFT SURFACE.
ASSEMBLEZ L'UNITÉ SUR UNE SURFACE MOLLE.
ENSAMBLE LA UNIDAD EN UNA SUPERFICIE PLANA Y SUAVE.

DO NOT TIGHTEN BOLTS UNTIL THE UNIT IS COHMPLETELY ASSEMBLED.
NE SERREZ PAS LES BOULONS JUSQU'À CE QUE L'UNITÉ SOIT COHMPLÈTEMENT ASSEMBLÉE.
NO APRIETE LOS TORNILLOS HASTA QUE LA UNIDAD ESTE COHMPLETAMENTE ENSAMBLADA.

ASSEMBLY INSTRUCTIONS
INSTRUCTIONS DE MONTAGE
INSTRUCCIONES DE MONTAJE

DRAWER DRESSER
MIRROR

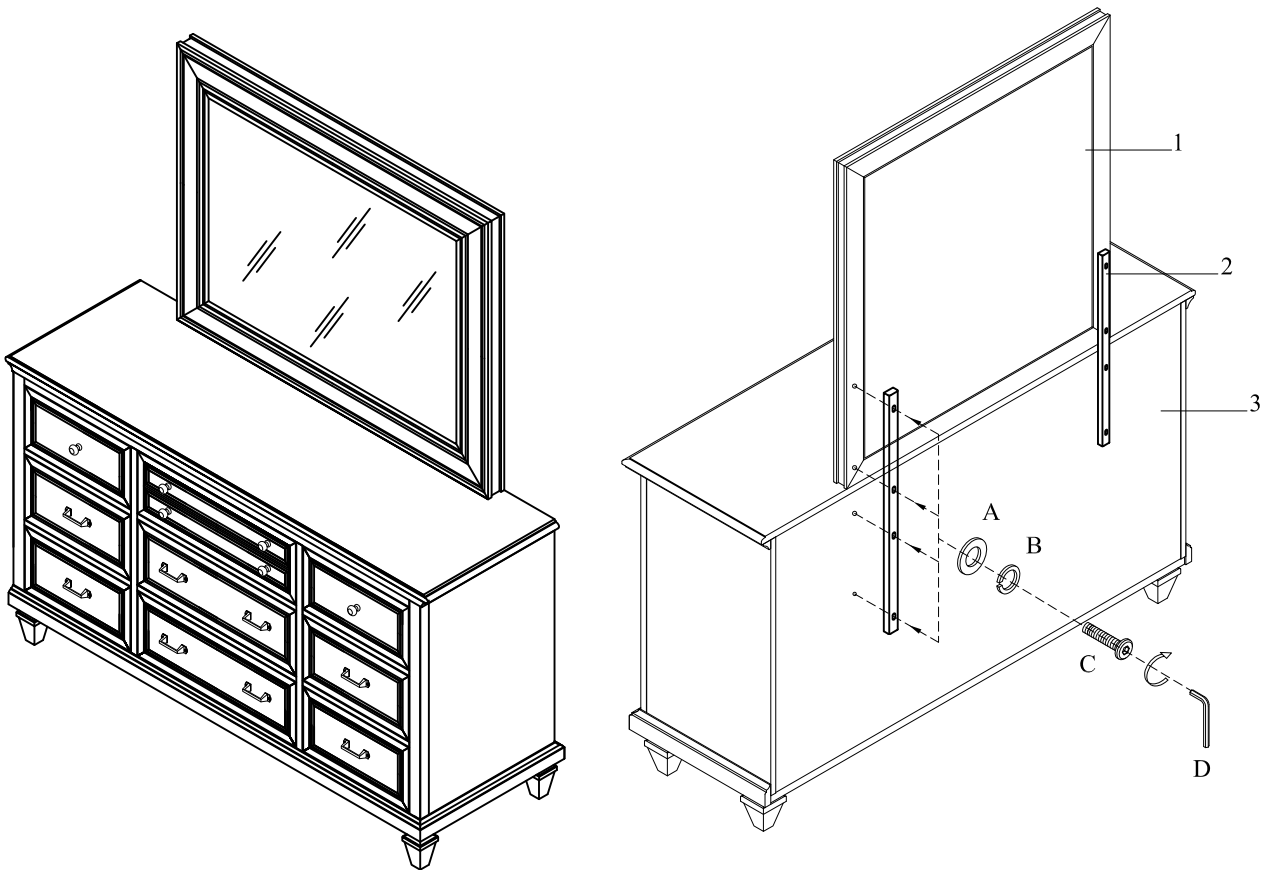

ASSEMBLY INSTRUCTIONS INSTRUCTIONS DE MONTAGE INSTRUCCIONES DE MONTAJE

QUEEN PANEL BED HEADBOARD
QUEEN PANEL BED FOOTBOARD
QUEEN/KING PANEL BED RAILS









CAUTION: PLEASE READ ALL INSTRUCTIONS BEFORE STARTING THE ASSEMBLY OF THIS PRODUCT. THESE PIECES ARE HEAVY. IN ORDER TO PREVENT PERSONAL INJURY AND ENSURE THAT THIS PRODUCT IS NOT DAMAGED DURING THE ASSEMBLY PROCESS, IT IS STRONGLY RECOMMENDED TO ENLIST THE ASSISTANCE OF ONE OR MORE PERSONS. IN CASE OF EXCESS STAIN, WIPE THE BOTTOM OF THE UNIT BEFORE PLACING ON ANY SURFACE.

ATTENTION: VEUILLEZ LIRE TOUTES LES INSTRUCTIONS AVANT DE COMMENCER L'ASSEMBLAGE DE CE PRODUIT. LES PIECES SONT LOURDES. POUR EVITER TOUTE BLESSURE ET POUR VOUS ASSURER QUE LE PRODUIT N'EST PAS ENDOMMAGE' PENDANT L'ASSEMBLAGE, NOUS VOUS RECOMMANDONS DE FAIRE APPEL A UNE OU PLUSIEURS AUTRES PERSONNES. EN CAS DE TACHE EXCESSIVE, ESSUYEZ LE FOND DE L'UNITE' AVANT LE PLACEMENT SUR N'IMPORTE QUELLE SURFACE.







CAUIDADO: FAVOR DE LEER TODAS LAS INSTRUCCIONES ANTES DE ENSAMBLAR SU PRODUCTO, ESTAS. PIEZAS SON PESADAS. PARA PREVENIR HERIDAS PERSONALES Y ASEGURAR QUE SU PRODUCTO NO SEA DAN ADO MIENTRAS ES ENSAMBLADO. SE RECOMIENDA LA ASISTENCIA DE UNA O MAUS PERSONAS.

WARNING: PROTECTIVE GLIDE IS PLACED UNDER EACH LEG OF THE FURNITURE TO RESIST SCRATCHES ON FLOOR SURFACE. SOME FLOOR SURFACES CAN BE EXTRA SENSITIVE TO SCRATCHES AND MARKINGS, IF YOU ARE NOT SURE CONSULT WITH YOUR DEALER. AVERTISSEMENT. LES PIEDS DES MEUBLES SONT MUNIS DE PATINS DESTINES A PROTEGER LE PLANCHER. CERTAINS REVETEMENTS DE SOL PEUVENT ETRE TRES FRAGILES. EN CAS DE DOUTE. CONSULTER LE MARCHAND.

LIST OF PARTS AND HARDWARE/ LISTE DES PIÈCES ET DU MATÉRIEL/ LISTA DE PIEZAS Y HARDWARE

NO#/ NOMBRE/ NÚMERO	DESCRIPTION/ DESCRIPTION/ DESCRIPCIÓN		QUANTITY/ QUANTITÉ/ CANTIDAD
A	Bolt/ Boulon/ Tornillo	Ø5/16"x4 1/2"L	 8PCS
B	Nut/ Écrou /Nuez	Ø5/16"	 8PCS
C	Lock washer "C" / Rondelle de blocage "C" / Arandela de bloqueo "C"	Ø5/16"	 8PCS
D	Screw / Vis / tornillo de punta	M4-8x1"	 8PCS
E	Flat washer/ Rondelle plate/ Arandela plana	Ø5/16"x19mm	 14PCS
F	Lock washer/ Rondelle de blocage/ Arandela de bloqueo	Ø5/16"x11mm	 14PCS
G	Bolt/ Boulon/ Tornillo	Ø5/16"x2"L	 10PCS
H	Bolt/ Boulon/ Tornillo	Ø5/16"x3 1/4"L	 4PCS
I	Wrench / Clé/ Llave inglesa	12mm	 1PC

LIST OF PARTS AND HARDWARE/ LISTE DES PIÈCES ET DU MATÉRIEL/ LISTA DE PIEZAS Y HARDWARE

NO#/ NOMBRE/ NÚMERO	DESCRIPTION/ DESCRIPTION/ DESCRIPCIÓN		QUANTITY/ QUANTITÉ/ CANTIDAD
1	QUEEN PANEL BED HEADBOARD		1PC
2L	Left Leg / Patte gauche / Pierna izquierda		1PC
2R	Right Leg / Patte droite / Pierna derecha		1PC
3	QUEEN PANEL BED FOOTBOARD		1PC
4	QUEEN/KING PANEL BED RAILS		2PCS
5	Slat / Latte / Listón	 1545x76x18mm	4PCS
6	Slat Support / Support de lattes / soporte de lamas	 221x34x34mm	4PCS



NOTE:
ASSEMBLE UNIT ON A SOFT SURFACE.
ASSEMBLEZ L'UNITÉ SUR UNE SURFACE MOLLE.
ENSAMBLE LA UNIDAD EN UNA SUPERFICIE PLANA Y SUAVE.

DO NOT TIGHTEN BOLTS UNTIL THE UNIT IS COHMPLETELY ASSEMBLED.
NE SERREZ PAS LES BOULONS JUSQU'À CE QUE L'UNITÉ SOIT COHMPLÈTEMENT ASSEMBLÉE.
NO APRIETE LOS TORNILLOS HASTA QUE LA UNIDAD ESTE COHMPLETAMENTE ENSAMBLADA.

ASSEMBLY INSTRUCTIONS INSTRUCTIONS DE MONTAGE INSTRUCCIONES DE MONTAJE

QUEEN PANEL BED HEADBOARD
QUEEN PANEL BED FOOTBOARD
QUEEN/KING PANEL BED RAILS

LIST OF PARTS AND HARDWARE/ LISTE DES PIÈCES ET DU MATÉRIEL/ LISTA DE PIEZAS Y HARDWARE

NO#/ NOMBRE/ NÚMERO	DESCRIPTION/ DESCRIPTION/ DESCRIPCIÓN		QUANTITY/ QUANTITÉ/ CANTIDAD
7	Bottom Rail / Rail inférieur / Riel inferior		1PC
8	Mending plate / Plaque de réparation / Placa de reparación		2PCS

Note:

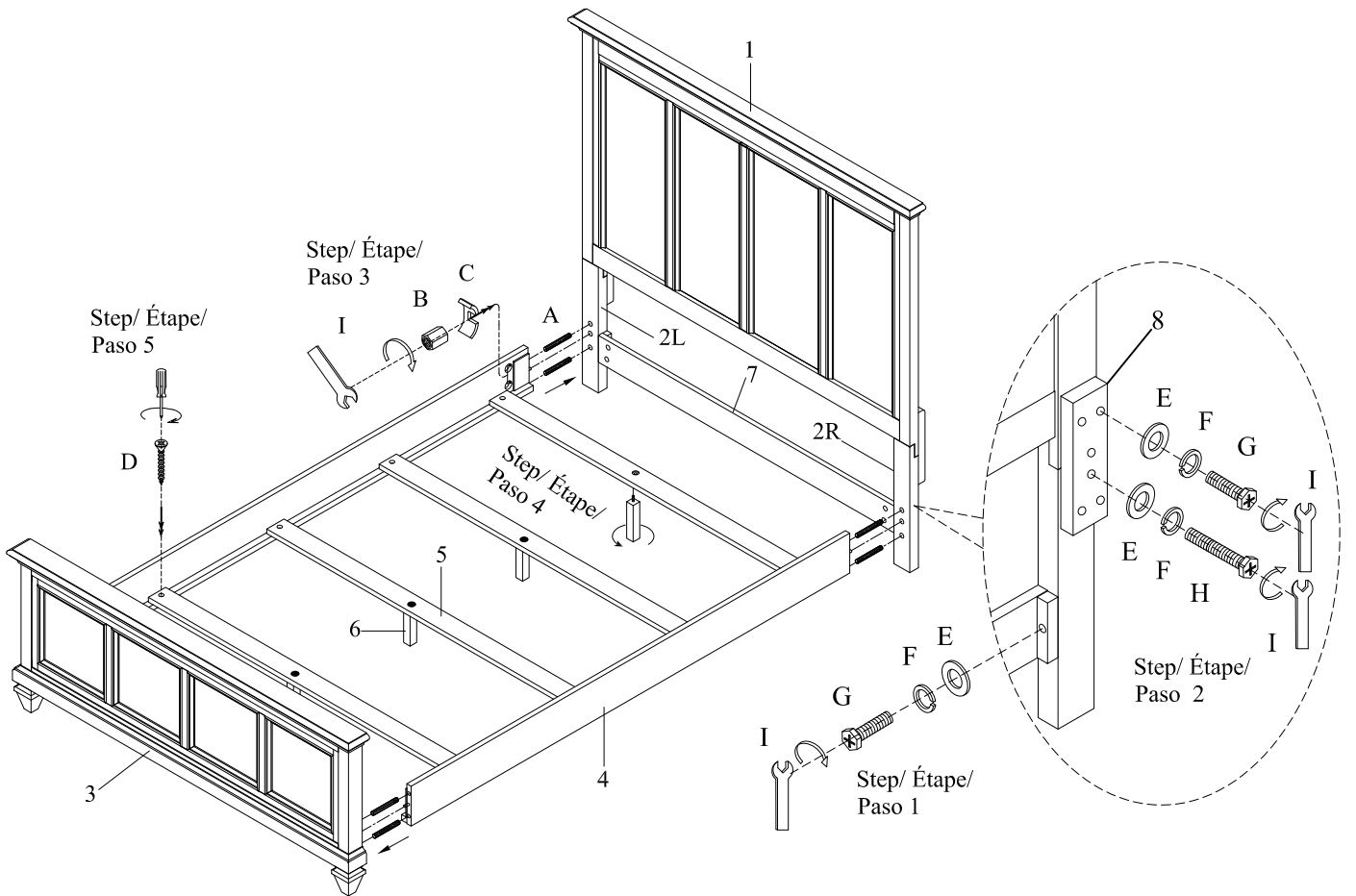
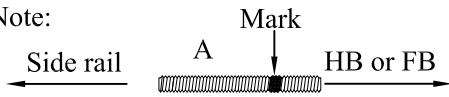

ASSEMBLY INSTRUCTIONS INSTRUCTIONS DE MONTAGE INSTRUCCIONES DE MONTAJE

KING PANEL BED HEADBOARD
KING PANEL BED FOOTBOARD
QUEEN/KING PANEL BED RAILS









CAUTION: PLEASE READ ALL INSTRUCTIONS BEFORE STARTING THE ASSEMBLY OF THIS PRODUCT. THESE PIECES ARE HEAVY. IN ORDER TO PREVENT PERSONAL INJURY AND ENSURE THAT THIS PRODUCT IS NOT DAMAGED DURING THE ASSEMBLY PROCESS, IT IS STRONGLY RECOMMENDED TO ENLIST THE ASSISTANCE OF ONE OR MORE PERSONS. IN CASE OF EXCESS STAIN, WIPE THE BOTTOM OF THE UNIT BEFORE PLACING ON ANY SURFACE.

ATTENTION: VEUILLEZ LIRE TOUTES LES INSTRUCTIONS AVANT DE COMMENCER L'ASSEMBLAGE DE CE PRODUIT. LES PIECES SONT LOURDES. POUR EVITER TOUTE BLESSURE ET POUR VOUS ASSURER QUE LE PRODUIT N'EST PAS ENDOMMAGE' PENDANT L'ASSEMBLAGE, NOUS VOUS RECOMMANDONS DE FAIRE APPEL A UNE OU PLUSIEURS AUTRES PERSONNES. EN CAS DE TACHE EXCESSIVE, ESSUYEZ LE FOND DE L'UNITE' AVANT LE PLACEMENT SUR N'IMPORTE QUELLE SURFACE.







CUIDADO: FAVOR DE LEER TODAS LAS INSTRUCCIONES ANTES DE ENSAMBLAR SU PRODUCTO, ESTAS. PIEZAS SON PESADAS. PARA PREVENIR HERIDAS PERSONALES Y ASEGURAR QUE SU PRODUCTO NO SEA DAN ADO MIENTRAS ES ENSAMBLADO. SE RECOMIENDA LA ASISTENCIA DE UNA O MAUS PERSONAS.

WARNING: PROTECTIVE GLIDE IS PLACED UNDER EACH LEG OF THE FURNITURE TO RESIST SCRATCHES ON FLOOR SURFACE. SOME FLOOR SURFACES CAN BE EXTRA SENSITIVE TO SCRATCHES AND MARKINGS, IF YOU ARE NOT SURE CONSULT WITH YOUR DEALER. AVERTISSEMENT. LES PIEDS DES MEUBLES SONT MUNIS DE PATINS DESTINES A PROTEGER LE PLANCHER. CERTAINS REVETEMENTS DE SOL PEUVENT ETRE TRES FRAGILES. EN CAS DE DOUTE. CONSULTER LE MARCHAND.

LIST OF PARTS AND HARDWARE/ LISTE DES PIÈCES ET DU MATÉRIEL/ LISTA DE PIEZAS Y HARDWARE

NO#/ NOMBRE/ NÚMERO	DESCRIPTION/ DESCRIPTION/ DESCRIPCIÓN		QUANTITY/ QUANTITÉ/ CANTIDAD
A	Bolt/ Boulon/ Tornillo	Ø5/16"x4 1/2"L	 8PCS
B	Nut/ Écrou /Nuez	Ø5/16"	 8PCS
C	Lock washer "C" / Rondelle de blocage "C" / Arandela de bloqueo "C"	Ø5/16"	 8PCS
D	Screw / Vis / tornillo de punta	M4-8x1"	 8PCS
E	Flat washer/ Rondelle plate/ Arandela plana	Ø5/16"x19mm	 14PCS
F	Lock washer/ Rondelle de blocage/ Arandela de bloqueo	Ø5/16"x11mm	 14PCS
G	Bolt/ Boulon/ Tornillo	Ø5/16"x2"L	 10PCS
H	Bolt/ Boulon/ Tornillo	Ø5/16"x3 1/4"L	 4PCS
I	Wrench / Clé/ Llave inglesa	12mm	 1PC

LIST OF PARTS AND HARDWARE/ LISTE DES PIÈCES ET DU MATÉRIEL/ LISTA DE PIEZAS Y HARDWARE

NO#/ NOMBRE/ NÚMERO	DESCRIPTION/ DESCRIPTION/ DESCRIPCIÓN		QUANTITY/ QUANTITÉ/ CANTIDAD
1	KING PANEL BED HEADBOARD		1PC
2L	Left Leg / Patte gauche / Pierna izquierda		1PC
2R	Right Leg / Patte droite / Pierna derecha		1PC
3	KING PANEL BED FOOTBOARD		1PC
4	QUEEN/KING PANEL BED RAILS		2PCS
5	Slat / Latte / Listón	 1952x76x18mm	4PCS
6	Slat Support / Support de lattes / soporte de lamas	 221x34x34mm	12PCS



NOTE:
ASSEMBLE UNIT ON A SOFT SURFACE.
ASSEMBLEZ L'UNITÉ SUR UNE SURFACE MOLLE.
ENSAMBLE LA UNIDAD EN UNA SUPERFICIE PLANA Y SUAVE.

DO NOT TIGHTEN BOLTS UNTIL THE UNIT IS COHMPLETELY ASSEMBLED.
NE SERREZ PAS LES BOULONS JUSQU'À CE QUE L'UNITÉ SOIT COHMPLÈTEMENT ASSEMBLÉE.
NO APRIETE LOS TORNILLOS HASTA QUE LA UNIDAD ESTE COHMPLETAMENTE ENSAMBLADA.

ASSEMBLY INSTRUCTIONS INSTRUCTIONS DE MONTAGE INSTRUCCIONES DE MONTAJE

KING PANEL BED HEADBOARD
KING PANEL BED FOOTBOARD
QUEEN/KING PANEL BED RAILS

LIST OF PARTS AND HARDWARE/ LISTE DES PIÈCES ET DU MATÉRIEL/ LISTA DE PIEZAS Y HARDWARE

NO#/ NOMBRE/ NÚMERO	DESCRIPTION/ DESCRIPTION/ DESCRIPCIÓN		QUANTITY/ QUANTITÉ/ CANTIDAD
7	Bottom Rail / Rail inférieur / Riel inferior		1PC
8	Mending plate / Plaque de réparation / Placa de reparación		2PCS

Note:

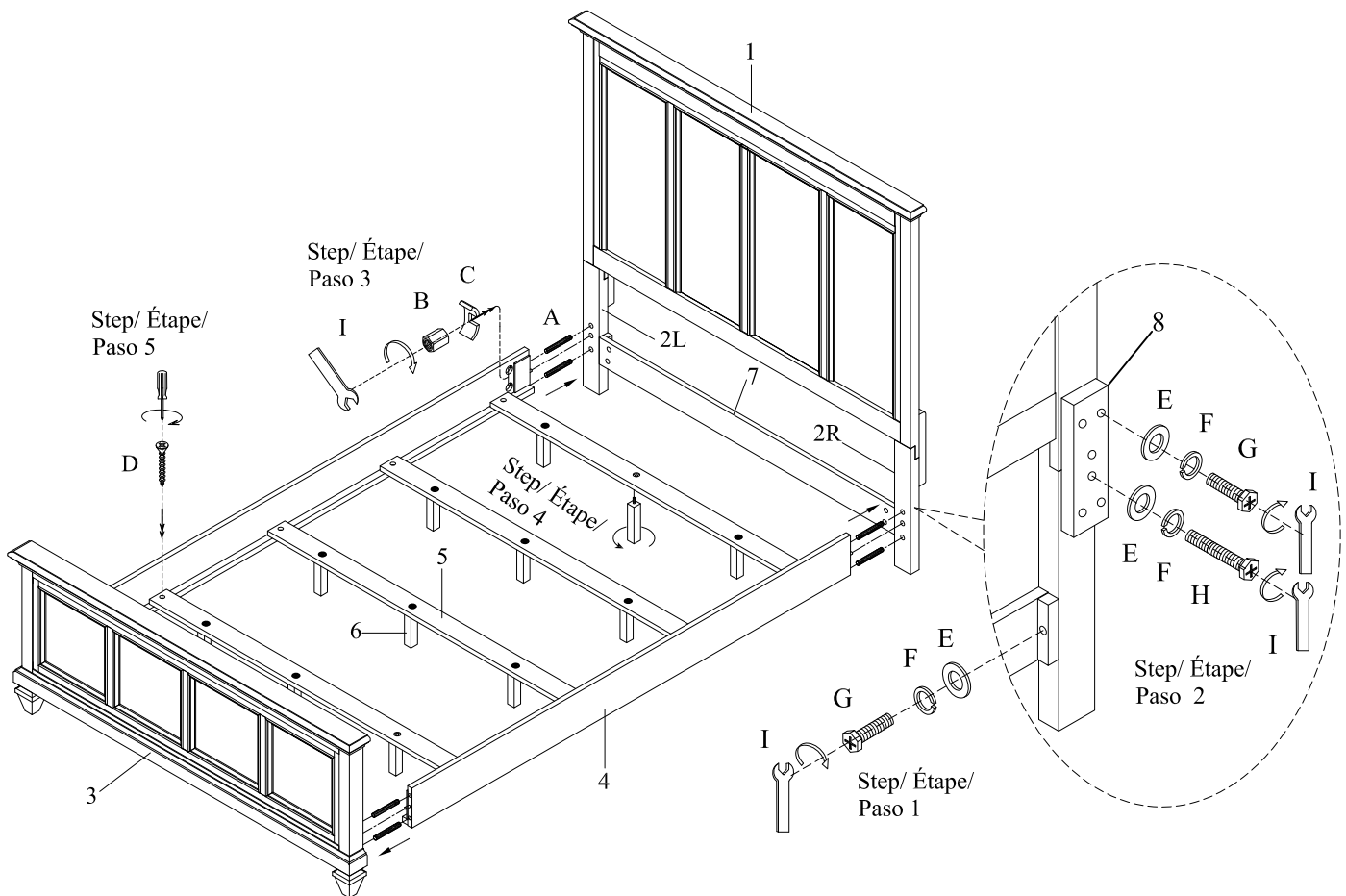
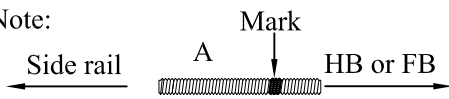

ASSEMBLY INSTRUCTIONS INSTRUCTIONS DE MONTAGE INSTRUCCIONES DE MONTAJE

KING PANEL BED HEADBOARD
KING PANEL BED FOOTBOARD
CAL. KING PANEL BED









CAUTION: PLEASE READ ALL INSTRUCTIONS BEFORE STARTING THE ASSEMBLY OF THIS PRODUCT. THESE PIECES ARE HEAVY. IN ORDER TO PREVENT PERSONAL INJURY AND ENSURE THAT THIS PRODUCT IS NOT DAMAGED DURING THE ASSEMBLY PROCESS, IT IS STRONGLY RECOMMENDED TO ENLIST THE ASSISTANCE OF ONE OR MORE PERSONS. IN CASE OF EXCESS STAIN, WIPE THE BOTTOM OF THE UNIT BEFORE PLACING ON ANY SURFACE.

ATTENTION: VEUILLEZ LIRE TOUTES LES INSTRUCTIONS AVANT DE COMMENCER L'ASSEMBLAGE DE CE PRODUIT. LES PIECES SONT LOURDES. POUR EVITER TOUTE BLESSURE ET POUR VOUS ASSURER QUE LE PRODUIT N'EST PAS ENDOMMAGE' PENDANT L'ASSEMBLAGE, NOUS VOUS RECOMMANDONS DE FAIRE APPEL A UNE OU PLUSIEURS AUTRES PERSONNES. EN CAS DE TACHE EXCESSIVE, ESSUYEZ LE FOND DE L'UNITE' AVANT LE PLACEMENT SUR N'IMPORTE QUELLE SURFACE.







CUIDADO: FAVOR DE LEER TODAS LAS INSTRUCCIONES ANTES DE ENSAMBLAR SU PRODUCTO, ESTAS. PIEZAS SON PESADAS. PARA PREVENIR HERIDAS PERSONALES Y ASEGURAR QUE SU PRODUCTO NO SEA DAN ADO MIENTRAS ES ENSAMBLADO. SE RECOMIENDA LA ASISTENCIA DE UNA O MAUS PERSONAS.

WARNING: PROTECTIVE GLIDE IS PLACED UNDER EACH LEG OF THE FURNITURE TO RESIST SCRATCHES ON FLOOR SURFACE. SOME FLOOR SURFACES CAN BE EXTRA SENSITIVE TO SCRATCHES AND MARKINGS, IF YOU ARE NOT SURE CONSULT WITH YOUR DEALER. AVERTISSEMENT. LES PIEDS DES MEUBLES SONT MUNIS DE PATINS DESTINES A PROTEGER LE PLANCHER. CERTAINS REVETEMENTS DE SOL PEUVENT ETRE TRES FRAGILES. EN CAS DE DOUTE. CONSULTER LE MARCHAND.

LIST OF PARTS AND HARDWARE/ LISTE DES PIÈCES ET DU MATÉRIEL/ LISTA DE PIEZAS Y HARDWARE

NO#/ NOMBRE/ NÚMERO	DESCRIPTION/ DESCRIPTION/ DESCRIPCIÓN		QUANTITY/ QUANTITÉ/ CANTIDAD
A	Bolt/ Boulon/ Tornillo	Ø5/16"x4 1/2"L	 8PCS
B	Nut/ Écrou /Nuez	Ø5/16"	 8PCS
C	Lock washer "C" / Rondelle de blocage "C" / Arandela de bloqueo "C"	Ø5/16"	 8PCS
D	Screw / Vis / tornillo de punta	M4-8x1"	 8PCS
E	Flat washer/ Rondelle plate/ Arandela plana	Ø5/16"x19mm	 14PCS
F	Lock washer/ Rondelle de blocage/ Arandela de bloqueo	Ø5/16"x11mm	 14PCS
G	Bolt/ Boulon/ Tornillo	Ø5/16"x2"L	 10PCS
H	Bolt/ Boulon/ Tornillo	Ø5/16"x3 1/4"L	 4PCS
I	Wrench / Clé/ Llave inglesa	12mm	 1PC

LIST OF PARTS AND HARDWARE/ LISTE DES PIÈCES ET DU MATÉRIEL/ LISTA DE PIEZAS Y HARDWARE

NO#/ NOMBRE/ NÚMERO	DESCRIPTION/ DESCRIPTION/ DESCRIPCIÓN		QUANTITY/ QUANTITÉ/ CANTIDAD
1	KING PANEL BED HEADBOARD		1PC
2L	Left Leg / Patte gauche / Pierna izquierda		1PC
2R	Right Leg / Patte droite / Pierna derecha		1PC
3	KING PANEL BED FOOTBOARD		1PC
4	CAL. KING PANEL BED		2PCS
5	Slat / Latte / Listón	 1952x76x18mm	4PCS
6	Slat Support / Support de lattes / soporte de lamas	 221x34x34mm	12PCS



NOTE:
ASSEMBLE UNIT ON A SOFT SURFACE.
ASSEMBLEZ L'UNITÉ SUR UNE SURFACE MOLLE.
ENSAMBLE LA UNIDAD EN UNA SUPERFICIE PLANA Y SUAVE.

DO NOT TIGHTEN BOLTS UNTIL THE UNIT IS COHMPLETELY ASSEMBLED.
NE SERREZ PAS LES BOULONS JUSQU'À CE QUE L'UNITÉ SOIT COHMPLÈTEMENT ASSEMBLÉE.
NO APRIETE LOS TORNILLOS HASTA QUE LA UNIDAD ESTE COHMPLETAMENTE ENSAMBLADA.

ASSEMBLY INSTRUCTIONS INSTRUCTIONS DE MONTAGE INSTRUCCIONES DE MONTAJE

KING PANEL BED HEADBOARD
KING PANEL BED FOOTBOARD
CAL. KING PANEL BED

LIST OF PARTS AND HARDWARE/ LISTE DES PIÈCES ET DU MATÉRIEL/ LISTA DE PIEZAS Y HARDWARE

NO#/ NOMBRE/ NÚMERO	DESCRIPTION/ DESCRIPTION/ DESCRIPCIÓN		QUANTITY/ QUANTITÉ/ CANTIDAD
7	Bottom Rail / Rail inférieur / Riel inferior		1PC
8	Mending plate / Plaque de réparation / Placa de reparación		2PCS

Note:

