

INSTRUCTION MANUAL

Creative Fan Light

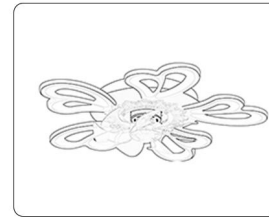

※Note: The installation of other designs have the same steps and need to read carefully before installation.

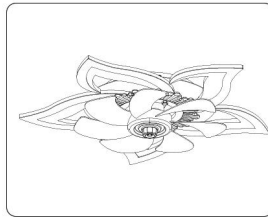
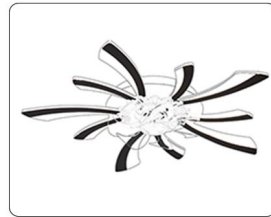









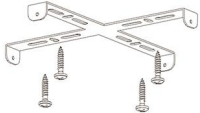
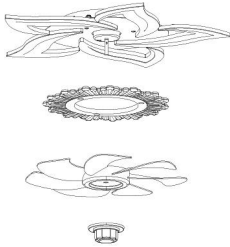

Thank you for choosing our fan lights!
Please be sure to read the manual carefully in order to ensure full understanding of installation and use of this product.

Integrate the functions
of lighting and fan

CONTENTS //

1.Packing list	01
2.Mounting bracket installation	02
3.Wiring instructions	04
4.Installation instructions	05
5.Remote control	07
6.Mobile App Control Operation	08
7.Care & Maintenance	09

1.Packing list

Item	Item	Illustration	Quantity
01	Mounting bracket*1 Self-tapping Screw*4		2
02	Light band*1 <small>(with cable pre-installed, just need to fix the screws)</small> Decorative part*1 <small>(to be installed between the light band and the fan)</small> Fan blade*1 Fan Cap*1		4
03	Instruction Manual*1		1
04	Remote control*1		1
05	Screw packs, terminal blocks	<div style="display: flex; flex-wrap: wrap;"> <div style="width: 50%;">  <p>Screw A * 4 (1 pcs spare)</p> </div> <div style="width: 50%;"> <p>For the main body of the ceiling fan</p> <ul style="list-style-type: none">  Spare Screw C * 6  Spare Screw Nut C * 2 </div> <div style="width: 50%;">  <p>Terminal blocks*1</p> </div> <div style="width: 50%;"> <p>Connecting the light band</p> <ul style="list-style-type: none">  Spare Screw Nut B * 2  Spare Screw Washer B * 2  Spare Screw B * 2 </div> <div style="width: 50%;">  <p>Cable tie * 3</p> </div> <div style="width: 50%;"> <ul style="list-style-type: none">  screw with plastic wall anchor*4 </div> </div>	6

Note:Please make sure everything listed above is included,
contact us for help if there is anything missing.



Before the installation of the fan light, pay attention to the safety precautions and prepare the tools needed.

1. Turn off the power supply before installation or disassembly of the fan light. If you have a multimeter or voltage tester, it is a good idea to test whether the power is off.
2. The wiring sequence for installation must be ground line, null line(N), live line(L), while for disassembly, it must be live line(L), null line(N) and then ground line to avoid electric shock.
3. Make sure to tighten each screw.
4. When the fan is working, avoid touching the fan blade.

Installation tools:



Electric drill



Wrench



Ladder



Pincer



Screwdriver



Tape

2. Install the mounting bracket

2.1 Take out four screws of accessory package and use them as shown in the illustration.

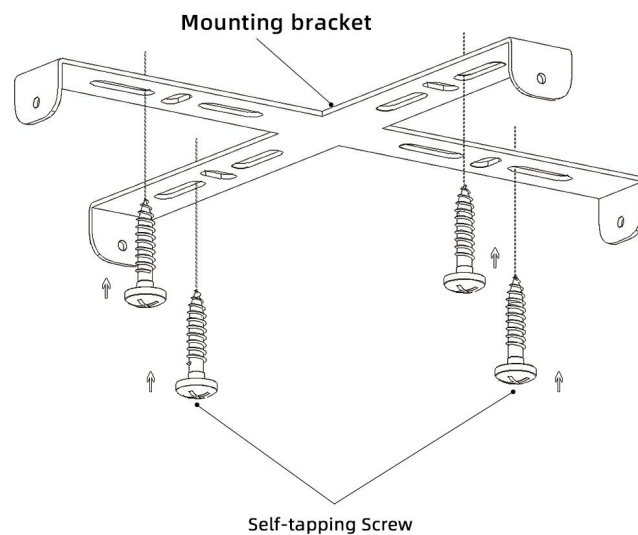

2.2 When installing on a wooden ceiling, the mounting bracket is fixed tightly with wooden tooth screws or crossbeams.

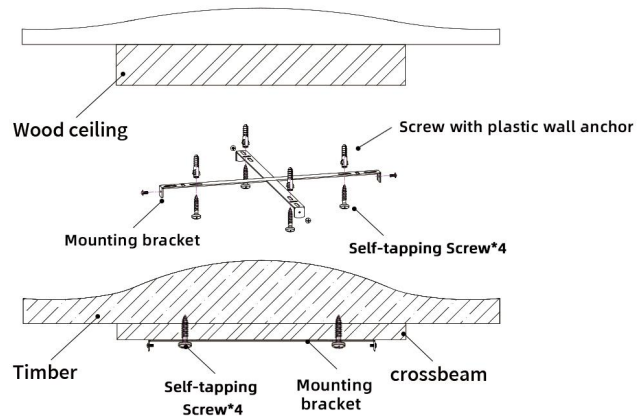

2.3 To install on the concrete ceiling, use 8mm impact drill bit to drill depth of 50mm firstly, then use the expansion screws in the accessory package to fix the mounting bracket on the ceiling.

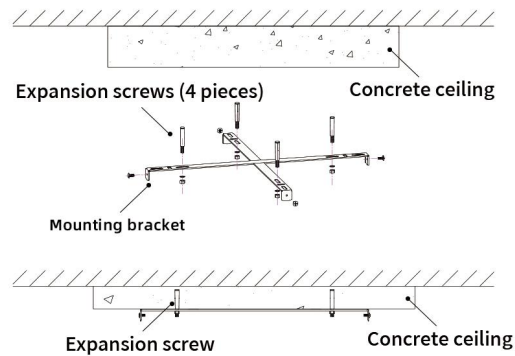

Attention: Please use 8mm diameter drill bit to drill hole first, and then use M6 expansion screws for installation.



Please note:

1. If you use a wooden ceiling as the installation surface, please ensure that thickness of wooden board at the installation location is not less than 30MM and weight force is not less than 30KG
2. To ensure reliable fixation, please use the corresponding fixing screws according to the above instructions when installing on ceilings of different materials.

3. Wiring instructions

3.1 Please follow instructions to connect all the power cords to connecting terminal.

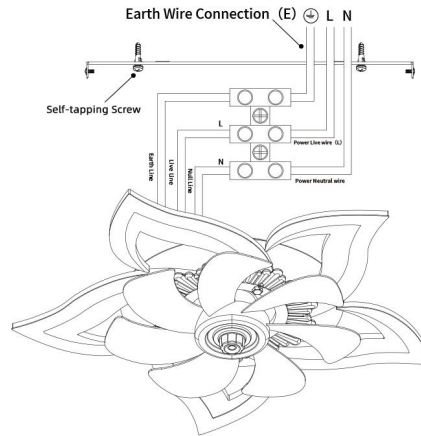

3.2 Please tighten the main part of the fan light and the holder using four screws.

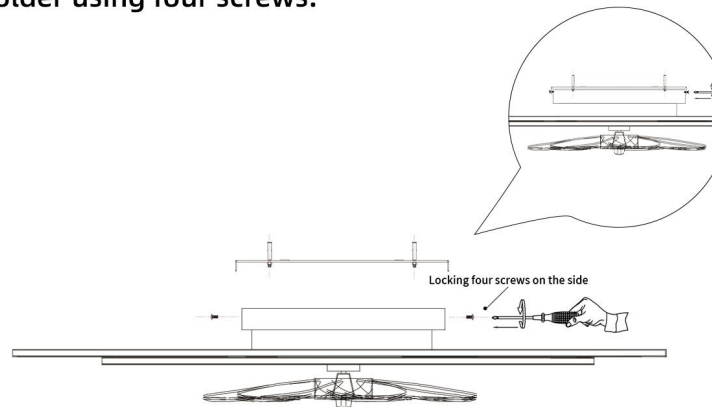

Attention:

1. Before installation, carefully check the appearance of the fan light. Contact us for help if there is any damage.
2. Make sure the power is off before installation.
3. Make sure the L lines and N lines are well wired or there would be abnormal light flash.

4. Installation step instructions

Step 1

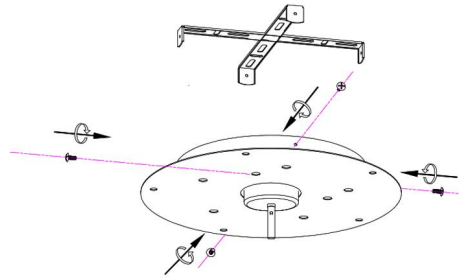

Unscrew side screws and remove the mounting bracket

Step 2

Fix the flower shape light band as shown by tightening screws and spacers, screws and cables are pre-installed, no extra screws are needed

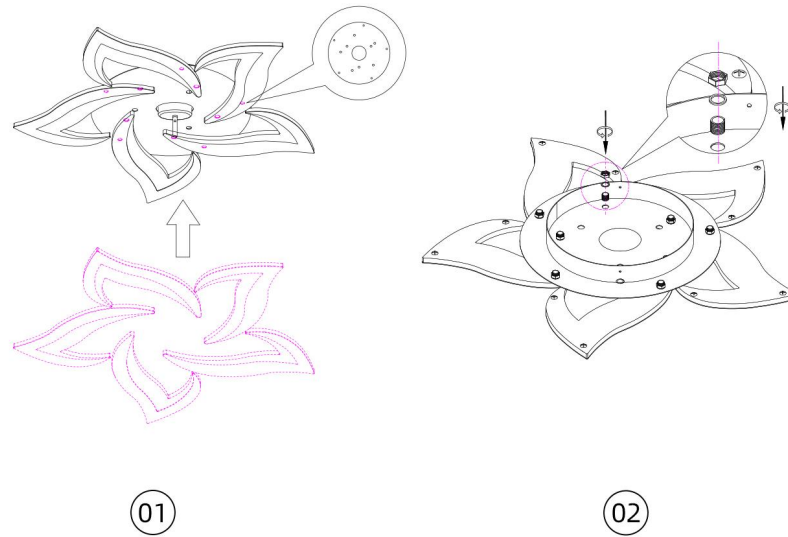

Step 3

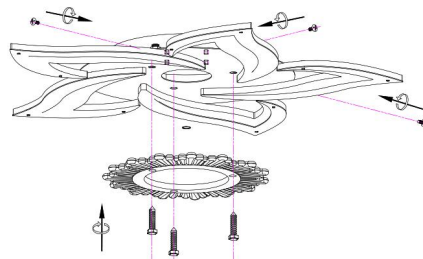

Connect acrylic decorative parts to the main body using 3 screws

Step 4

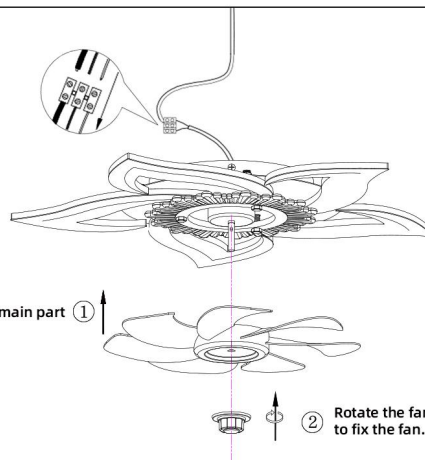

Attach the fan blade to the main part ①

② Rotate the fan cap counter-clockwise to fix the fan.

Step 5



Install expansion screws on the ceiling ①

Press the mounting bracket and fix it with screws ②

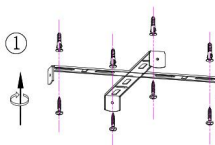

There is lock with groove on the main part, use ③ four screws to fix the fan light to the mounting bracket.

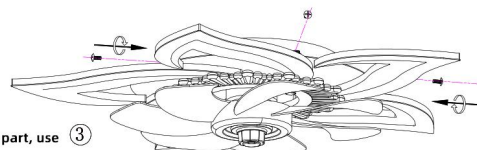

5.Remote control

1. Introduction to the key functions of the remote control



Description of code matching method

1. Turn on the wall power switch, long press the "SETUP" key for 5 seconds until hearing a "DI" sound. After hearing the sound twice, the match is done successfully.
2. If not matched, turn off the power for one minute and repeat the step mentioned above.
3. If the remote control is not working, change the battery and try again.

- Turn on the light/Turn off the light
- All off
- Change color temperature
- Night lamp
- Increase brightness
- Reduce brightness
- Increase color temperature
- Reduce color temperature
- Forward rotation/ Reverse rotation
- Timing function 2 hours
- Fan speed selection, 1 for minimum, 6 for maximum.
- Natural wind
- Turn off the fan



Scan to download
APP control

Software download: Scan QR code to download

1. Download Software: Scan the QR code to download and install the APP. Follow the instructions to register a user account.
2. Add Your Device: After logging the APP, click "+" in the upper right corner to add a device. Fill in the information needed(device name, room and device type) according to the instruction to complete the procedure.
3. Match Code: After adding the device, click the device icon to enter device detail page. Power off your device for 1-2 seconds and then power on again. Click the "matching" button on the bottom right corner, the light would flash for 3 times and the matching is done successfully. You can use the APP to control several devices at the same time.

6. Mobile App Control Operation



1.
Turn off the lights



2.
Scan the QR code
and download
the app, works with
IOS/Android system



3.
Choose your room
& click "+" to add d
evice (turn on mobile
blue-tooth)



4.
Turn on the light



5.
Turn on wall switch and
click "Wi-Fi" to pair within
5 seconds

7. Care and maintenance

7.1 About product maintenance

1. In order to use this product safely and efficiently, please clean the dust of the fan lamp once a year. For the removal method, please refer to the previous installation steps. If conditions permit, butter can also be applied to each rotating part of the motor to reduce the abnormal noise caused by the friction of the parts.

7.2 Questions and answers encountered during use

Q1: What should I do if the fan light does not start normally?

A: Check the power supply to see whether there is short circuit or the voltage is lower than required(AC220V±10%).And if no problem with power supply, check if the fan light is well connected.

Q2: The fan light does not respond when using the remote control for the first time?

A: Make sure the fan light is well connected and the power is on. And check the battery of the remote control. If everything alright, try to repeat the matching process. Just contact us if any help needed.

Q3: There is a sound but the remote control does not work normally?

A: Please check the wiring of the fan light, see if they are well connected. Make sure you turn off the power supply when checking.

Q4: The fan light is normal, but the fan is running but there is no wind, what's the matter?

A: Most probably is that you have pressed the reverse rotation button, just press again to get back to forward rotation.

Q5: When turning on the wall control switch the light flashed but did not light up, and there was no response when pressing the remote control?

A: Check if the fan light is well connected, if yes, then there might be something wrong with the controller, just contact us for replacement of the controller.

Q6: What should I do if the fan light makes noise?

A: 1. Check if the wires at the back of the fan light are close to the motor, adjust if yes.
2. Make sure that the fan light is not damaged before installation.
3. Check if the fan light is installed firmly.
4. Installation on a wooden suspended ceiling, steel structures or prefabricated panels are not recommended because they would amplify the sound.

Note: If further help is needed, please contact us.



Warning: In order to prevent fire and electric shock accidents, please use electrical switches and wires that meet national safety standards, please turn off the power supply during maintenance or cleaning to avoid personal injury accidents!