

Assembly Instruction

SECTIONAL SOFA

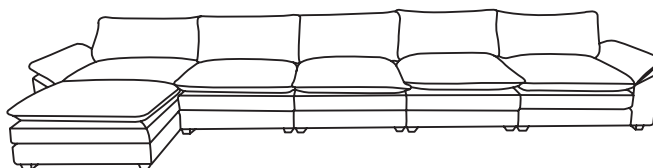

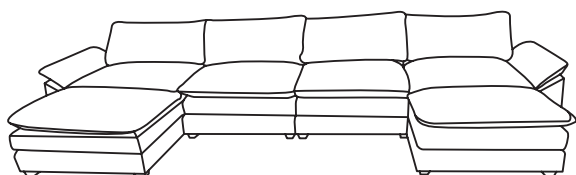

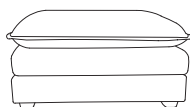
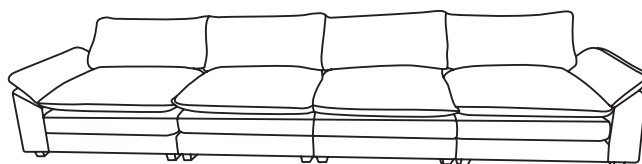
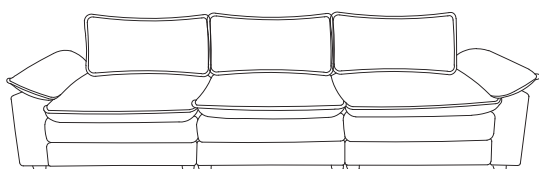
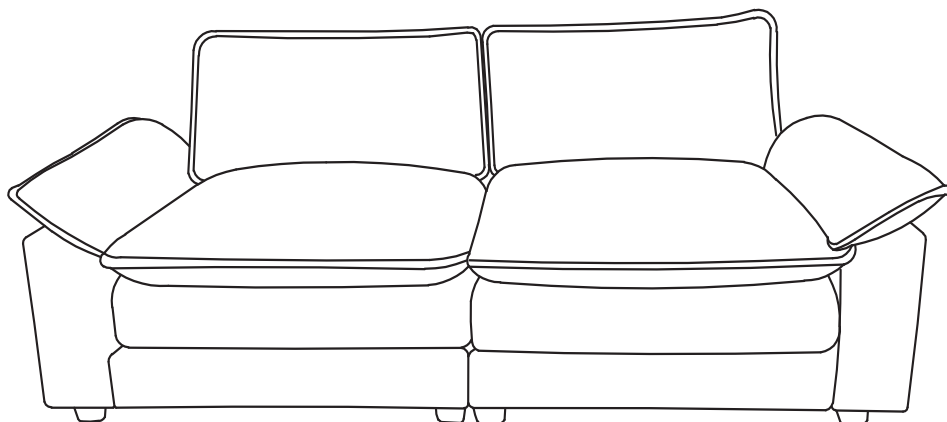





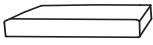

Thank you for choosing our product.

To ensure safe and satisfactory use of this product, please carefully read the below instructions beforehand.











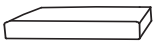

1. This sofa ships in several boxes, we recommend unpacking and starting assembly when all boxes are received.
2. Our cushions are vacuum packed for convenient shipping. Please allow 2-3 days for them to fully expand to their original shape and for any wrinkles to disappear.
3. In the event that a part is damaged or missing, no need to return the product, we will gladly help and ship your replacement parts free of charge.

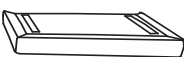
PART LIST & HARDWARE





1

<p>A Seat frame</p>  <p>2PCS</p>	<p>D Backrest</p>  <p>2PCS</p>	<p>G Seat cushion</p>  <p>2PCS</p>	<p>I Back Cushion</p>  <p>2PCS</p>	<p>N Washer</p>  <p>24PCS+1PC</p>
<p>O M8*60mm Bolt</p>  <p>White</p> <p>8PCS</p>	<p>P 5/16 *80mm Bolt</p>  <p>yellow</p> <p>4PCS</p>	<p>Q Butterfly Nut</p>  <p>4PCS</p>	<p>R Alley Key</p>  <p>1PC</p>	<p>L Gasket</p>  <p>8PCS</p>
<p>M Leg</p>  <p>8PCS</p>				

2

<p>A Seat frame</p>  <p>1PC</p>	<p>D Backrest</p>  <p>1PC</p>	<p>G Seat cushion</p>  <p>1PC</p>	<p>I Back Cushion</p>  <p>1PC</p>	<p>C Ottoman frame</p>  <p>1PC</p>
<p>H Ottoman cushion</p>  <p>1PC</p>	<p>M Leg</p>  <p>8PCS</p>	<p>O M8*60mm Bolt</p>  <p>White</p> <p>8PCS</p>	<p>P 5/16 *80mm Bolt</p>  <p>yellow</p> <p>4PCS</p>	<p>Q Butterfly Nut</p>  <p>4PCS</p>
<p>L Gasket</p>  <p>8PCS</p>	<p>N Washer</p>  <p>24PCS+1PC</p>	<p>R Alley Key</p>  <p>1PC</p>		

3

<p>J armrest cushion</p>  <p>2PCS</p>	<p>E Armrest</p>  <p>2PCS</p>	<p>O M8*60mm Bolt</p>  <p>White</p> <p>8PCS</p>	<p>N Washer</p>  <p>8PCS</p>	<p>R Alley Key</p>  <p>1PC</p>
---	---	---	--	--

Note: Please retain all boxes until you are certain that your product isn't damaged and that you do not wish to return it. Disposal of boxes may prevent our ability to resolve your request.

STEP 1: Connect armrest (E) & Seat frame (A) with Bolts (O) and Washers (N).

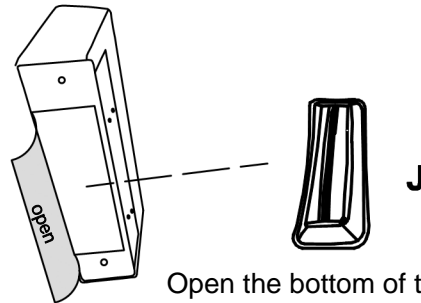
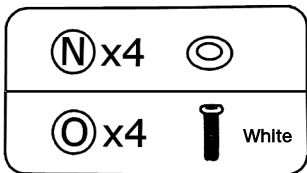
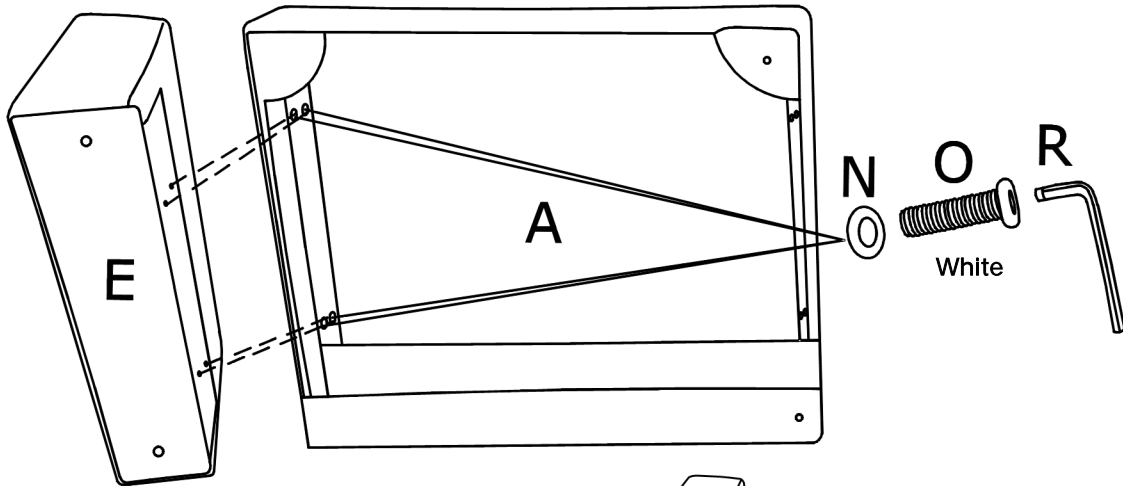

Open the bottom of the armrest and take out the armrest cushion

STEP 2: Connect armrest (E) & Seat frame (A) with Bolts (O) and Washers (N).

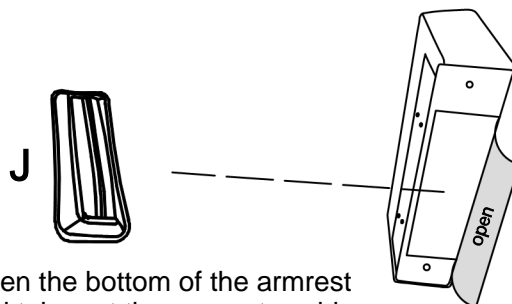
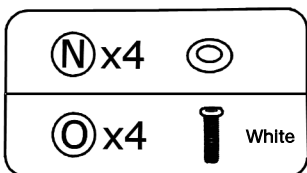
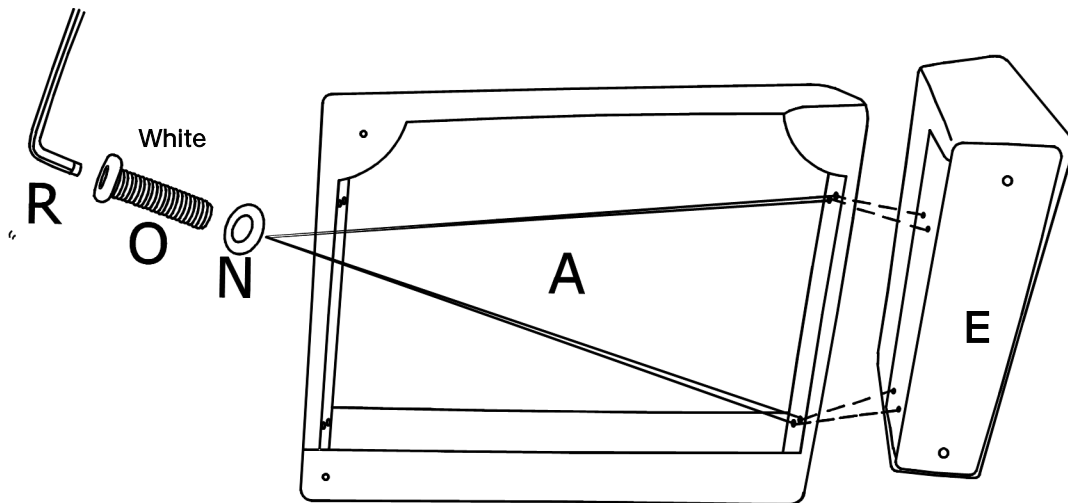

Open the bottom of the armrest and take out the armrest cushion

STEP 3: Install sofa legs, screw in Legs (M) and Gaskets (L).

If you buy a multi-seater sofa, the assembly process is the same as for loveseat sofa

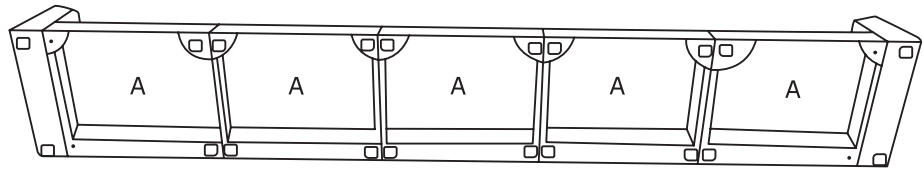
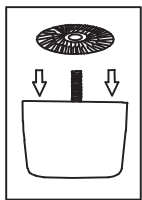
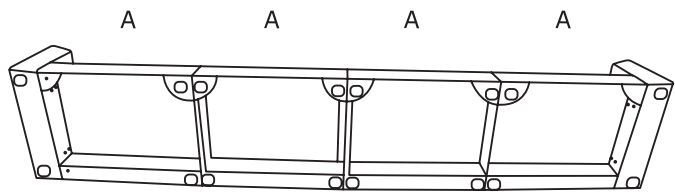
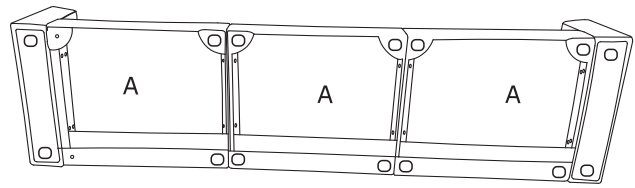
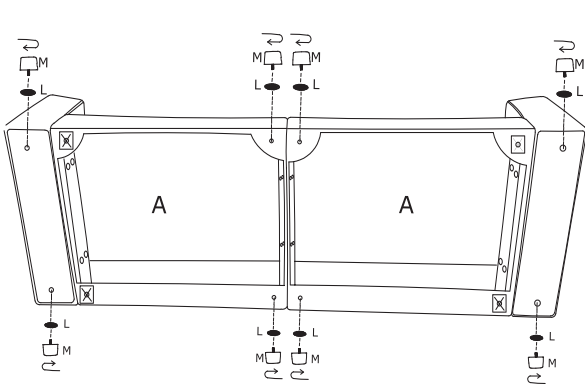

STEP 4: Connect Seat frame (A) and parts from step 1&step 2 with Bolts(P), Washers(N) and Butterfly nuts(Q).

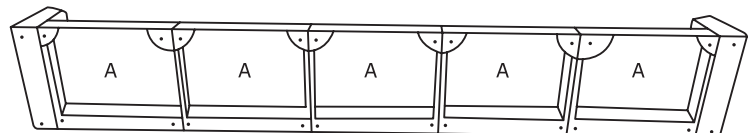
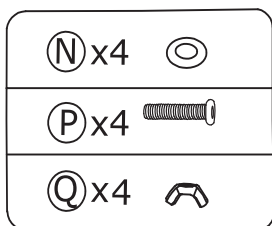
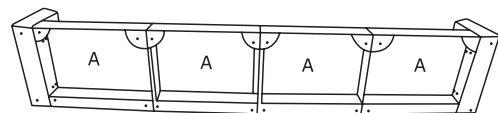
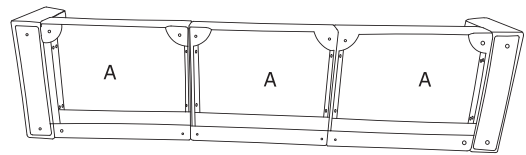
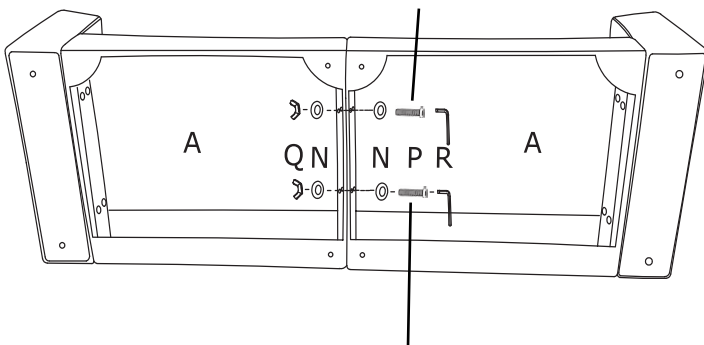

STEP 5: Install ottoman legs, screw in Legs (M) and Gaskets (L).

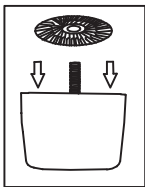
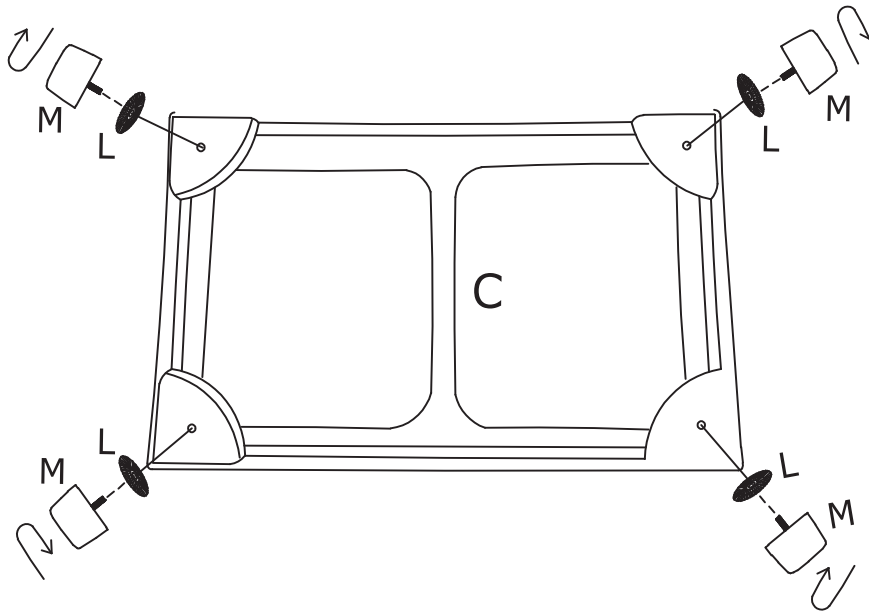

STEP 6: Line up the holes in the Backrest(D) with corresponding holes on the frame. Insert Bolts(O) and Washers(N), tighten securely after the have all been placed.

If you buy a multi-seater sofa, the assembly process is the same as for loveseat sofa

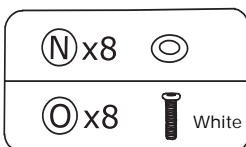
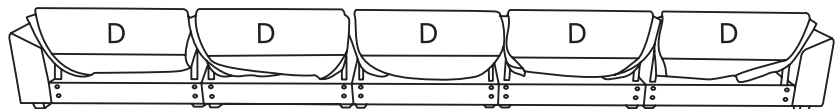
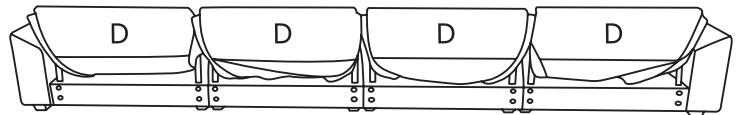
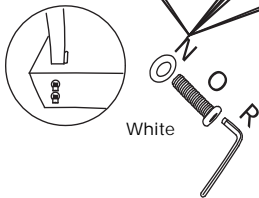
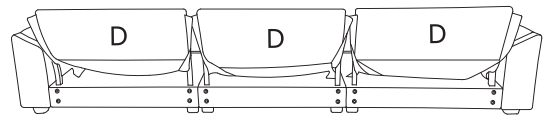
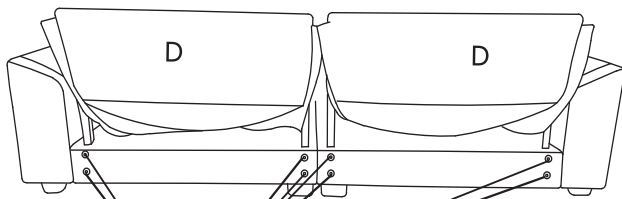

STEP 7: Use scissors to open all the vacuum sealed cushions and arm pillows. It may take 48-72hrs to fully expand back to its original shape.

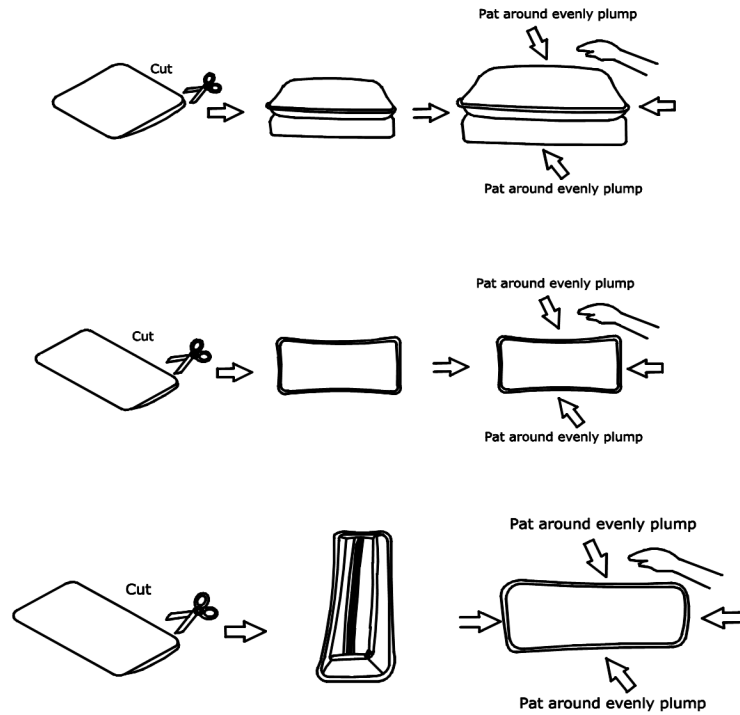

STEP 8: Attach arm cushion(J) into designated position.

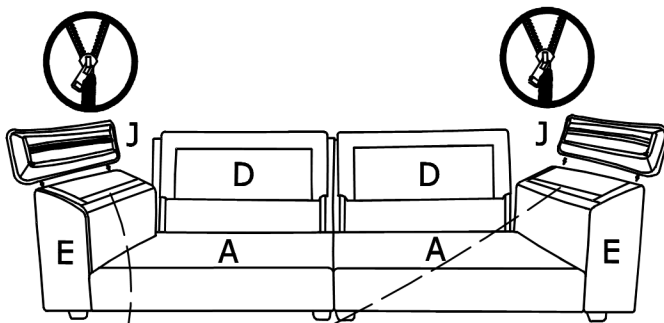

If you buy a multi-seater sofa, the assembly process is the same as for loveseat sofa

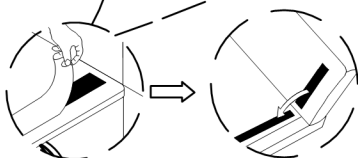
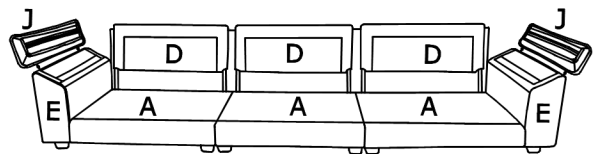

Note: Need remove the magic cloth from the velcro before assembly the seat

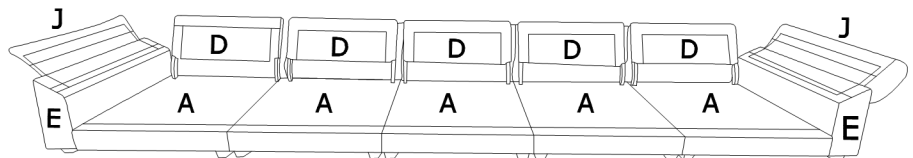
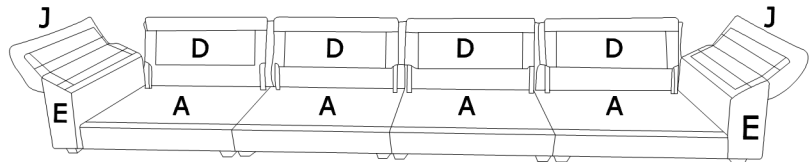

STEP 9: Add the cushions and you're done.

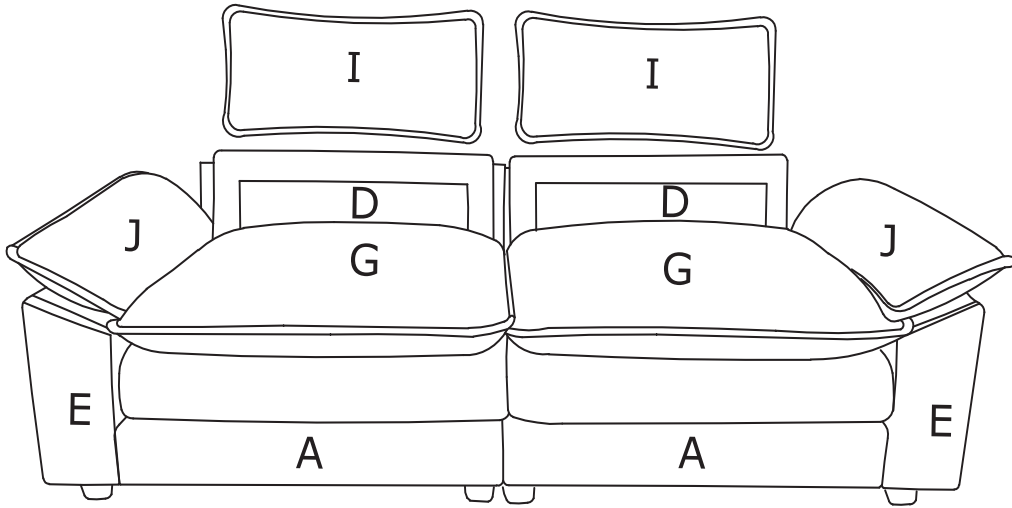

1&3

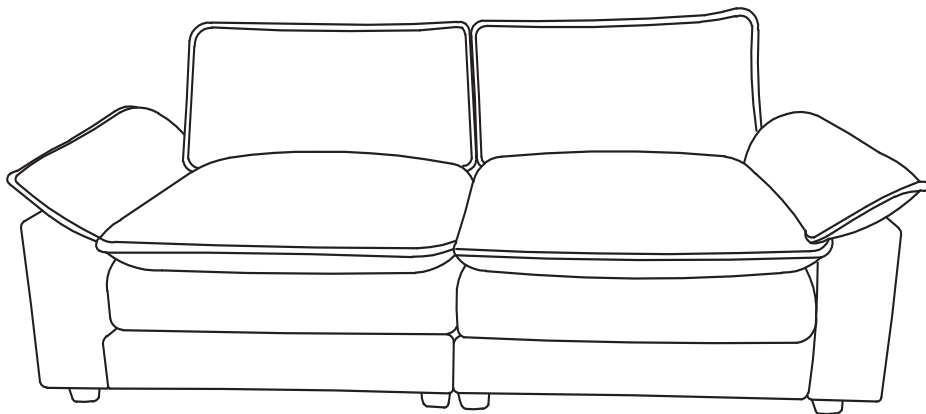

1&2&3

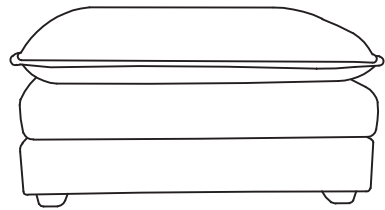
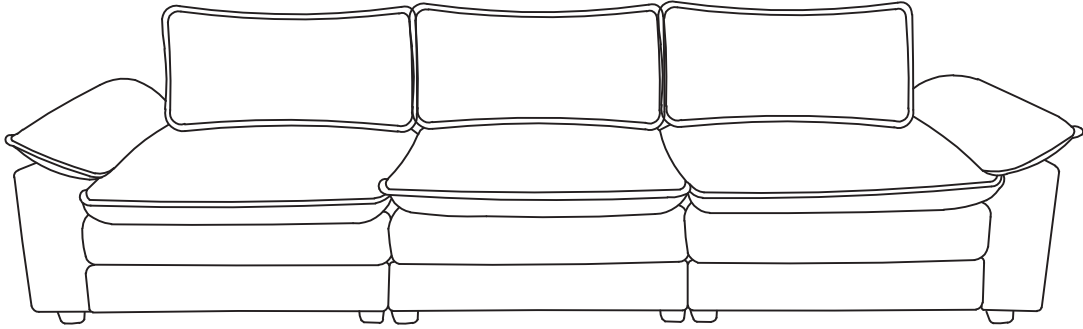

1&1&3

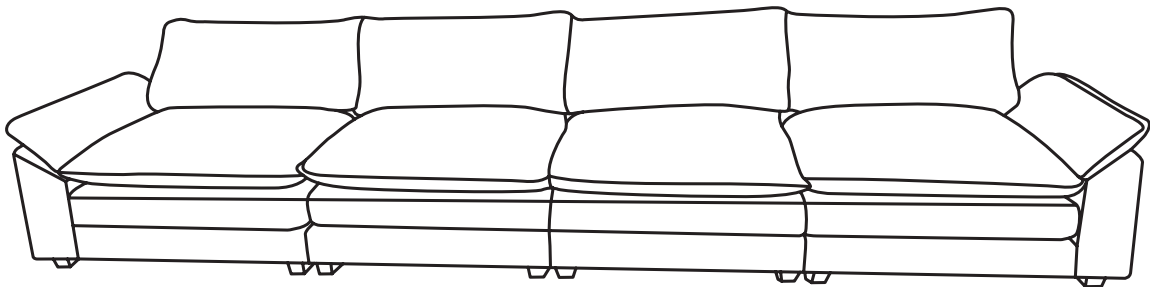

1&2&2&3

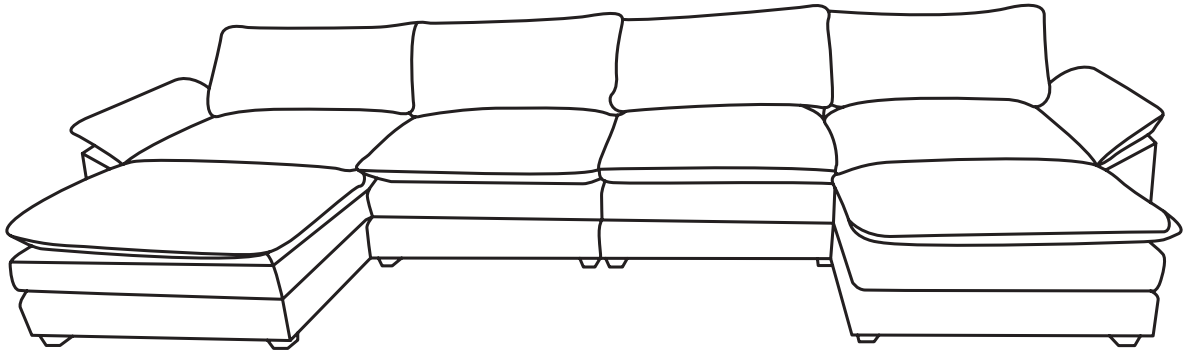

1&1&2&3

