

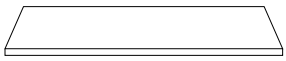

	30'
		
		2

<p>A</p>  <p>x 1</p>	<p>B</p>  <p>x 1</p>	<p>C</p>  <p>x 1</p>	<p>D</p>  <p>x 1</p>
---	---	---	---

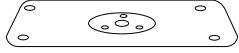

<p>E</p>  <p>M8 x 25</p> <p>x 6</p>	<p>F</p>  <p>x 6</p>	<p>G</p>  <p>x 1</p>	<p>H</p>  <p>M6 x 14</p> <p>x 4</p>	<p>I</p>  <p>x 4</p>
--	---	---	---	---

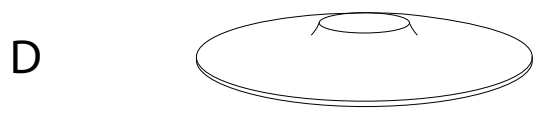
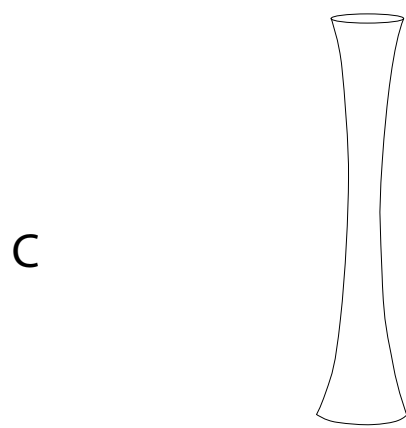
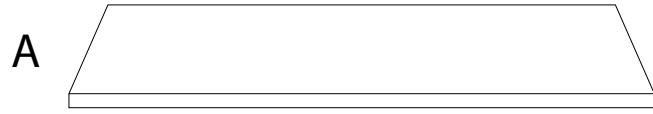
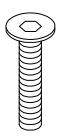
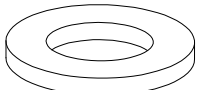
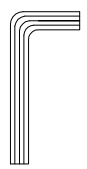
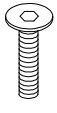
1

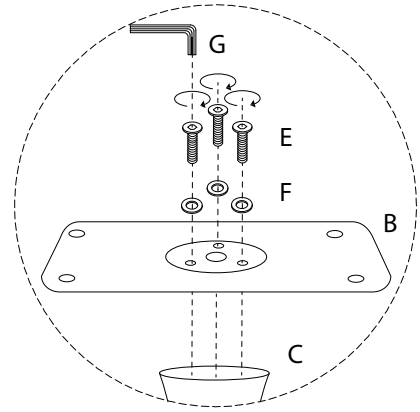
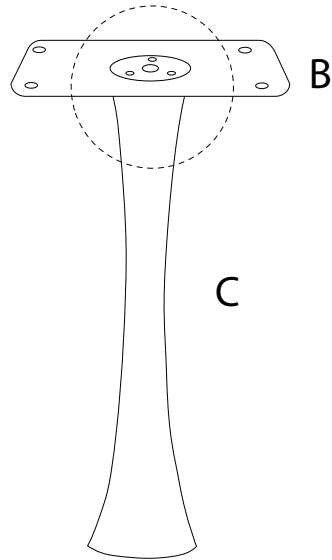
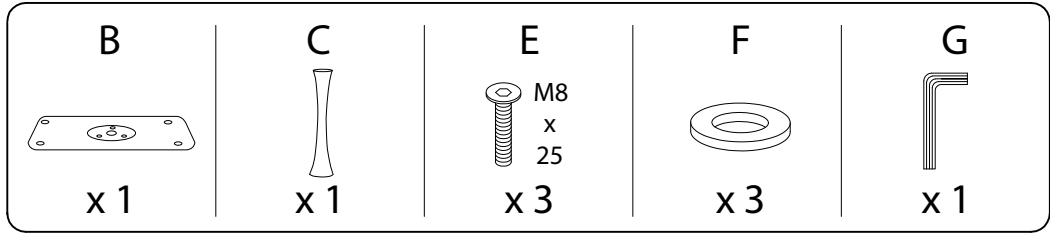

2

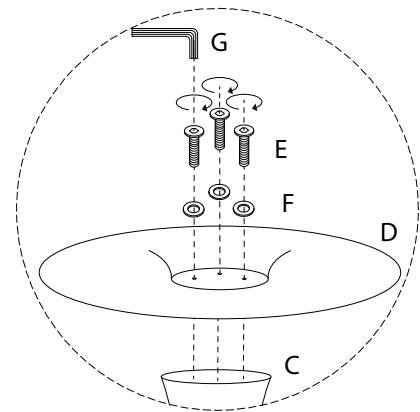
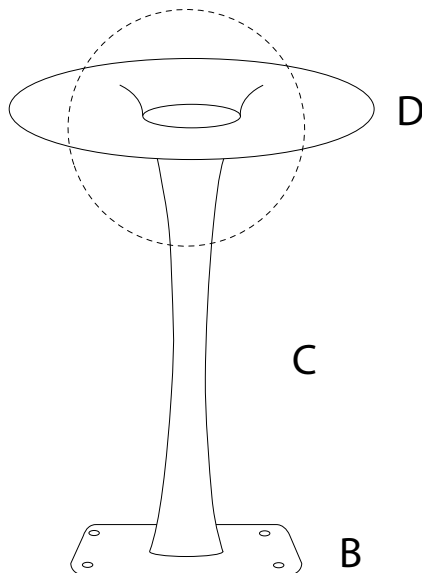
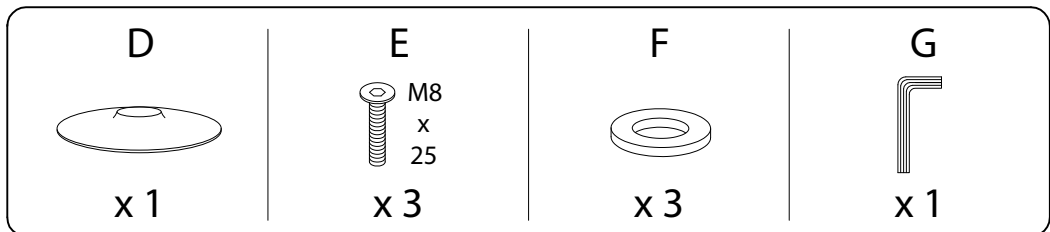

3

