

# SAUNA USER MANUAL

The new generation of sauna room



**FOR INDOOR USE ONLY**

**240V AC 15A DEDICATED CIRCUIT**

**Dear users,**

**Please read this direction carefully before use and keep it cautiously for the future. The installation of the sauna requires a minimum of 3 people. You should not try to install the sauna on your own as damage will easily occur.**

## **LIST OF CONTENTS**

- A. TECHNICAL PARAMETERS
- B. OPERATING CONDITIONS
- C. CHARACTERISTICS
- D. INSTALLATION PROCEDURE
- E. OPERATION INSTRUCTIONS
- F. RECOMMENDATIONS FOR USE
- G. CAUTIONS
- H. CLEANING & MAINTENANCE
- I. TROUBLESHOOTING
- J. WARRANTY

## A. TECHNICAL PARAMETERS

- Power: AC240V 15AMP
- Watt: 2730W
- Temperature range: 77-150°F
- Time range: 5-90 min
- Lighting apms: 1A
- Oxygen bar: DC12v with direction
- Blue tooth version: V2.1 + EDR
- Blue tooth effective distance: 10 meters

## B. OPERATING CONDITIONS

- Temperature: Minus 5°C-40°C(23°F-104°F)
- Comparative humidity:  $\leq 85\%$ ;
- Atmospheric pressure: 86kpa~106kpa;
- Power: AC 240V,60HZ.

## C. CHARACTERISTICS

- Wooden frame;
- Electronic controls and constant temperature automatically;
- Imported high-precise numerical transporter;
- Electronic keying;
- Heating Plate + Heating Tube

**PLEASE READ ENTIRE MANUAL THROUGH BEFORE PROCEEDING WITH INSTALLATION.**

## **D. INSTALLATION PROCEDURE**

### **CAUTION:**

- When installing and using this electrical equipment, basic safety precautions should always be followed.
- At least three people are required for installation.
- No plumbing or plumbing fixtures should be placed in the sauna.
- Keep all liquids away from the heating panels.
- Install sauna on a completely level surface.
- Install sauna in an area that is dry.
- Flammable objects and Corrosive chemical substances should be kept far away from the sauna.

# I PARTS Packing A

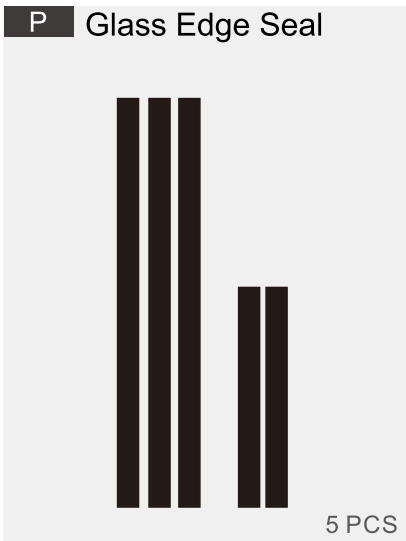
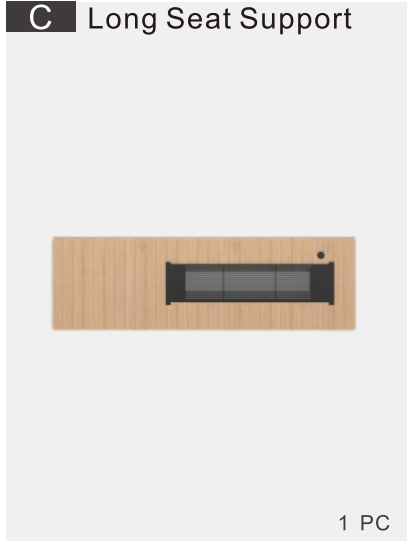
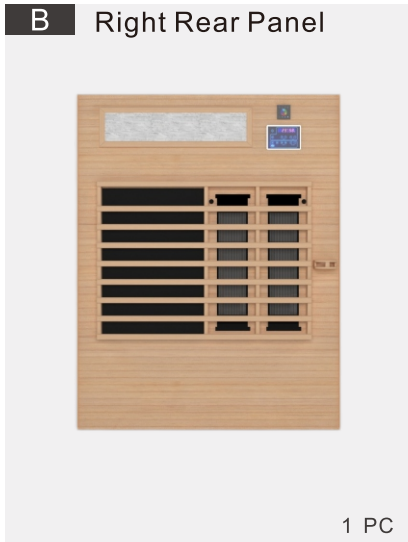
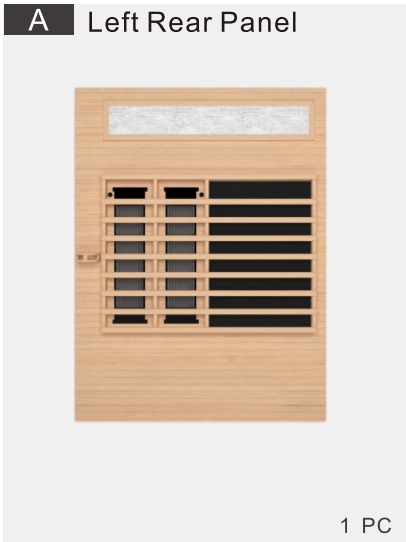

# PARTS Packing B

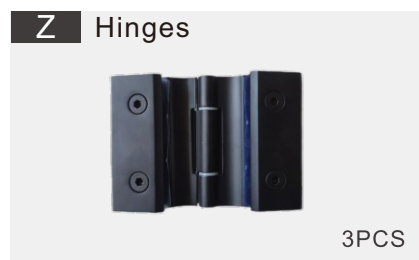
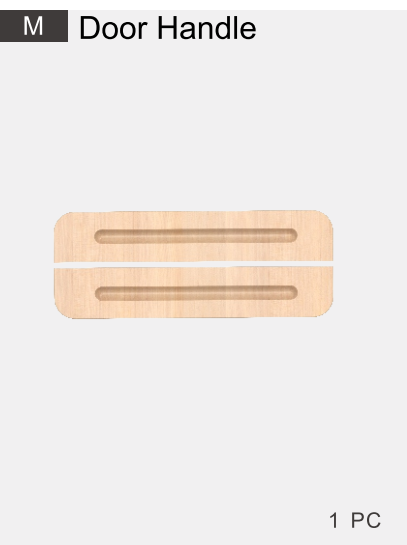
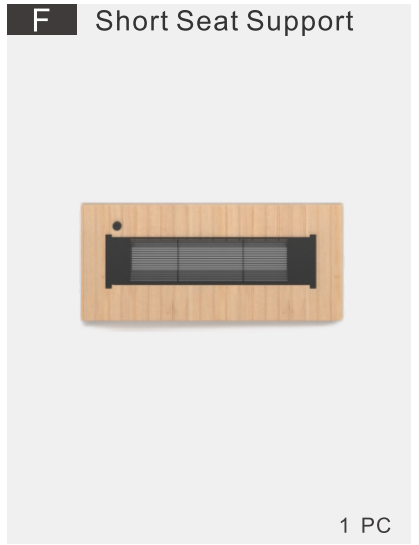
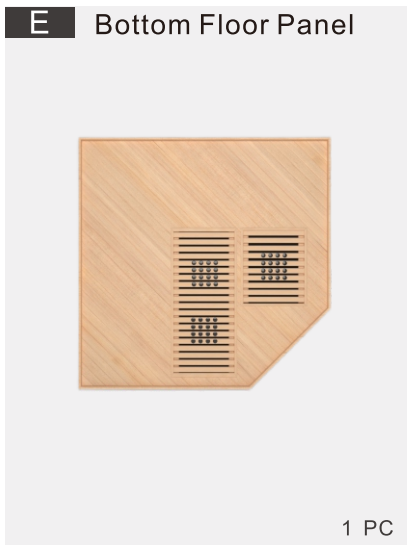

# I HARDWARE

**ST3.5\*50mm**

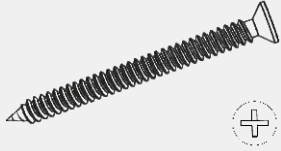

Seat Panel\*6  
 Seat Pillar\*8  
 Glass top and bottom seals\*12  
 Seat side support\*4  
 Spare\*4  
**34 PCS**

**ST3.5\*25mm**

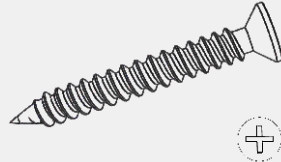

Glass Edge Seal\*10  
 Cup Holder\*4  
 Spare\*4  
**18 PCS**

**ST3\*20mm+Spacer**

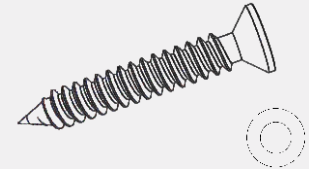

Fixed glass\*12  
 Spare\*4  
**16 PCS**

**φ6\*70mm**



Door Handle\*2  
 Spare\*2  
**4 PCS**

**ST3.5\*15mm**

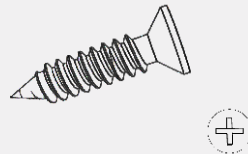

Oxygen Bar\*2  
 Roof panel \*8  
 Spare\*4  
**14 PCS**

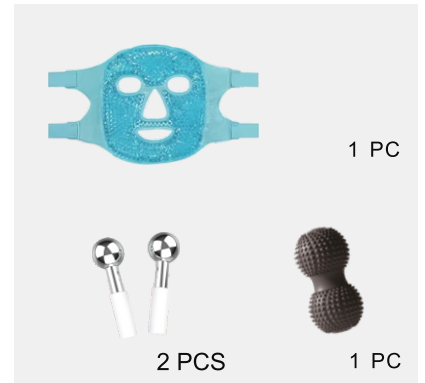

**1 PC**

**2 PCS**

**1 PC**

## PARTS Packing C

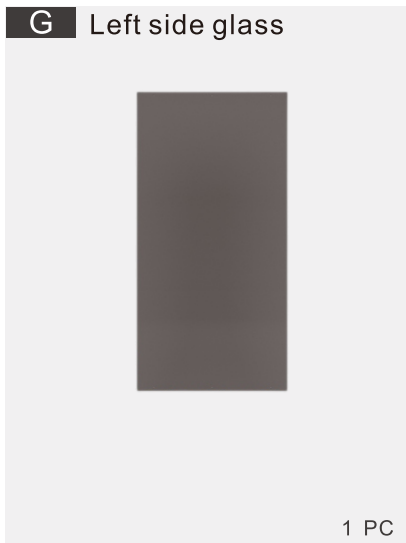

## PARTS Packing D

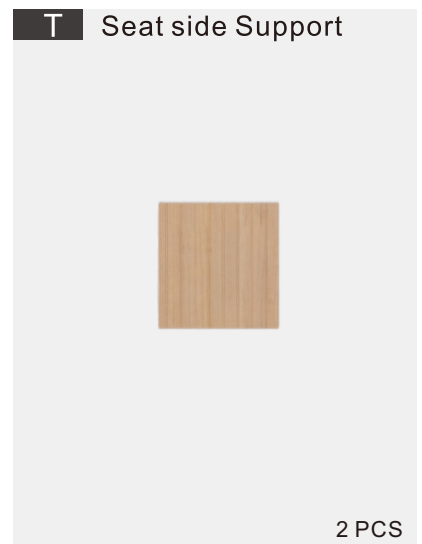
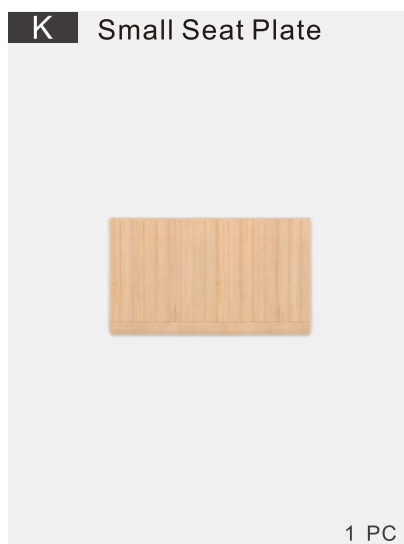
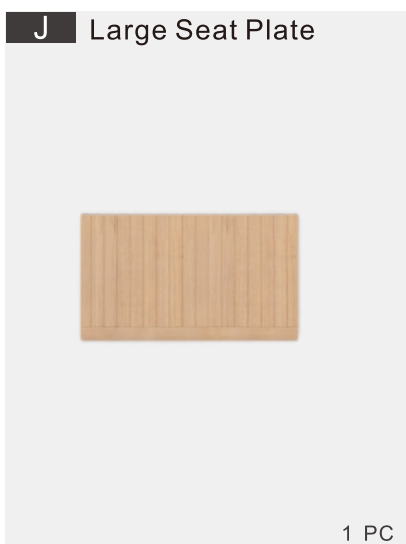

# Product Installation Steps

- The installation directions for the sauna room are based on the position of a person facing the sauna.
- Place the bottom panel on a level surface with the top side facing up.
- The installation position of the cup holder and towel rack is up to you.

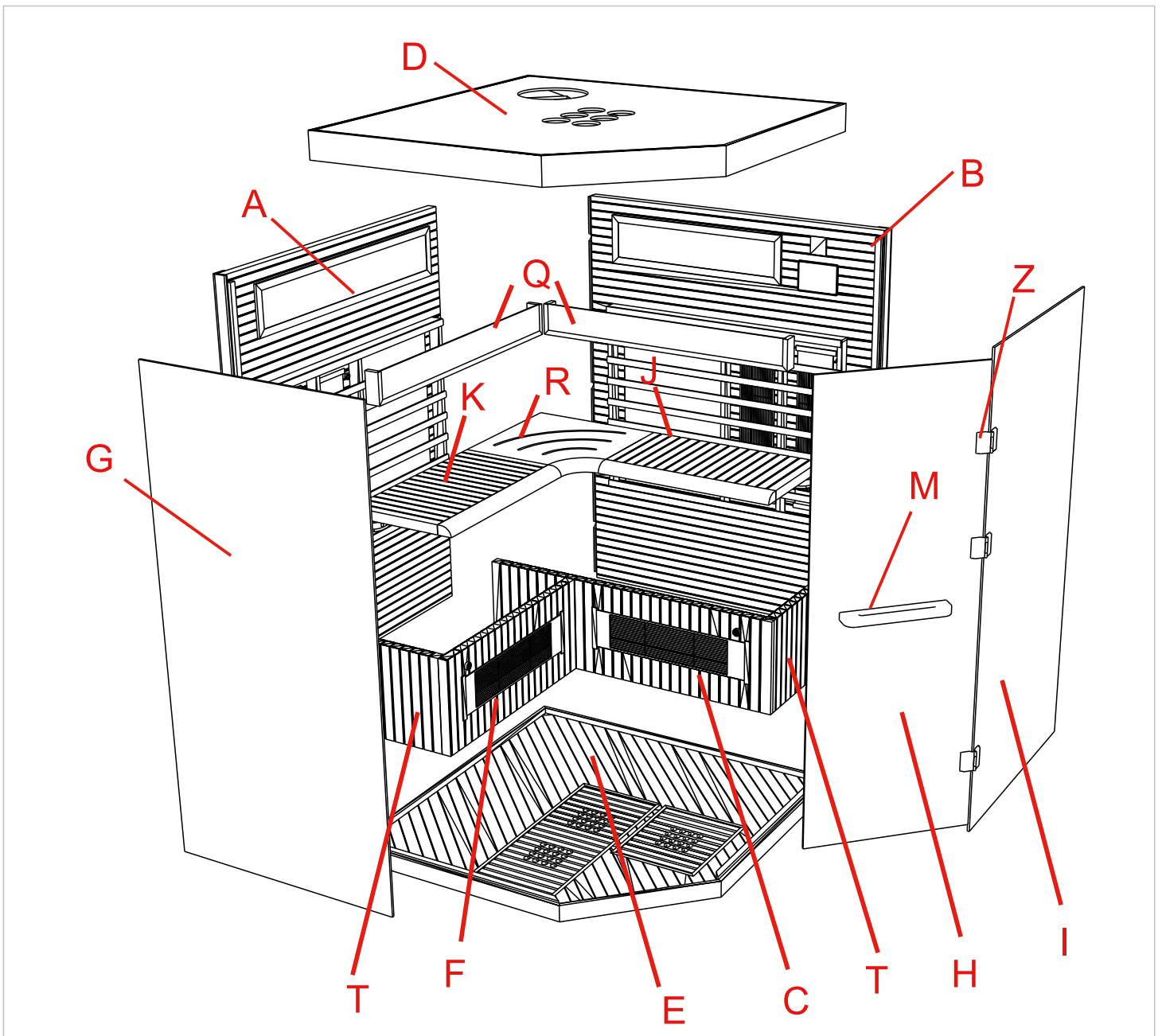

# I PRODUCT ASSEMBLY

- 1 Open sauna packages in a large area Place Bottom Floor Panel (E) on the desired location.

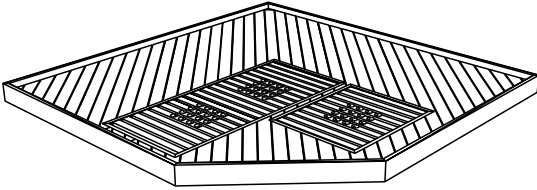

- 2 Install the left side back plate (A) on the base plate groove

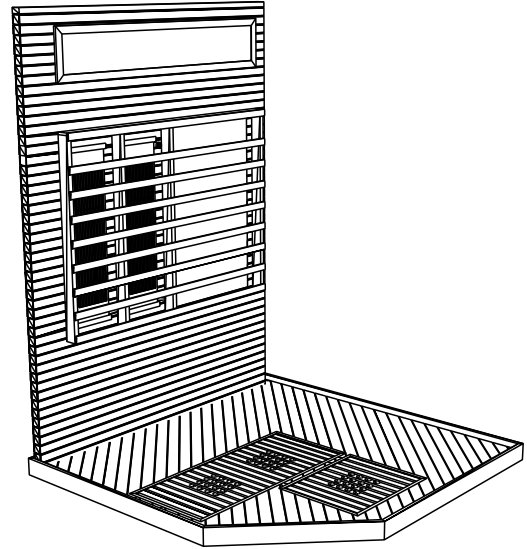

- 3 Install the right side back plate (B) on the base plate groove

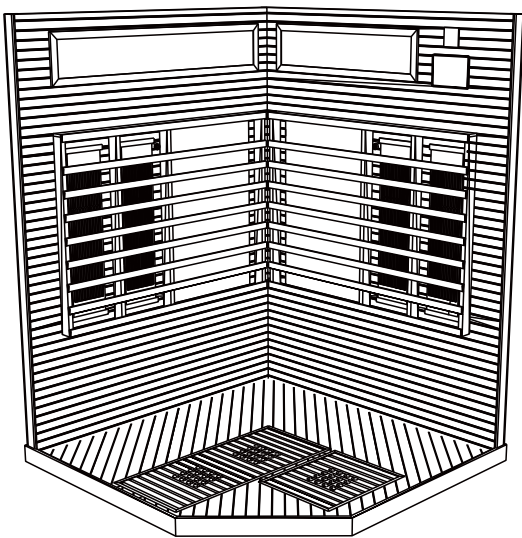

- 4 Secure the left and right side back panels with clasps

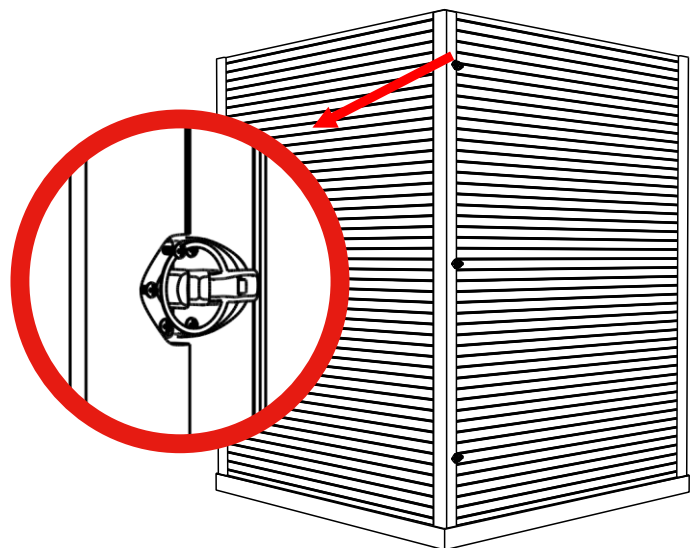

# I PRODUCT ASSEMBLY

**5** Remove the dust cover on the top plate (C)

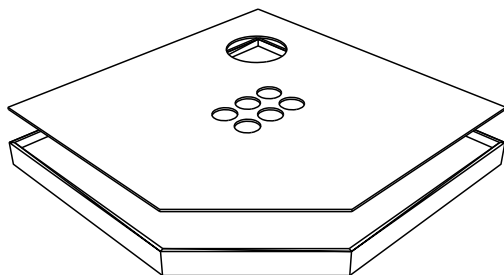

**6** Run the power cord from the house through the hole in the top plate and install the top plate on the house

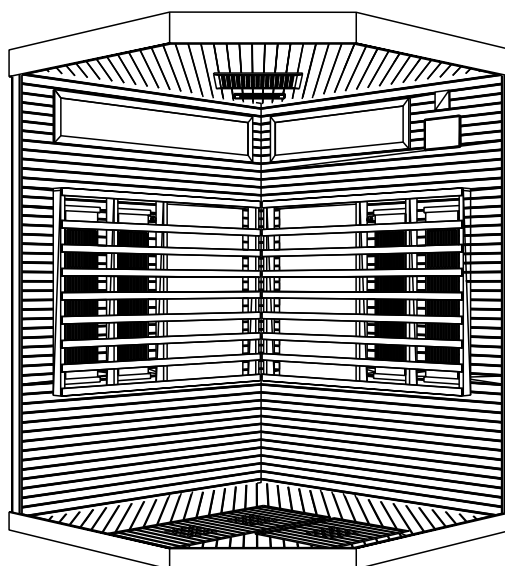

**7** Preparation before installing the glass: Remove the glass crimping strips (side, top, bottom)

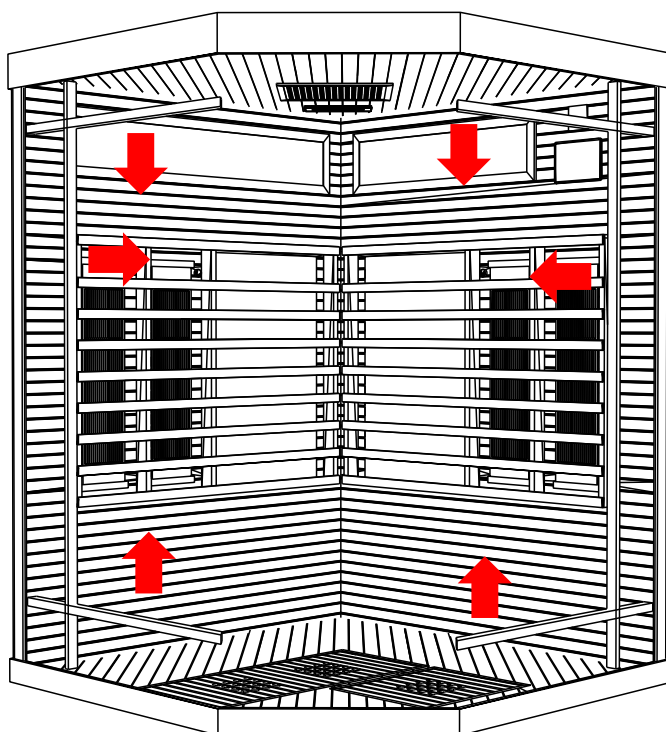

# I PRODUCT ASSEMBLY

- 8** Install the left and right glass (please note the distinction between G and I) and fix the glass with ST3\*20mm + spacer\*12pcs.

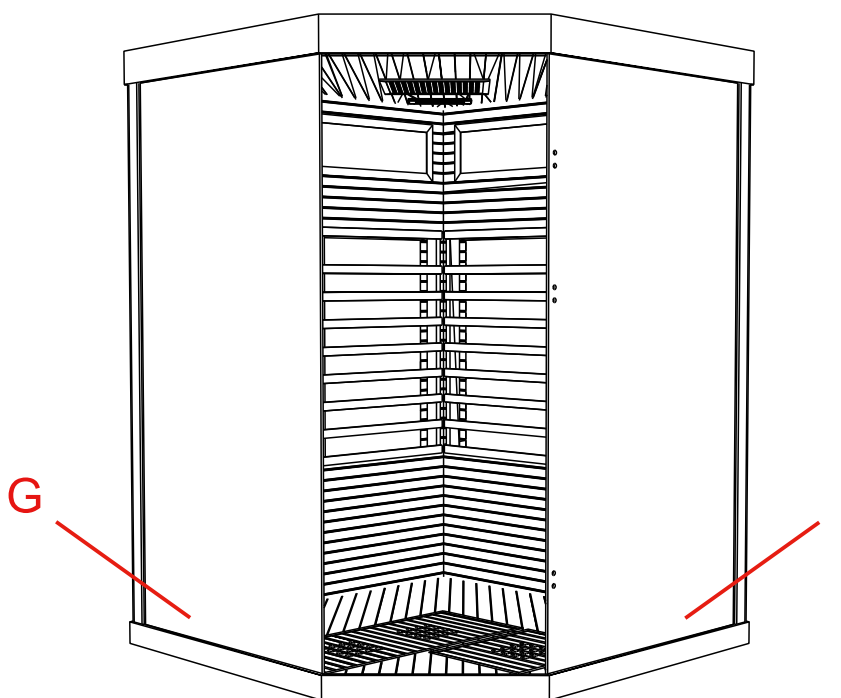

ST3\*20mm+Spacer

- 9** Install the glass fixing strip and fix it with screws (side ST3.5\*25mm\*10pcs, top+bottom ST3.5\*50mm\*12pcs)

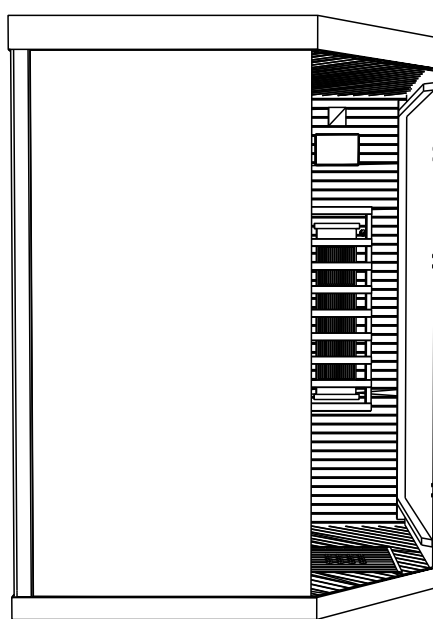
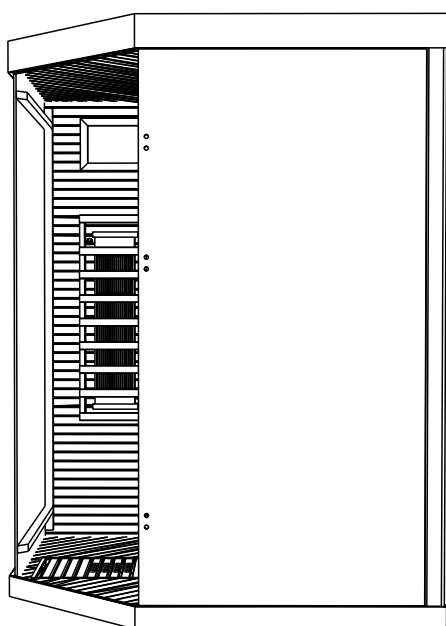

ST3.5\*50mm

# I PRODUCT ASSEMBLY

**10** Install the left and right side seat side support (T) and fix it with 3.5\*50MM\*4 screws.

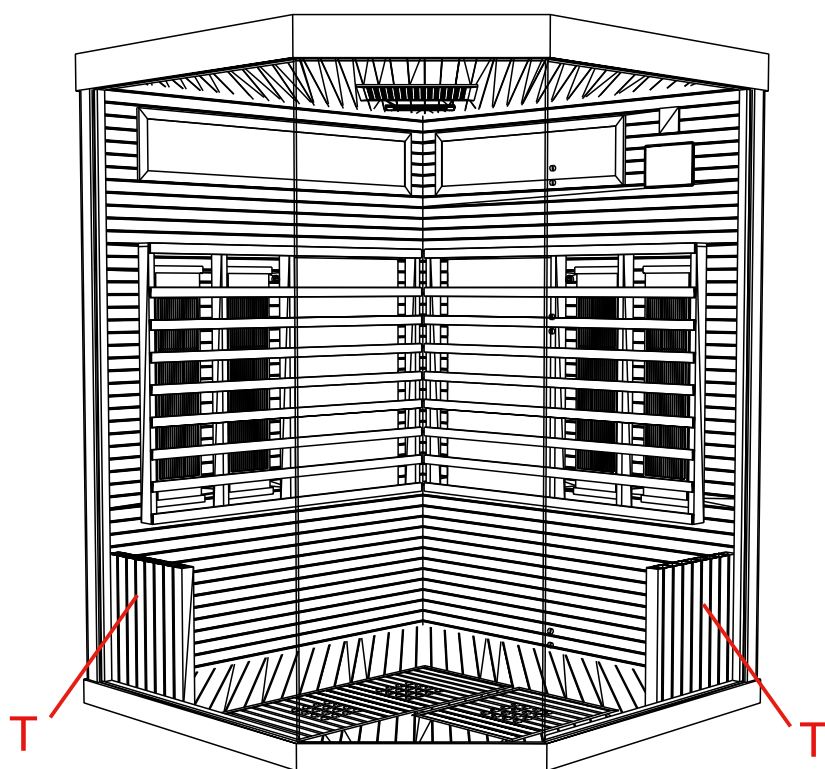

ST3.5\*50mm

**11** Install the left and right side seat supports (C and F) and fix them with 3.5\*50MM\*8 screws.

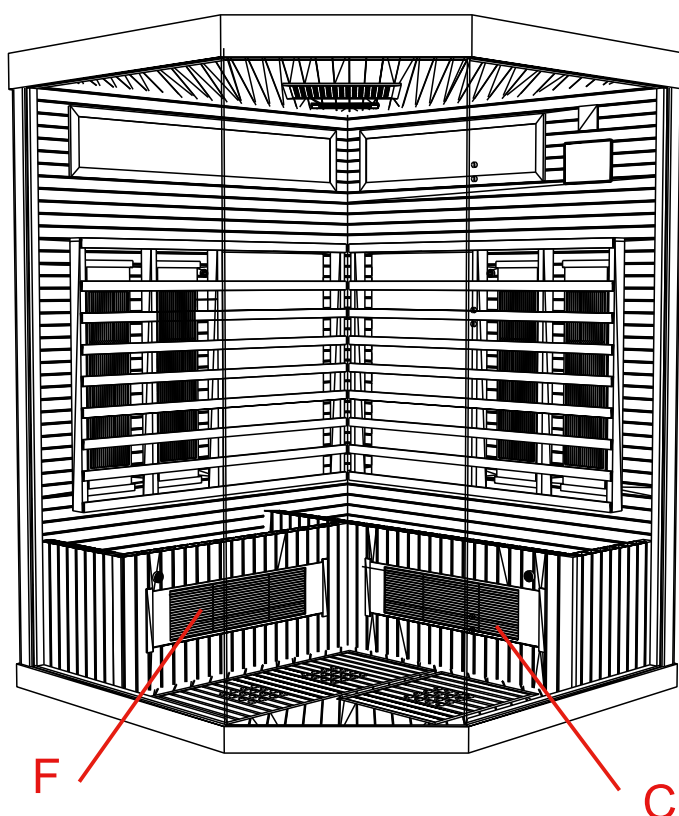

ST3.5\*50mm

# I PRODUCT ASSEMBLY

**12** Connecting the seat interior heater power cord (both seat interiors)

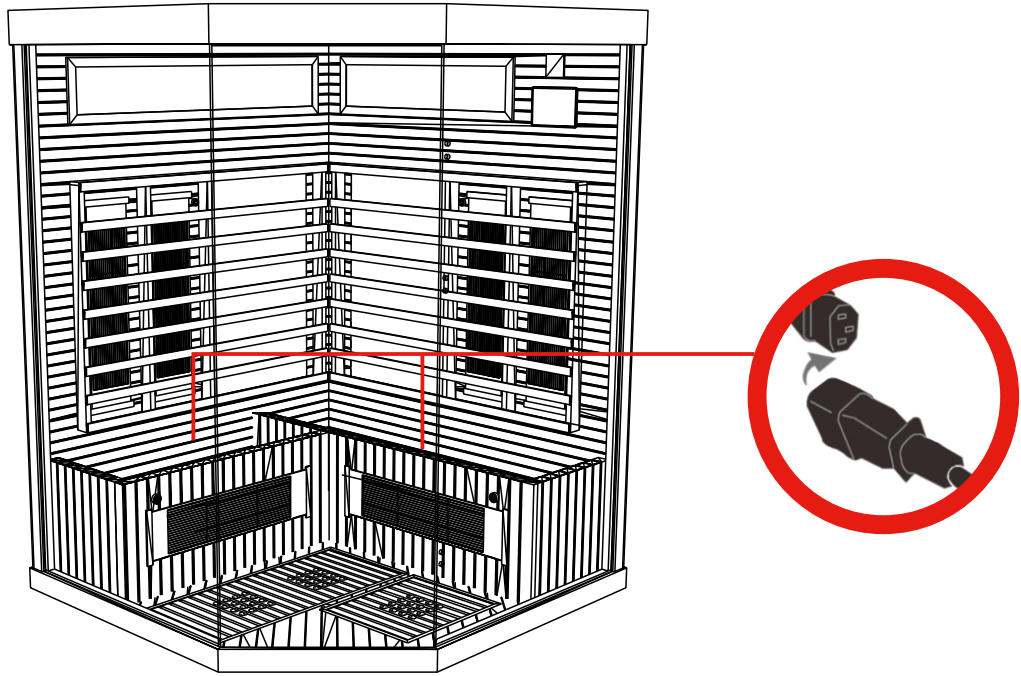

**13** Installation of three seat panels (J, K, R): connect the power cord of the light strip with the square seat panel, and then 3.5\*50MM\*6pcs screws to fix the three seat panels.

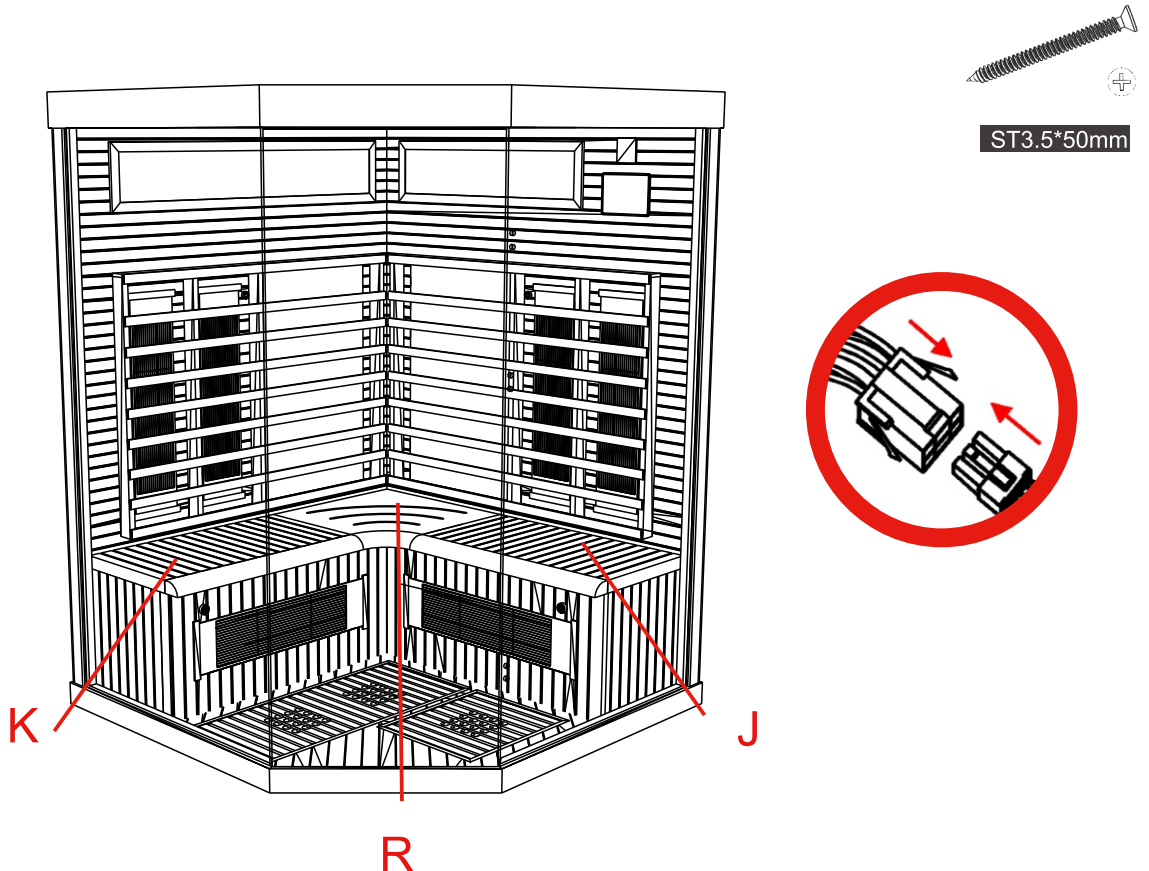

# I PRODUCT ASSEMBLY

- 14** Install the salt lamp (Q):
- ① Connect the salt lamp frame with the colorful lamp tape on the wall of the sauna room, and tuck the excess lamp wire into the inside of the sauna room.
  - ② Then hang the salt lamp frame on the sauna room board.
  - ③ Make sure the frame is hanging firmly, and then put in the salt grains (O).
  - ④ Repeat the steps to install another salt lamp when finished.

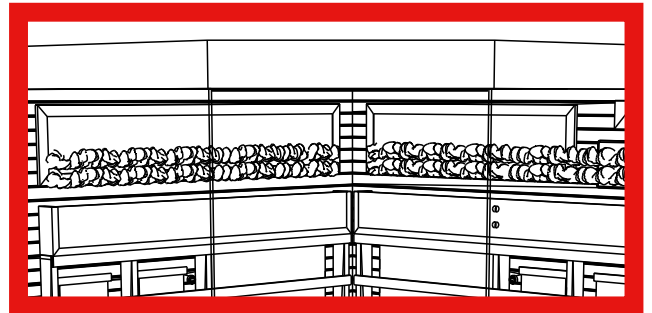
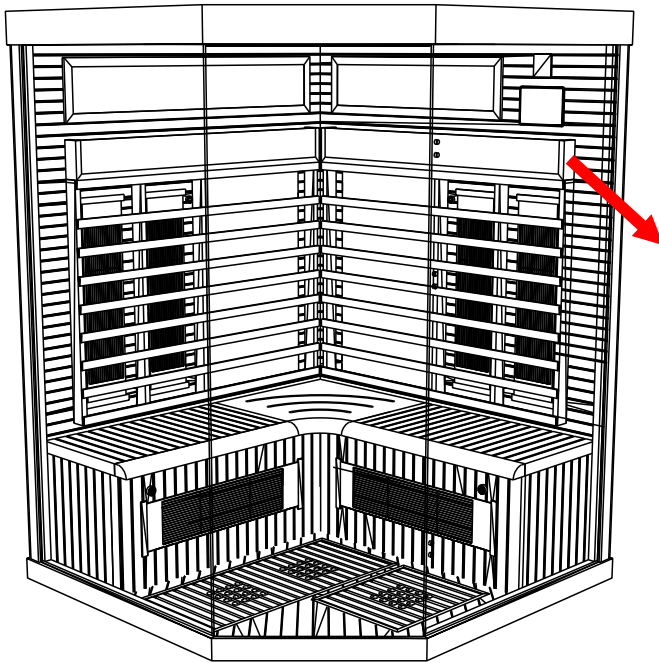

- 15** Fix the teacup holder (N) with ST3.5\*25mm\*4 screws in the room gap.

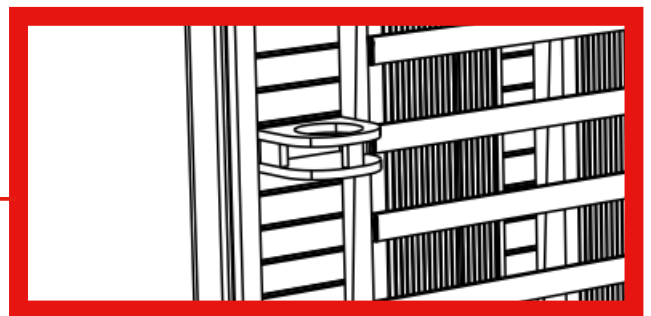
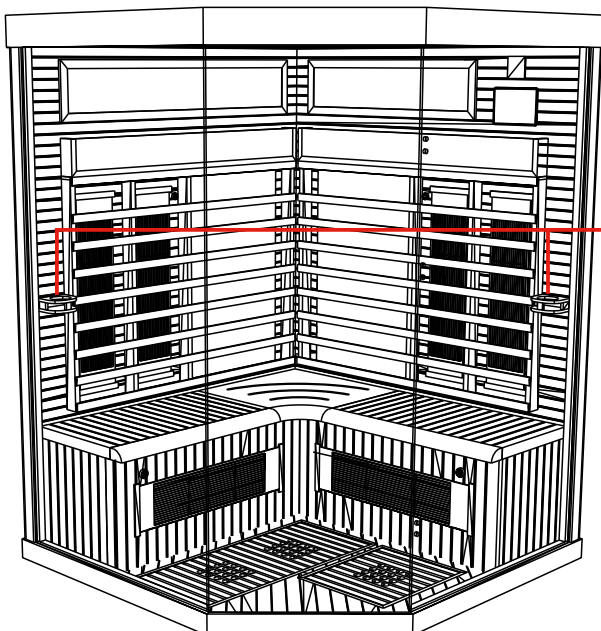

ST3.5\*25mm

# I PRODUCT ASSEMBLY

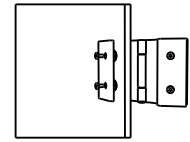

**16**

Install the door glass(H):

- ① Disassemble the hinge(Z).
- ② Install the hinge on the hole reserved for the right side glass.
- ③ Align the holes in the door glass with the hinge, and fix the glass door with the right glass.

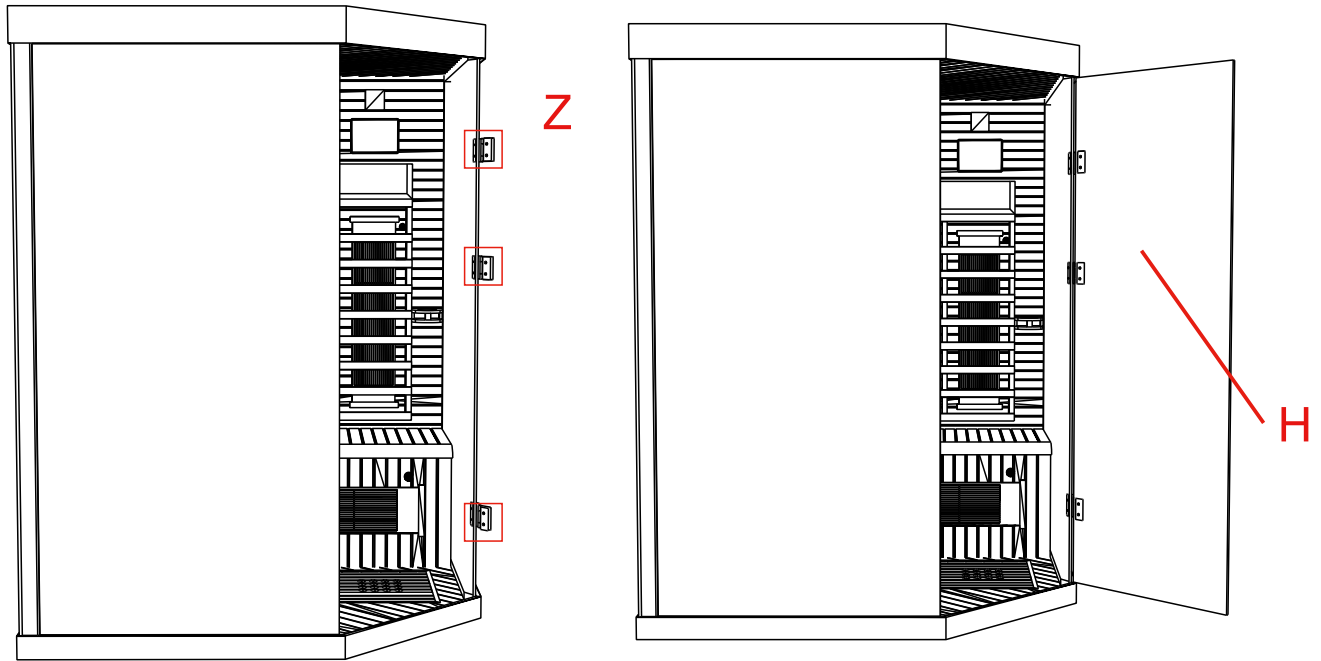

**17**

Installation of door handles (M+  $\phi 6*70\text{mm}$ \*2pcs)

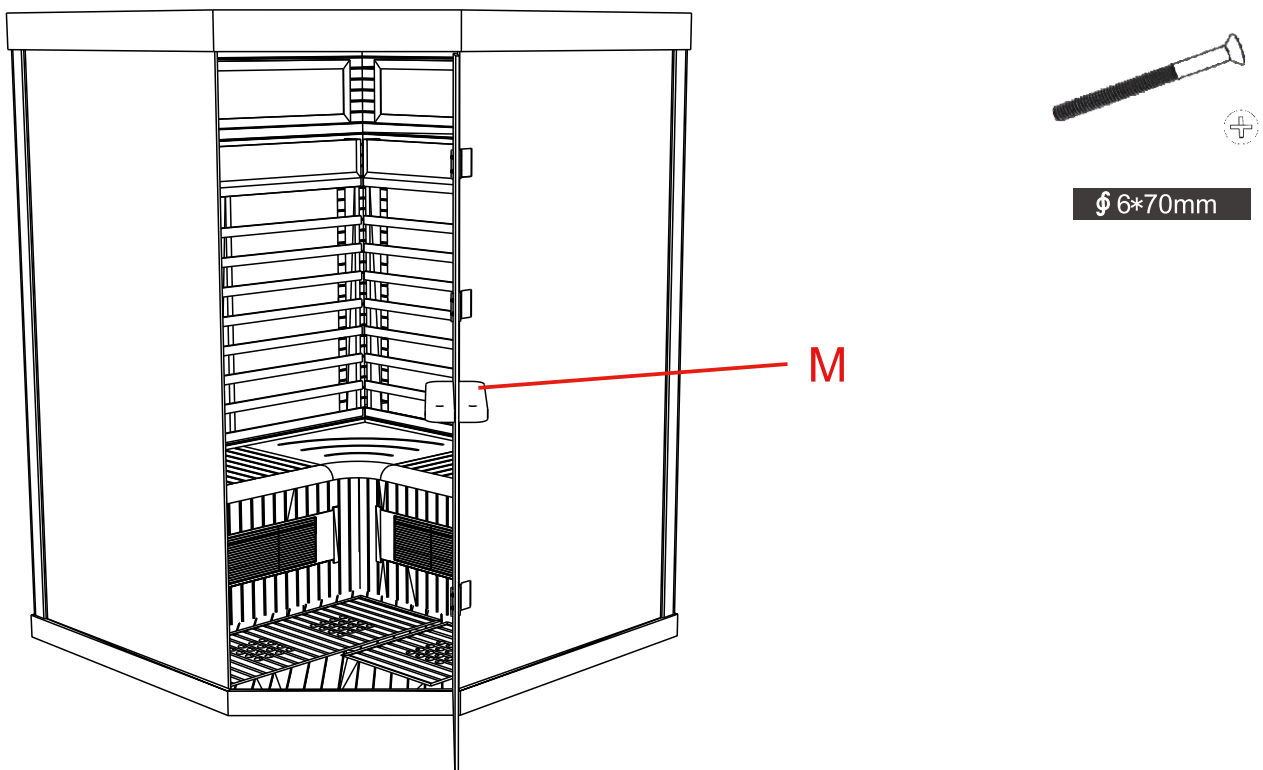

# I PRODUCT ASSEMBLY

- 18** Connect the top power cord  
Heater power cord\*4/  
Sauna control panel power cord\*1/  
Colorful light cord\*4/  
Speaker control cord\*1/  
Radio antenna\*1/  
Sauna light control power cord\*1/  
Light strip control cord\*1



- 19** Installation of dust cover: Put the sauna power cable through the hole of the dust cover, and then use ST3.5\*15mm screws to fix the dust cover on the top plate.

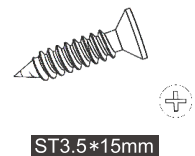
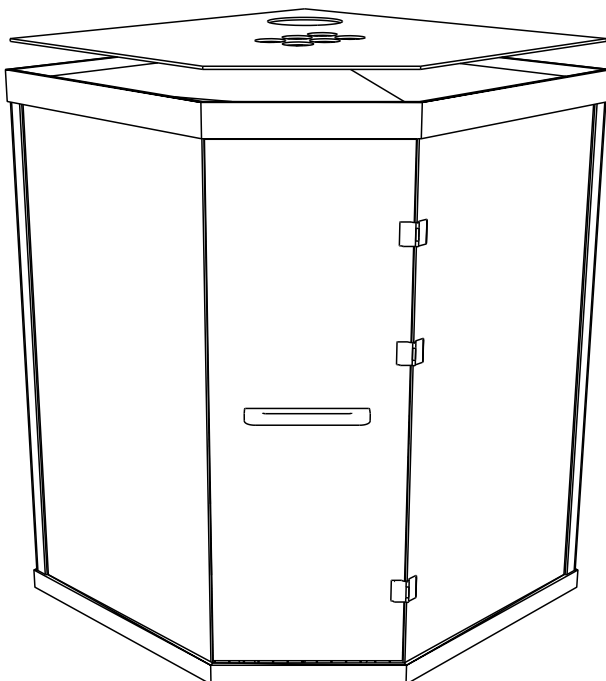

# I PRODUCT ASSEMBLY

## 20 Installation of glass seals\*5 (P)

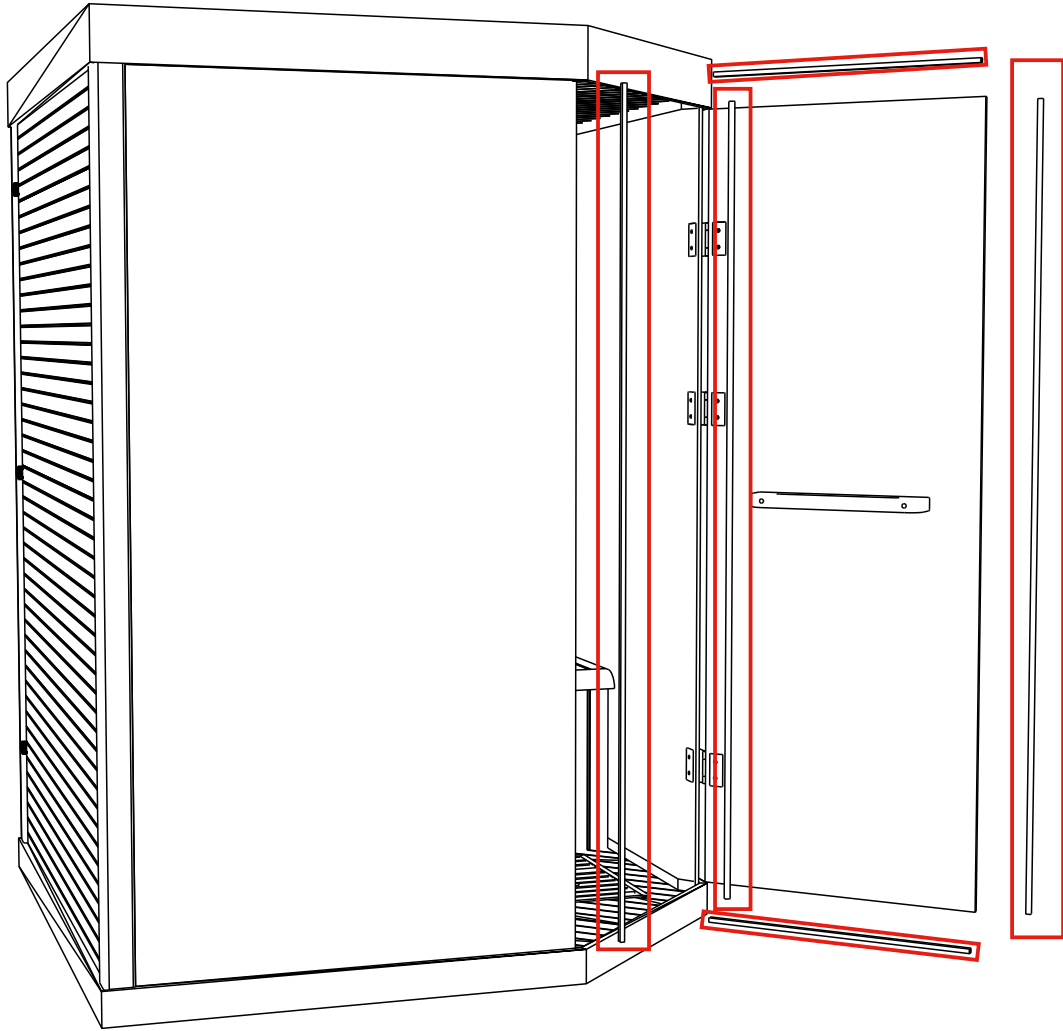

# Install the Oxygen Bar



## Oxygen Bar

- 1) Install the fragrance sheet into the back of the Oxygen Bar.
- 2) Install the Oxygen Bar.
- 3) Plug in the power supply.



## Oxygen bar operation instructions

### 1. Press the Ion button to release negative oxygen ions:

Negative oxygen ions can improve nervous system function, promote blood circulation and metabolism, relieve fatigue, enhance immunity, and purify air.

They have a positive impact on the cardiovascular system, dilating blood vessels and lowering blood pressure. Negative ions are beneficial for the respiratory system, increasing lung capacity and aiding in the treatment of respiratory diseases.

### 2. Press the Ozone button to release ozone :

Ozone in sauna rooms is primarily used for disinfection and odor removal. Ozone can effectively kill bacteria and viruses, break down organic compounds, and eliminate unpleasant smells, thereby purifying the air and enhancing the user's bathing experience.

**NOTE :** The anion and ozone functions operate independently; when the ozone function is activated, the anion generator will cease operation. Approximately after a 15-minute period, the ozone function will automatically shut down, subsequently reactivating the anion generator.

## E. OPERATION INSTRUCTIONS

Note: Before using the sauna, remove the plastic protective film from the control panel and check and confirm the power connections. Ensure that the power, heating element, and temperature sensor are connected correctly, and that the power voltage and frequency match the sauna's requirement (240V/15A Dedicated Circuit)

### Using the Sauna

Pull the temperature sensor vertically downward as shown in the image to ensure the accuracy of the temperature display on the control panel.



Insert the power cable into the wall socket.

**The sauna room plug: 240V/15A(6-15P)**

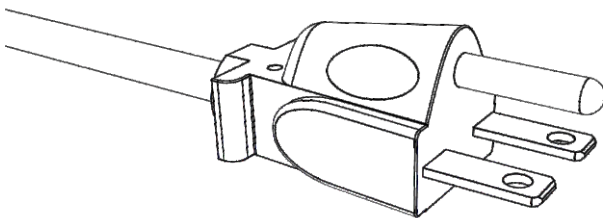

# Control Panel Operating Instructions



Serial No.	Function	Serial No.	Function
1	Power switch	8	Music button
2	Digital display	9	USB
3	Light button	10	Play/Pause
4	Temperature +	11	Previous track
5	Temperature -	12	Next track
6	Time +	13	Volume +
7	Time -	14	Volume -

- a. Press the power switch (1) to activate all internal electrical components, turn them on and put them into operation. For any electrical component with separate switches, if it is in the off position, each switch will need to be turned on individually.
- b. Press and hold Temperature + (4) and Temperature - (5) to toggle between Fahrenheit and Celsius temperatures.  
Press Temperature + (4) to raise the temperature and Temperature - (5) to lower the temperature.
- c. Light Button (3): Once the power is on you can control the top beauty light on/off.
- d. Press Time + (6) and Time - (7) to adjust the time, 5 beeps will be emitted when counting down 5 minutes; if the time display is 00, the sauna will stop heating.
- e. Press the music button (8) to switch modes:  
-The display (2) will show "FM".  
-Press again and "bLU" will be displayed. Turn on the Bluetooth function of your cell phone and search for "BT-AUDIO" for pairing and connection.  
-Press for the third time, "Off" will be displayed.  
-Insert the USB drive into the USB port (9) will switch to USB playback mode.
- f. When playing music, press Play/Pause (10) to pause or play the song. Press Previous (11) or Next (12) to adjust to the previous or next song. Press Volume+(13) or Volume-(14) to adjust the volume.

# Color Light Controller Operating Instructions

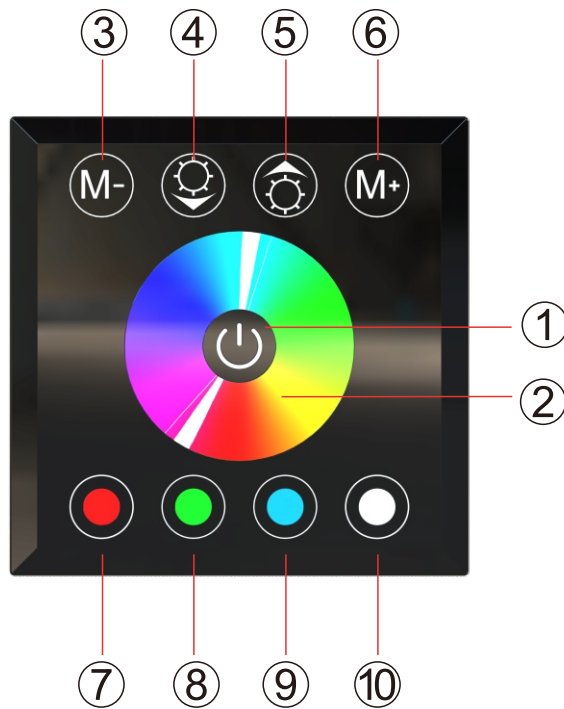

NO.	Function
1	Power switch
2	Touch color palette
3	Lamp mode-
4	Light Brightness-
5	Light Brightness+
6	Light mode +
7	Red light
8	Green light
9	Blue light
10	White light

**After powering on, the controller enters standby mode and the lamp does not light up;**

- Touch [(1) On/Off key], turn on the power, enter the monochrome mode, the red light is on, (if the last time you used [(3)M-] or [(6)M+], it will memorize the last mode);
- Tap [(3)M-Mode button] , change the mode: a. automatic color change slow change; b. monochrome “breathing” mode, at this time, press [(2) palette] to change the color. c. automatic “breathing” and color change slow change; in turn cycle.
- Tap [(6) M + mode key], you can change the mode: a. automatic color fast change; b. monochrome “breathing” mode at this time, press [(2) palette] can change the color. c. automatic “breathing” and color fast change (brightness plus or minus key has no effect); in turn cycle.

- The lighting modes of [(3)M-Mode Key] and [(6)M+Mode Key] are in order: “Monochrome Red” --- “Color Change (Brightness Plus and Minus Keys have no effect) ‘Monochrome Breathing’ --- ” Color Change + Breathing” (Brightness Plus and Minus keys have no effect) --- in turn cycle.
- Optional colors in “Monochrome” and “Breathing” modes are not adjustable for brightness.
- The lower row of color keys are single color, (7) red, (8) green, (9) blue, (10) white.
- Press [(4)Brightness Decrease] [(5)Brightness Increase] key to adjust the brightness of the light in monochrome mode (note that gradient color, brightness increase or decrease does not work)

**Note:**

- 1. Color change means: light color change.**
- 2. Breathing refers to: light brightness changes.**
- 3. [(3)Mode minus] and [(6)Mode plus] are just different speeds of color change and breathing, but the others are the same.**



## Relieve eye and face discomfort

### COLD COMPRESS

Simply store the mask in the freezer at  $-18^{\circ}\text{C}$  or lower temperature. For better effect, the best freezing time is 2-6 hours.



Puffy eyes



Dry eyes



Stressed



Cosmetic surgery recovery

### HOT COMPRESS

Heat the mask in microwave in 10-15seconds intervals until desired temperature is achieved the maximum heating time does not exceed 30 seconds.

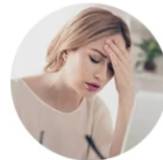

Migraine



Toothache



Eye fatigue



**Ice:** Put the ice ball in the freezer (about 30 minutes) before use, remove the water and wash it before use

**Hot:** Soak in hot water (about  $55^{\circ}\text{C}$ ) for two minutes, remove it and wipe off the water droplets.

Before massage, it is recommended to apply an even layer of water massage cream (or roller serum) to the skin, and then operate as shown in the picture

**Lifting technique**

Starting from the neck, gradually lift and massage from the bottom to the top, repeating 4-5 times with gentle and moderate pressure to tighten the skin and create a V-shaped face  
Suitable for: sagging, obesity, dry fine lines and other skin.

**Nourishing technique**

Starting from the lower jaw, massage from the bottom to the top, using the hockey ball rolling clockwise from the outside to the inside, and tap the acupressure points around the face and eyes to stimulate cell vitality and promote product absorption.  
Suitable for: Wrinkled skin, eye bags, dark circles and other eye problems.

**Massage technique**

Starting from the forehead, roll the puck from the inside to the outside and start from the center of the upper and lower lips, moving the corners of the mouth in a counterclockwise circular motion  
Suitable for: Lifting and firming and enhancing facial muscles to restore elasticity.



The ergonomic design fits the human back, neck and other parts that can effectively relax muscles or hard-to-reach parts, relieve muscle stiffness and relieve fatigue.



Head massage



Foot massage



Back massage



Buttock massage

# F. RECOMMENDATIONS FOR USE

## 1. Preparation Before Use

- **Hydrate Appropriately:** Since using a sauna room can cause profuse sweating, it is recommended to drink an adequate amount of water before use to replenish body fluids.
- **Choose Suitable Clothing:** It is best to wear light and breathable clothing to facilitate sweat evaporation and body cooling.
- **Prepare Towels and Loose Clothing:** Bring a towel for wiping sweat and prepare a set of loose clothes to change into after use.
- **Warm-Up Time:** Allow approximately 8-15 minutes for the sauna to warm up.

## 2. Control of Temperature and Time

- **Gradually Adjust Temperature:** For first-time users, start with a lower temperature and gradually increase it as you become more accustomed.
- **Control the Usage Time:** For beginners, each session should not exceed 15-20 minutes, and as adaptability improves, it can be gradually increased to over 30 minutes.

## 3. Scheduling Frequency

- **Adjust Frequency Based on Needs:** If the goal is weight loss or detoxification, you can use it twice a day; if it's for relaxation and health maintenance, using it 2-3 times a week is sufficient.

## 4. Precautions During Use

- **Avoid Using Immediately After Meals:** Wait at least half an hour after eating before using the sauna to avoid affecting the blood supply to the digestive system.
- **Avoid Use When Overtired or Hungry:** The body's tolerance to temperature decreases in these states, which can easily cause discomfort.

## 5. After Use

- **Promptly Replenish Water and Nutrients:** After use, promptly replenish water and electrolytes, and you can consume some minerals-rich foods.
- **Rest Before Resuming Activities:** Since the body has been exposed to high temperatures, it is advised to rest in the sauna for a while before engaging in other activities.

**Additionally, here are some special attention items and details that might be overlooked:**

- Patients with high blood pressure and heart disease should use it cautiously and preferably under the guidance of a doctor.
- Pregnant women should consult a doctor before use to avoid high temperatures affecting the fetus.
- If you feel dizzy, nauseous, or any other symptoms of discomfort during use, you should immediately leave the sauna and seek help.

## IMPORTANT SAFETY&OPERATIONAL CAUTIONS

Before utilizing the sauna, it is imperative to thoroughly familiarize oneself with all safety instructions and warnings as delineated in this manual and those affixed directly to the sauna unit itself. Comprehensive understanding and adherence to these safety guidelines are critical for ensuring the safe and proper operation of the sauna.

# G.CAUTIONS

## 1. Unsuitable Users

- a) Do not use the sauna if you have open wounds, eye diseases, serious burns, are elderly, frail, pregnant, or have specific health conditions like hyperthermia, obesity, heart disease, hypertension, or diabetes without consulting a doctor.
- b) Excessive temperature has a high potential for causing fetal damage during the early months of pregnancy. Pregnant or possibly pregnant women should contact their physician prior to using the sauna.
- c) Do not use the sauna immediately following strenuous exercise. Wait at least 30 minutes to allow the body to cool down completely.
- d) Do not bring pets into the sauna.
- e) Avoid using the sauna after excessive alcohol consumption.
- f) The sauna is suitable for children aged 6 and above, and individuals with reduced physical, sensory, or mental capacities, provided they are supervised or instructed on its safe use and understand the potential hazards.

## 2. Precautions for Operation

- a) Dry your hands before handling electrical controls. Never unplug the power cord or adjust the controls with wet hands or when you have wet bare feet. A danger of electrical shock exists.

- b) Allow up to 30 minutes heat up time.
- c) Always stay hydrated while using the sauna.
- d) Do not touch the heater tube with hands or metal objects to prevent burns and damage.
- e) Avoid touching lights when they are on to prevent electrocution and damage.
- f) Avoid splashing water or liquids on the heater tube to prevent electrical faults.
- g) Supervise children to prevent them from playing with the sauna appliance.
- h) Do not cover the heater or infrared emitter as it poses a fire risk.
- i) After 2 hours of continuous use, shut the sauna down for one hour.
- j) Beware of exhaustion and sauna usage.
- k) Inspect the sauna room before restarting the timer.

### **3. Sauna Modification**

- a) Altering or tampering of any electrical connections on the power supply will void the warranty.
- b) Do not modify, cut, or alter the provided power cord as it is specifically designed for safe operation. Any unauthorized changes may void the warranty and introduce safety hazards.
- c) Avoid using extension cords with this product. They can cause voltage drops, leading to decreased performance and potential safety risks. For extended coverage needs, contact customer service for recommended solutions. Non-compliance will result in a voided warranty and personal responsibility for any issues.
- d) The door of the sauna should not include any locking or latching systems that could cause entrapment in the event of a malfunction.

### **4. Damage and Repair**

- a) If the power supply cord becomes damaged ensure power is off, cable is unplugged and retailer is contacted. It must be replaced by the manufacturer, service agent, or a similarly qualified person to avoid hazards.
- b) DO NOT attempt any repair without consulting SaunaEra first. Unauthorised repair attempts will void warranty.
- c) Always unplug your sauna from the wall outlet before servicing.

- d) Please contact SaunaEra for replacement parts if required.

## 5. Sauna Work Environment

- a) DO NOT stack or store any object on top of or inside the sauna.
- b) Avoid drying clothes or leaving towels in the sauna to prevent fire risks.
- c) This product is a dry steam sauna room. Place it in a dry area, ensuring a minimum 1-inch gap between the sauna room bottom and the floor for ventilation. Do not place on blankets or materials that may block ventilation.
- d) When fitting your sauna, do not push the door; ensure it opens outward to avoid obstruction.

## 6. Electrical Safety Warnings

- a) Power line connections must be installed by a professional electrician.
- b) Do not cover the heater as it poses a fire risk.
- c) Ensure all power circuits are disconnected before accessing terminals.
- d) Check all the circuitry and the plug connections carefully.
- e) Install a voltage regulator if the power is unsuitable.
- f) Do not share the outlet with other electrical appliances to avoid danger.
- g) No electrical receptacles should be installed within the sauna.

**NOTE: All natural wood articles have variations in the color, grain, and irregularities such as knots, and fine cracks. These characteristics are a part of the natural beauty of the wood, and in no way should be considered defective.**

## H. CLEANING & MAINTENANCE

Before using your sauna for the first time, clean the inside of the sauna with a damp cloth.

If the smell of the sauna is strong at first, that is normal and please open the door while the sauna is working. The smell will diminish over time.

- (1) DO NOT use any type of cleaning agents on the interior of the sauna.
- (2) The sauna room should be kept clean and odor free.
- (3) We recommend placing a soft towel on the floor and on the bench of the sauna to absorb

perspiration during sauna use.

- (4) Saunas that are in daily use should be washed down at least once a week to keep them clean and the air fresh.
- (5) Air out the room often by keeping the door and vents open when the room is not in use.
- (6) To clean and remove perspiration stains, use soap or detergent in warm water, best applied with a scrub brush
- (7) Unplug the sauna from the wall outlet before cleaning DO NOT use liquid cleaners or aerosol cleansers inside the sauna. Use a clean damp cloth for cleaning.
- (8) Scratches and stains on the sauna can be removed by simply using fine grade sandpaper over the damaged area.
- (9) Cleaning and maintenance should not be performed by children without supervision.

## I. TROUBLESHOOTING

Ensure the power is turned off before proceeding. If the power cord is damaged, it should be replaced by the manufacturer, its service agent, or similarly qualified individuals to prevent any safety risks.

### 1. The infrared heaters are out of order

Phenomenon	Possibility	Repairing Method
One of heaters cannot heat.	The heater is not connected properly	Check connection
	The heater needs replacement	Replace heater
All heaters cannot heat.	The power plug is not connected properly	Check power plug
	The heaters are not properly connected	Fix the connections
	Relay malfunction	Change relay
	Control panel malfunction	Change control panel

### 2. The control panel is out of order

Possibility	Repairing Method
The cable of control panel is not connected well.	Check the cable connection and fix it properly.

The fuse is burned up.	Change a fuse. On the top of ceiling
The indicator light of power is on, but no led display	Most likely will need a new control panel

## J. WARRANTY

1. Please fill in the warranty card on the following page within 30 days to register your sauna and receive a full warranty

We guarantee our sauna against defective material and/or workmanship for a period of 12 months from the purchase date. We warranty the replacement of heaters and any electronic components associated with the sauna for the life of the sauna to its original purchaser. Variations in wood texture, color, and normal wear are not covered by any warranty. We do not warranty the CD/DVD/LCD System as it carries its own manufacturer's warranty. The warranty is deemed void if the sauna has been misused, altered, or open to the elements of weather. Any deviation from the instruction manual causing damage to sauna will not be under warranty. Our Saunas and any of its subsidiaries and/or associates shall not be held responsible for any misuse of the sauna by customer. Our Saunas shall not be liable for any damage and/or injury caused by customer misuse of product. Customers shall use sauna at their own risk. Conditions are subject to change without notice.

2. Any damages sustained to sauna set during transportation are not covered by this warranty. Claims for damage must be filed through transport/shipping Company. Any damage must be reported on the Bill of Lading through transport shipping company.

3. You're welcomed to give us suggestions.

## **DISCLAIMER**

Our Saunas and its associates do not provide medical guidance. Consult a doctor for medical advice.

All of the information contained in this manual is for information purposes only. We reserve the right to change, without notice, anything contained within the manual. Our Saunas shall not be held responsible for printing variations. Color variations may occur. Some models are shown with optional features.

**WARRNATY CARD**

Model No			
Owner's Name		Telephone	
Address			
Dealer's Name			
Purchase Date		Installation Date	
Installation Status			
Signer: _____			
Remarks			

If reading through this manual and following the instructions has not resolved your issue, please contact SaunaEra:

**EMAIL**

SERVICE@SAUNAERA.COM

SERVICE@MEISSALIVVE.COM