

# Assembly Instructions

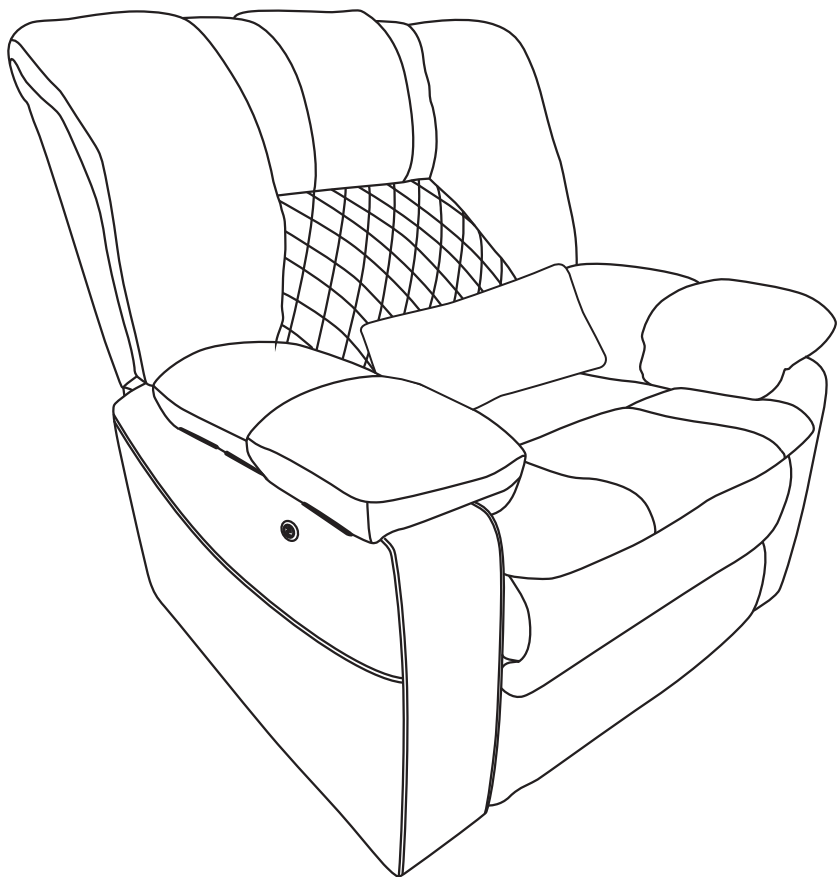

THIS INSTRUCTION BOOKLET CONTAINS **IMPORTANT** SAFETY INFORMATION.  
PLEASE READ AND KEEP FOR FUTURE REFERENCE.

---



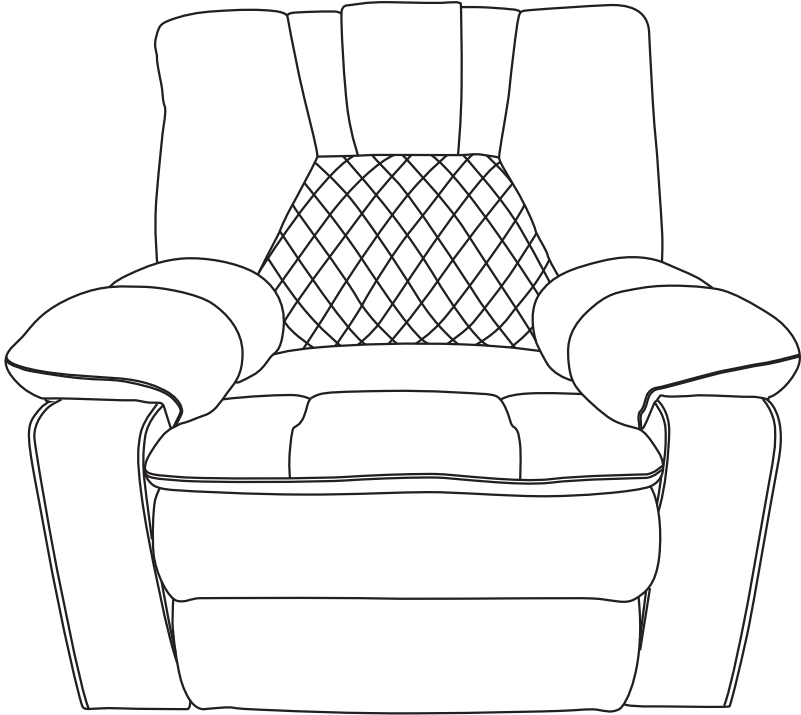

## GENERAL ASSEMBLY INFORMATION GUIDE

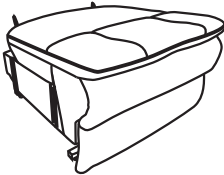
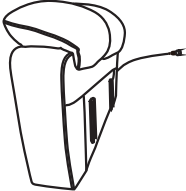

Please read the following instructions prior to assembling this product:

1. To avoid damage, assemble this product on a non-abrasive surface such as carpet.
2. Make sure all bolts are tightly fastened before use.
3. For home use or light commercial use only.
4. Please make sure you have all parts before assembly.

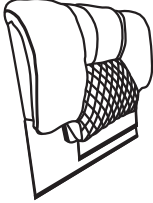
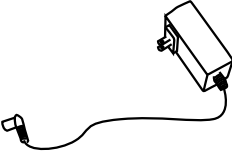
# Package Contents

|  |   |   |  |
|--|---|---|--|
|  |  |  |  |
| A1*Chair Seat  | B1*Left Armrest   | C1*Right Armrest  | D1*Backrest  |
| <b>Box1</b>  | <b>Box2</b>   |   | <b>Box3</b>  |
|  |  |   |  |
| E1*Power Supply  | F1*Remote Control Panel   |   |  |

Please find the spare parts at the bottom of the seat(Box1).

**Step 1** Remove this hardboard before assembly.

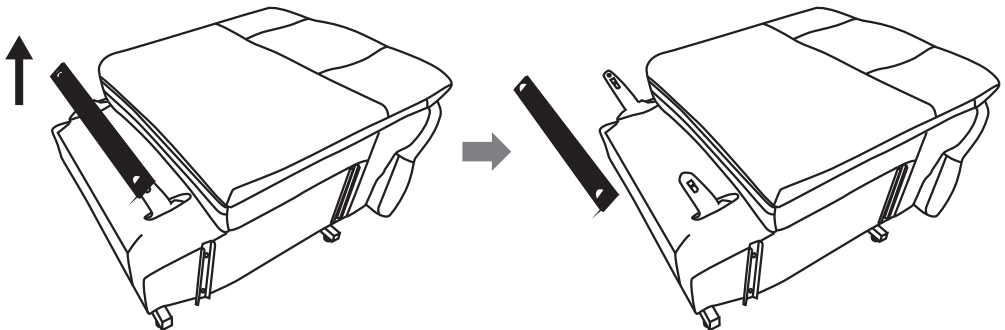

**Step2** Assemble the armrests.

Connect the Armrests(B&C) to the chair seat(A) by aligning the metal grooves and sliding down to the bottom.

PS: Pls ask another adult to pull the top cushion of the seat aside so that you can see clearly the metal grooves, it will be easier to make it, pls align the front metal groove first instead of the back one.

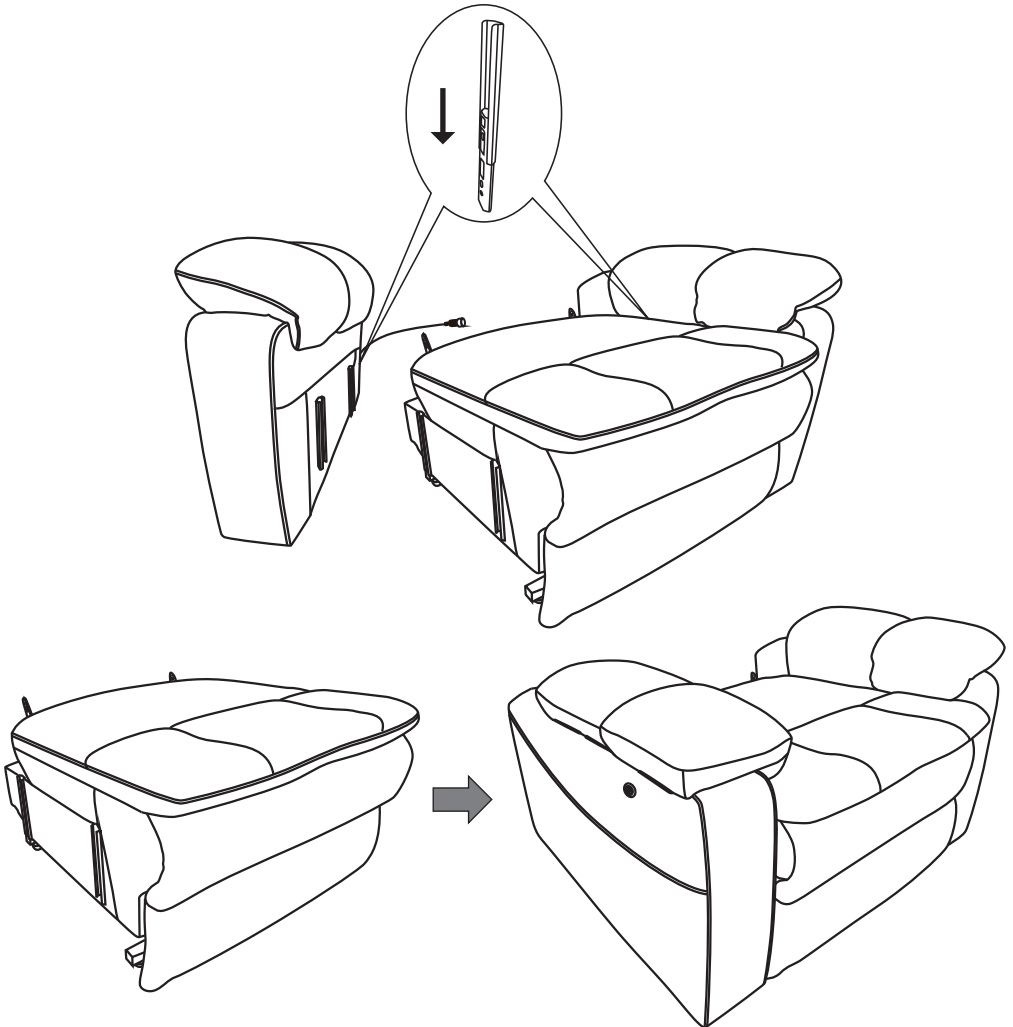

### Step3

Connect the chair backrest(D) to the chair seat(A) by aligning the metal grooves(M&N) and sliding down to the bottom.

PS: If the metal groove M slides down to the bottom of metal groove N, the backrest will not be taken off easily.

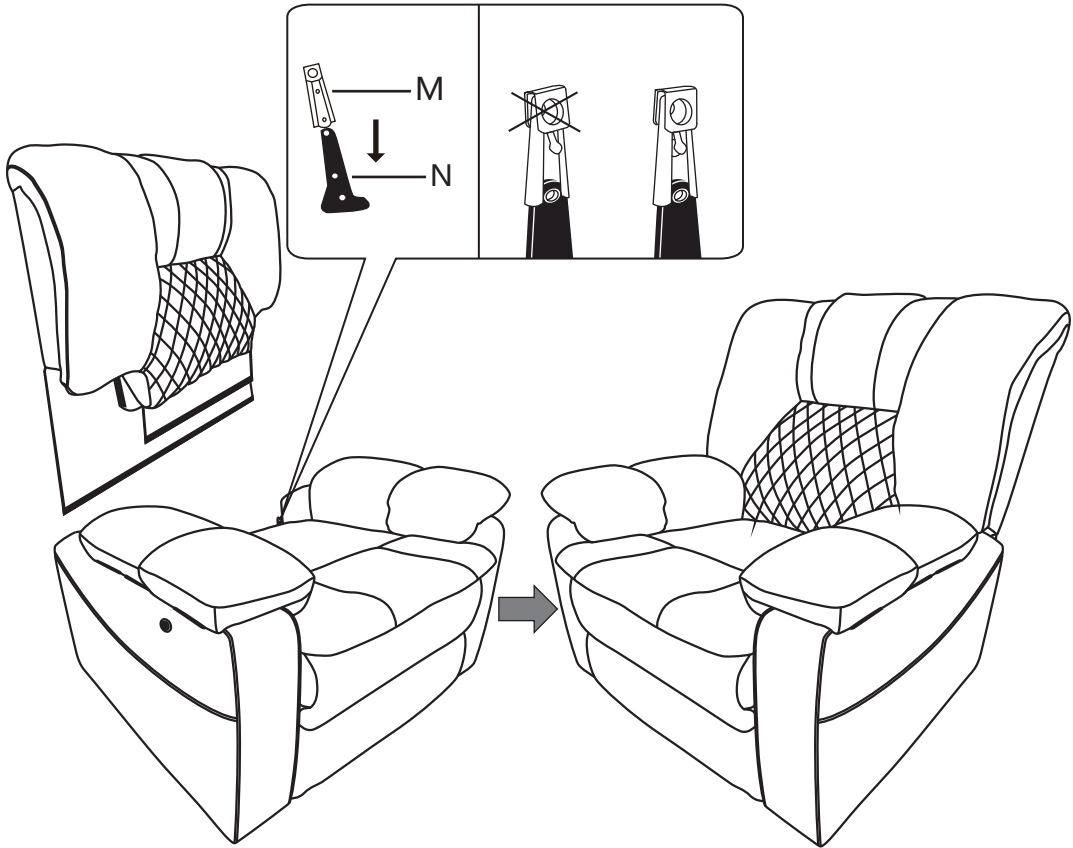

---

## Step4

Because the backrest is filled with doll cotton,3cm difference is allowed,and you can slap the higher part to align the backrest.

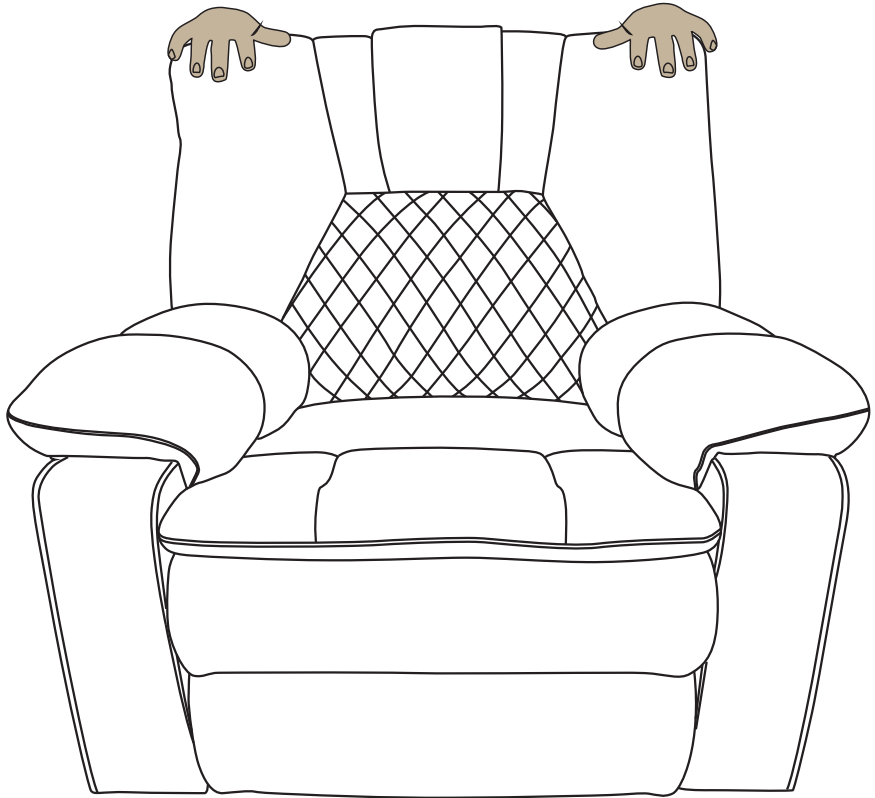

---

## Step5

You can find the hidden cup holder and storage design under the armrest.

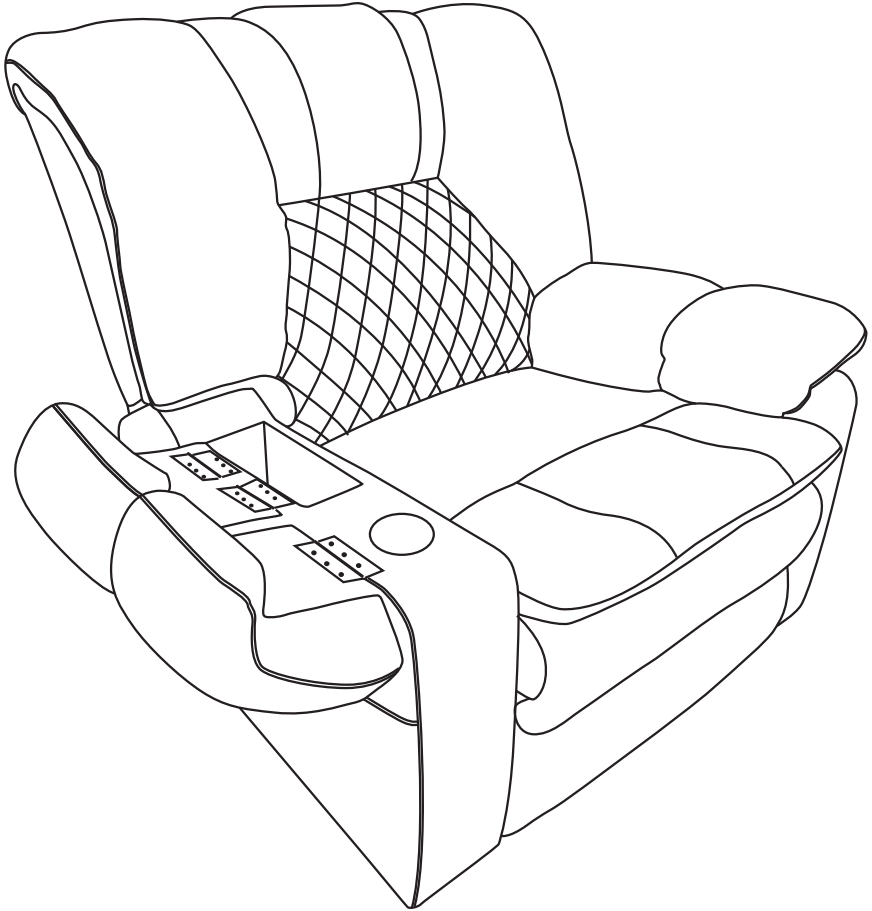

## Instructions for Connecting Power Cords

Pls be sure the wires with the same color are connected.

Tip: Lines of the same color must be connected. If the wires with different colors are connected, it can not work.

1. Cable No.1 is connected to the interface extending from the armrest, which is used to control the airbag massage and heating functions.

2. Cable No.2 (from the bottom of recliner) is connected to the remote(F) to control the motor functions.

3. There are two interfaces for Cable No.4, one interface is connected to Cable No.3 (from the backrest) and the other interface is connected to Power supply(E).

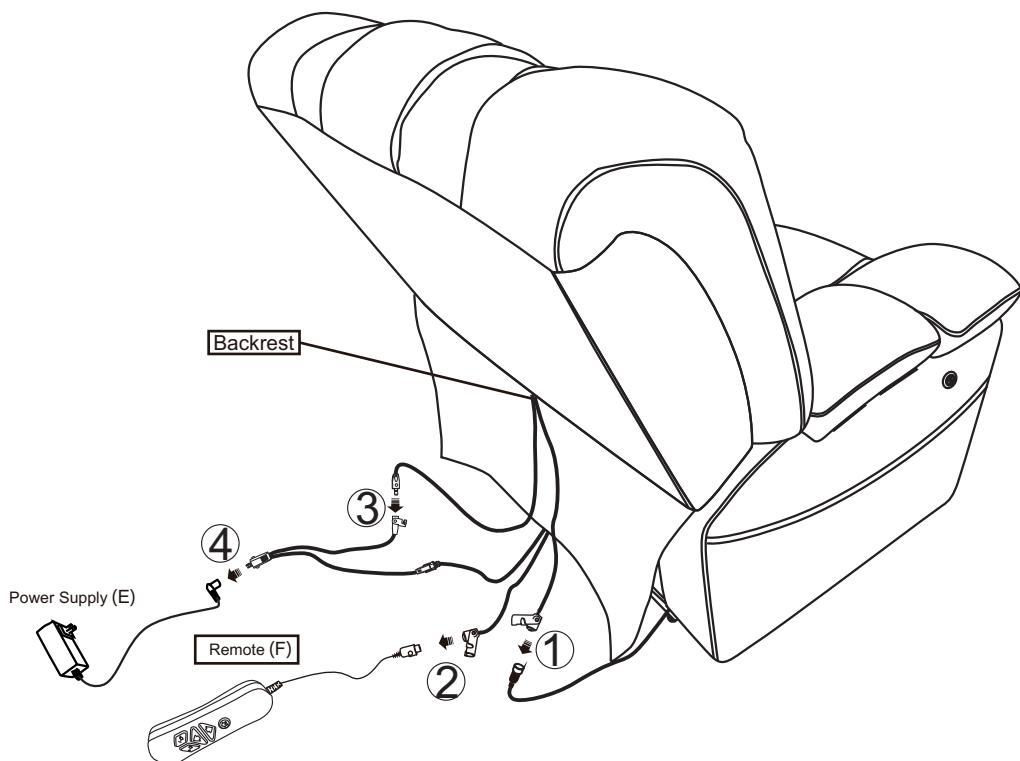

### Note:

1. Plug the Power Cord and Power Source into the outlet to get the recliner working.

## Instruction for Remote control

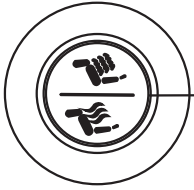

- Press and button once to activate the airbag massage; the indicator light will turn white.
- Press and button for the second time to enable the heating function; the massage function will be deactivated automatically.
- Press and button for the third time to enable the airbag massage and heating functions simultaneously.

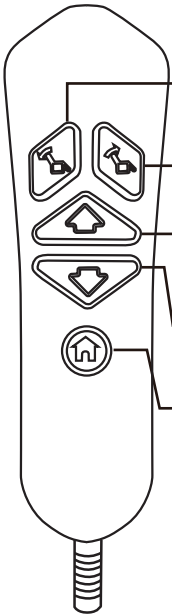

There are 5 buttons in remote control.

- Press and hold the button to extend the backrest.
- Press and hold the button to restore the backrest.
- Press and hold the button to restore the footrest, then the recliner will stand up smoothly.
- Press and hold the button to extend the footrest or restore the recliner from the standing status.
- Press and hold the button to restore the recliner to the standing status.

# Warnings

1. Please check if the chair's components are all included and can be used generally as the 6th tip.
2. Follow instructions and assemble all components correctly before connecting the chair with the power.
3. Please DO NOT sit on the armrests or footrest to eliminate the risk of tipping over.
4. Please be careful when lifting to avoid sliding from the chair.
5. If the chair you received is damaged or doesn't with the website, please send clear pictures of the product, and take a picture of one side of every outer box. (This side is printed with a camera pattern). Then send us these photos or videos, and we'll help you to solve all problems.
6. If the recliner doesn't work, you can try the following measures for self-checking:
  - ① Check if all the cables are connected;
  - ② Check if the pilot lamp of remote control is on or off;
  - ③ Check if the pilot lamp of the power supply is on or off  
(1. on is normal. 2. off, check the wire connection of power supply, if connection is correct but the light is not on, please contact us to change a new power supply for you.)
  - ④ If the motor has a weak buzz on the condition that the two steps above are normal. If the chair still doesn't work, please leave the message to customer service in time. We will help solve the problem for you as soon as possible.
7. If you have any questions about the product, please get in touch with us.

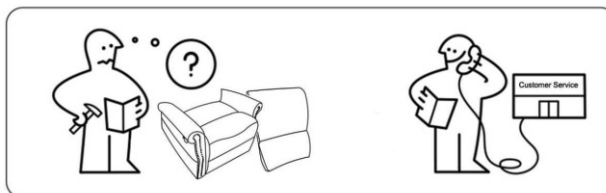
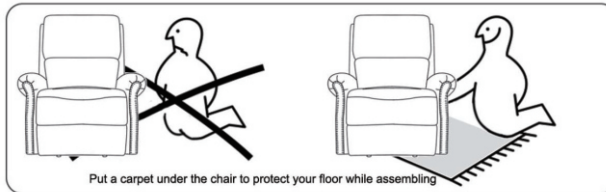
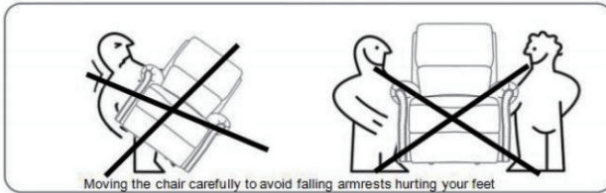

---

## MAINTENANCE INSTRUCTIONS

---

### TO STORE:

Place unit in its box or safety dry and cool place. Avoid putting chair in contact with sharp edges or pointed objects which might cut or puncture the fabric. Do not wrap attached power cord around the unit. DO NOT pull the unit by power cord.

### TO CLEAN:

- Ensure the unit is unplugged from the power source, and allow the unit to cool down before cleaning.
- DO not use any liquid to clean. Clean fabric cover by wiping with a damp sponge, using a mild detergent or suds. Pat with clean, dry cloth.
- Do not use any abrasive cleaners, brushes, gasoline, kerosene, glass furniture polish, paint thinner or water hotter than 120° F to clean the unit.