

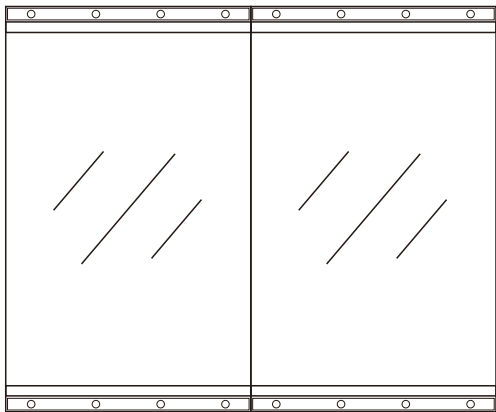

# TRANSFORMATION IN THE MIRROR

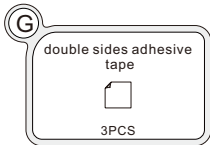

## MATERIAL LIST/MATERIALLISTE

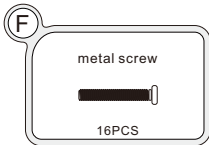
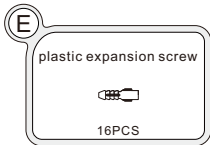
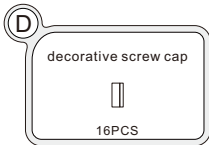
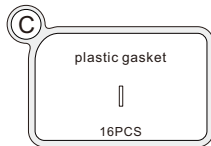
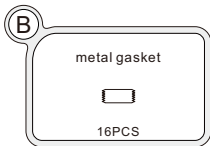
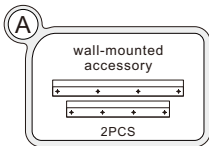

 In order to avoid injury to you and your family, please install carefully.

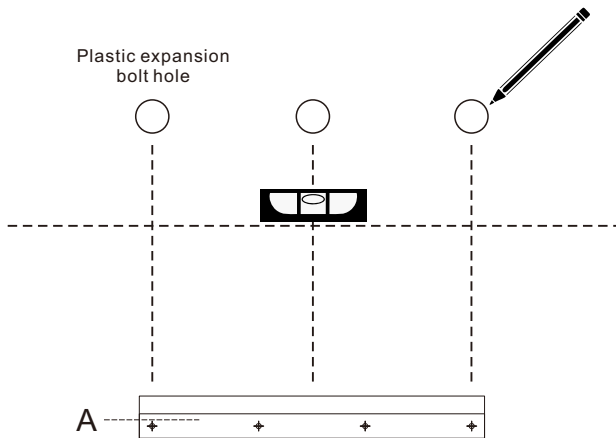
**1****INSTALLATION  
STEPS**

Mark the drilling position of  
the E(plastic expansion screw)  
on the wall with a level

2

## INSTALLATION STEPS

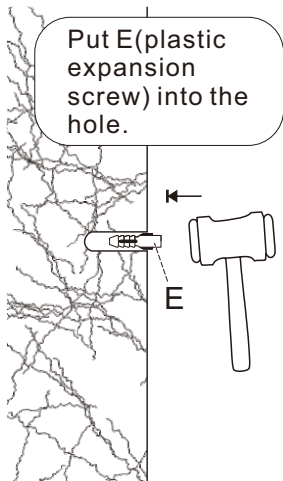
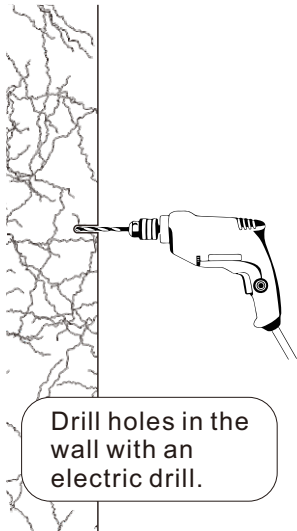

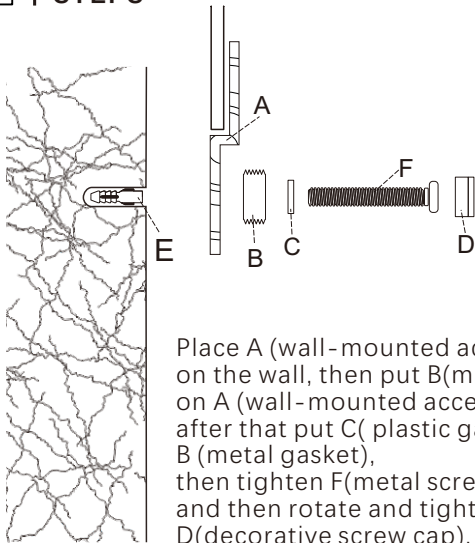
**3****INSTALLATION  
STEPS**

Place A (wall-mounted accessory) on the wall, then put B (metal gasket) on A (wall-mounted accessory), after that put C (plastic gasket) into B (metal gasket), then tighten F (metal screw), and then rotate and tighten D (decorative screw cap).

4

## INSTALLATION STEPS

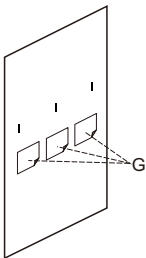

Stick I (double-sided adhesive tape) in the middle of the back of the mirror, then place it on the wall and hold it in A (wall-mounted accessory). Be sure to press down on the mirror to prevent it from falling. At this point, the mirror has not been completely fixed.

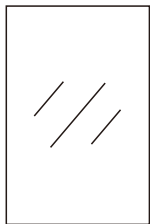

Please place the mirror on the wall mounting accessory from the top.

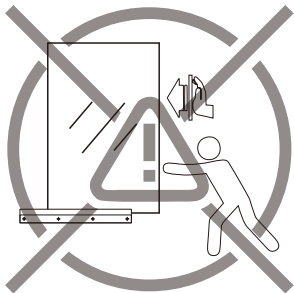
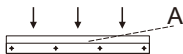

 It is forbidden to push the mirror in from the side.

5

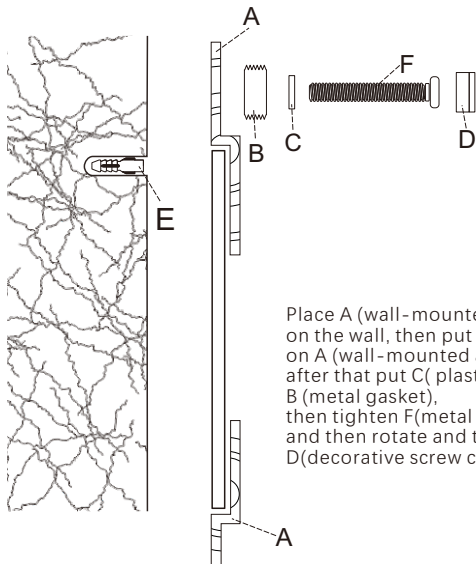
INSTALLATION  
STEPS

Place A (wall-mounted accessory) on the wall, then put B (metal gasket) on A (wall-mounted accessory), after that put C (plastic gasket) into B (metal gasket), then tighten F (metal screw), and then rotate and tighten D (decorative screw cap).

6

## INSTALLATION STEPS

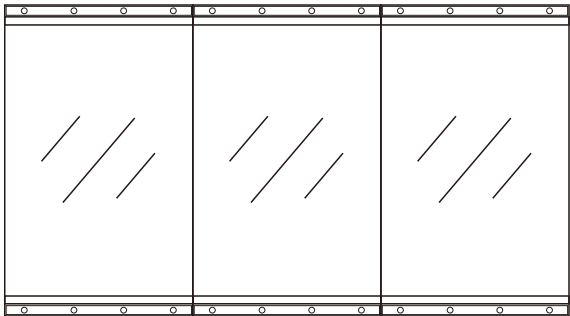

**COMPLETE  
THE INSTALLATION**

