

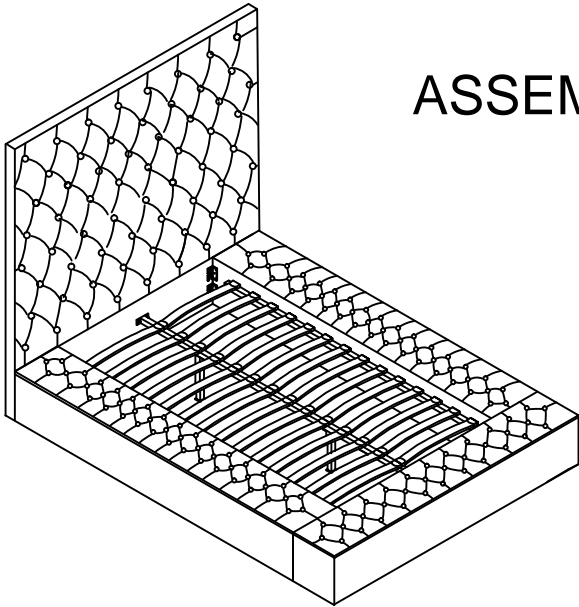

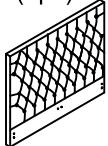

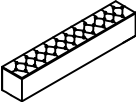

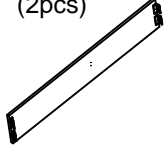
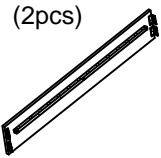

ASSEMBLY INSTRUCTIONS

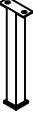
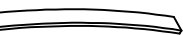
bed - queen

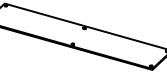
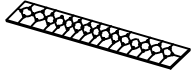

+ Parts Included

- | | | |
|----------------------------------------------------------------------------------------------------------------------|-------------------------------------------------------------------------------------------------------------------------|--------------------------------------------------------------------------------------------------------------------------|
| ① Head Board
(1pc)
 | ② Foot Board
(1pc)
 | 3 Side Rails
(2pcs)
 |
| ④ Side Rails
(2pcs)
 | ⑤ Center Support Bar
(1pc)
 | ⑥ Support Legs
(2pcs)
 |
| ⑦ Slats
(30pcs)
 | ⑧ Single Plastic cap
(30pcs)
 | ⑨ Double Plastic cap
(15pcs)
 |
| *Slats come packed in the bottom of headboard carton. | | |
| ⑩ - Bracket (6pcs)
 | ⑪ - Middle support board (1pc)
 | ⑫ - Middle support board (2pcs)
 |
| *Middle support Board comes packed in the footboard carton 2/3 | | |
| *Middle support Board comes packed in the footboard carton 2/3 | | |
| ⑬ - Side bottom board (2pcs)
 | * 1of2 side bottom boards comes packed in side rail carton 3/3. 2/2 packed in footboard carton 2/3 | ⑭ - Side top board (2pcs)
 |

+ Do Not Use Power Tools

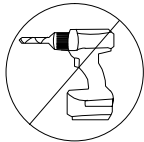

+ Suggested Adults

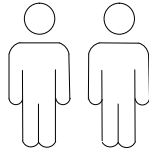

NOTE:

- 1 Read instructions cover to cover.
- 2 Save all packaging until assembly is completed.

1 IMPORTANT SAFETY INFORMATION

Do not assemble the product if any of the following parts arrived damaged:









- Part #③ -Side Rails
- Part #⑤ -Center Support Bar
- Part #⑥ -Support Legs
- Part #⑦ -Slats

2 IMPORTANT ASSEMBLY INFORMATION

Assembly Step ③ Ensure the side rail bracket is fully hooked onto bolt A loosely threaded with both washers on the OUTSIDE of the bracket first, then proceed to fully tightening all 4 corners.

Assembly Step ⑥ When installing slats, ensure that the curve is facing upwards. (✓) (✗)
*Slats come packed in the bottom of headboard carton.

+ Hardware Included

- | | |
|---------------------------------------------------------------------------------------------------------------------|---------------------------------------------------------------------------------------------------------------------|
| A Bolt M8*30mm
(36pcs)
 | B Bolt M8*20mm 26pcs
 |
| C Nut M8*13mm
(4pcs)
 | D Spring Washer
(32pcs)
 |
| E Flat Washer
φ20(66pcs)
 | F M8 Allen Key
(1pc)
 |
| G Spanner
(1pc)
 | H Bolt M8*25mm
(4pcs)
 |

ASSEMBLY INSTRUCTIONS

bed - queen

