

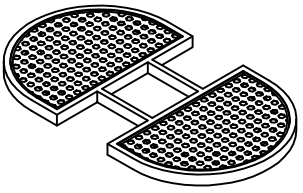
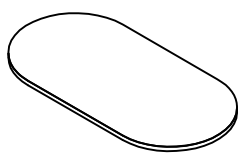
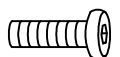
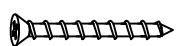

Parts and Operation Elements

					
①	1PC	②	1PC		

Hardware

 M6*22mm		 φ4*40		 φ8*40mm			
Ⓐ	4PCS	Ⓑ	4PCS	Ⓒ	4PCS	Ⓓ	1PC

1

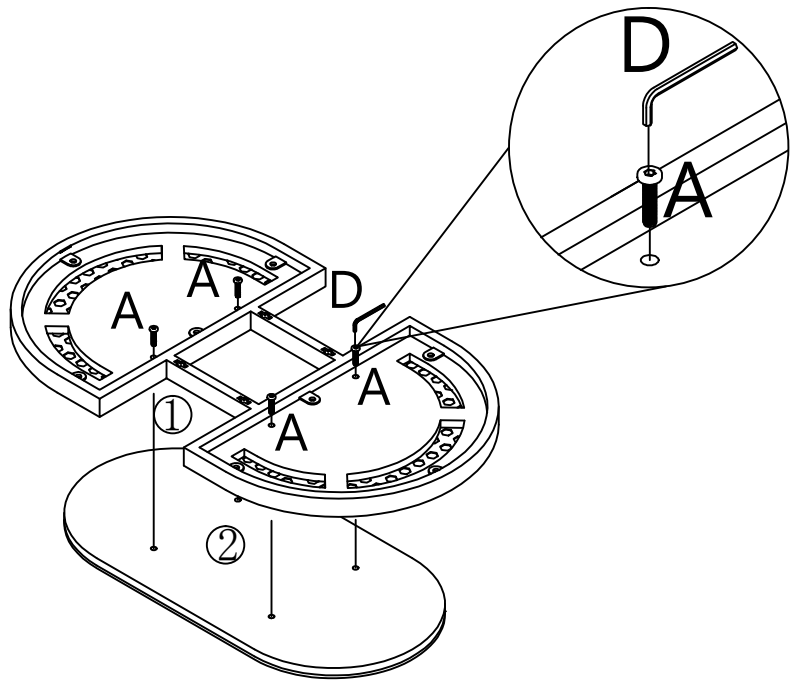

2

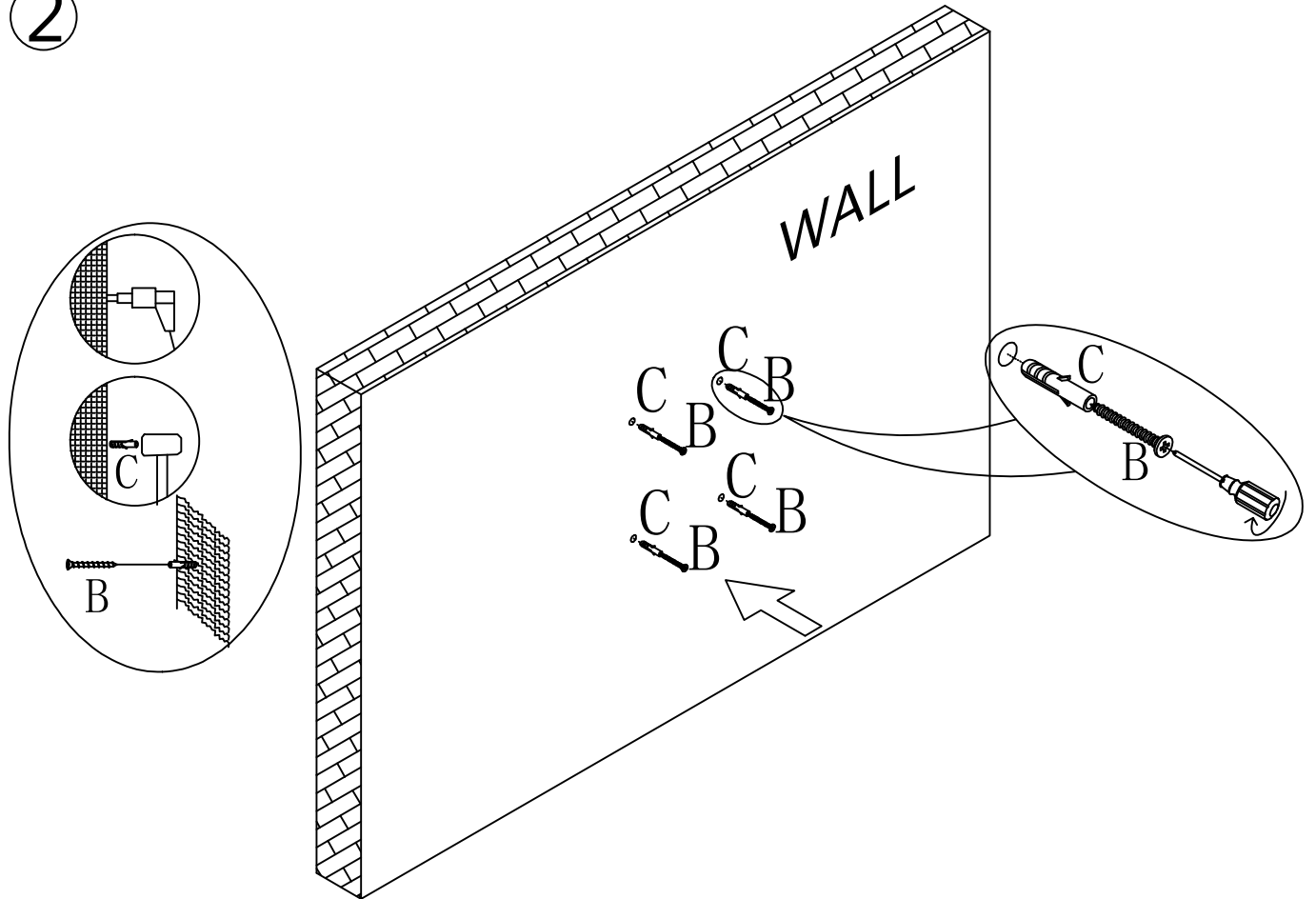

3

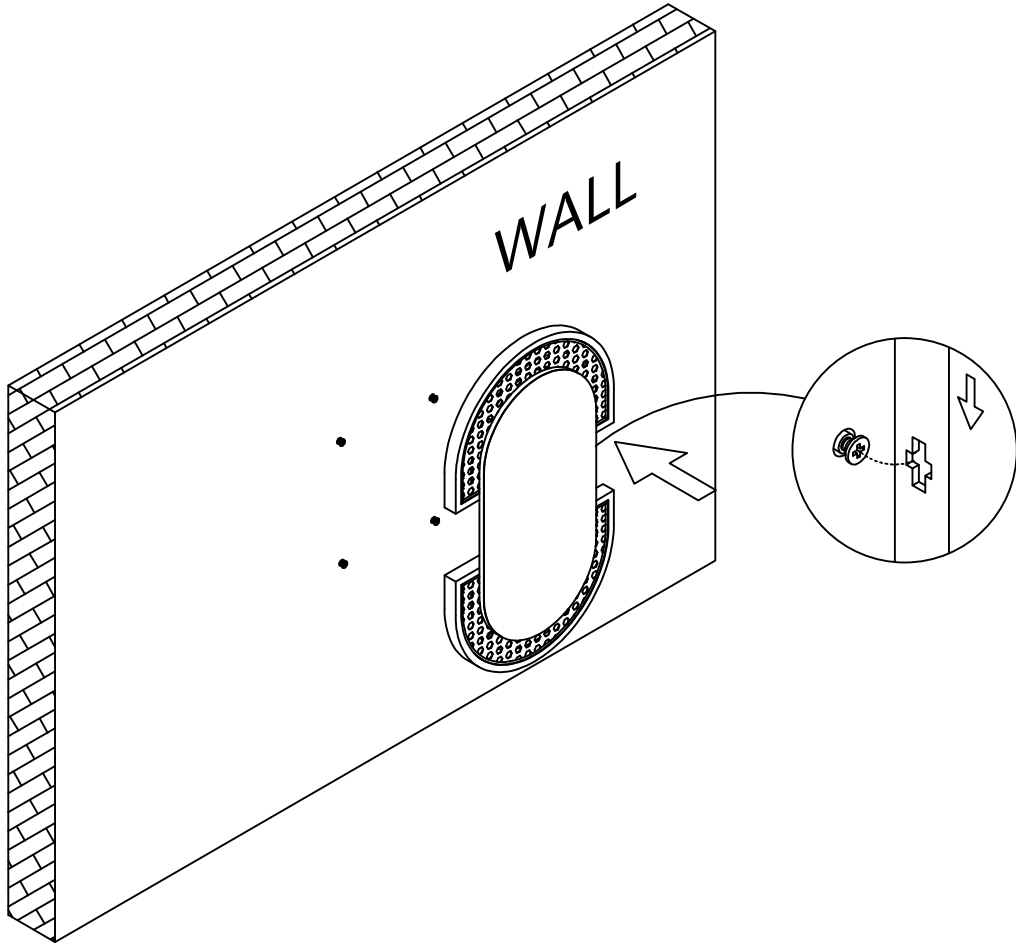

4

