

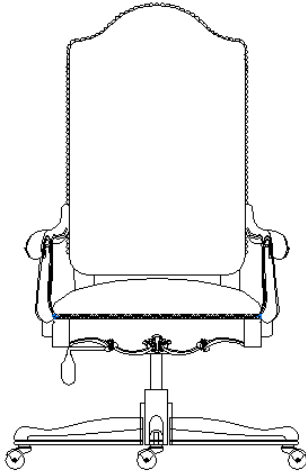

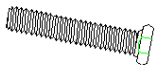

ASSEMBLY INSTRUCTION

Item#: 5070-30220 TILT SWIVEL CHAIR

*** Please ensure you have all parts indicated below prior to assembly.



NO	Hardware List	Q'ty
D	 5/16" BOLT	4
E	 LOCK WASHER	4
F	 FLAT WASHER	4
C	 ALLEN WRENCH	1

This item should be assembled on a flat, soft surface to prevent from scratching the finish while assembling.

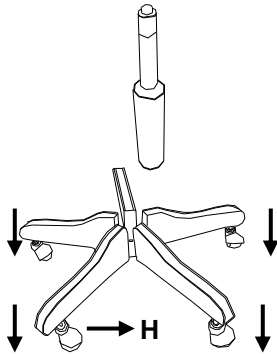

1. Insert the Pneumatic Cylinder into the base, this is a taper fit no mechanical fastening is necessary.

Note: Casters (H) are removable.

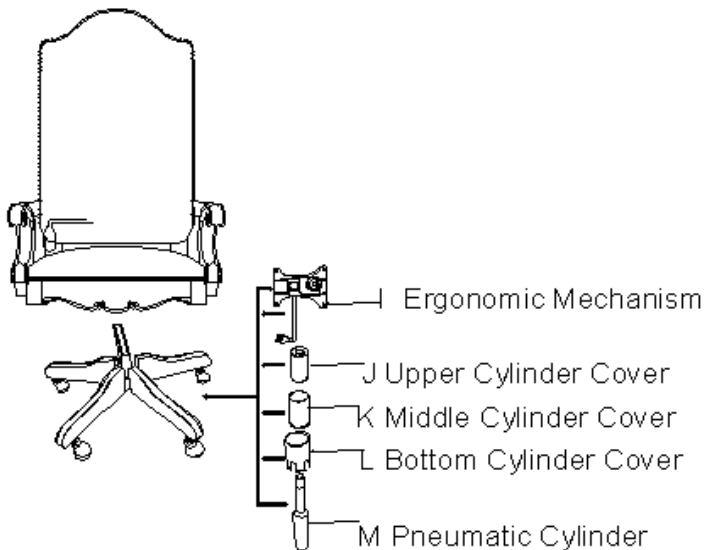

2. Place Cylinder cover over the cylinder

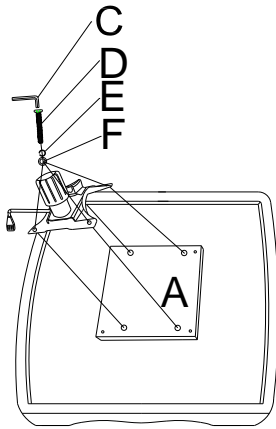

- Use the Allen Wrench (C) with 4 bolts (D), 4 lock washers (E), 4 Flat Washers (F), attach the ergonomic mechanism to the bottom of the seat.

Please note the correct direction to place the tilting mechanism, follow the left diagram.

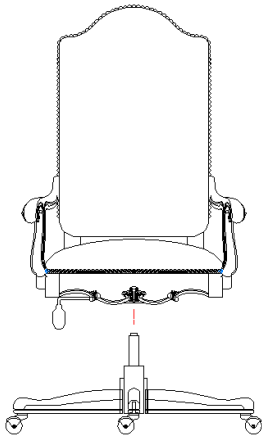

- Place the chair body onto the Cylinder. No mechanical fastening is necessary because this is a taper fit. Now sit in the chair. This will firmly secure the taper fit.

You can lower, raise and tilting the seat rightly:

The seat can be adjusted so that your feet are comfortably flat on the floor.

To lower the seat:

While seated, raised the seat height lever, the chair will lower with your body weight. The seat height lever will lock into place when you release the lever.

To raise the seat:

Move your weight slightly from the chair and raise the seat height lever, the chair will raise when the lever is lifted. The seat height lever will lock into place when you release the lever.

Tilting the seat:

To tilt the chair back, pull out the seat height lever.

To lock the chair to prevent tilting, push the seat height lever in.

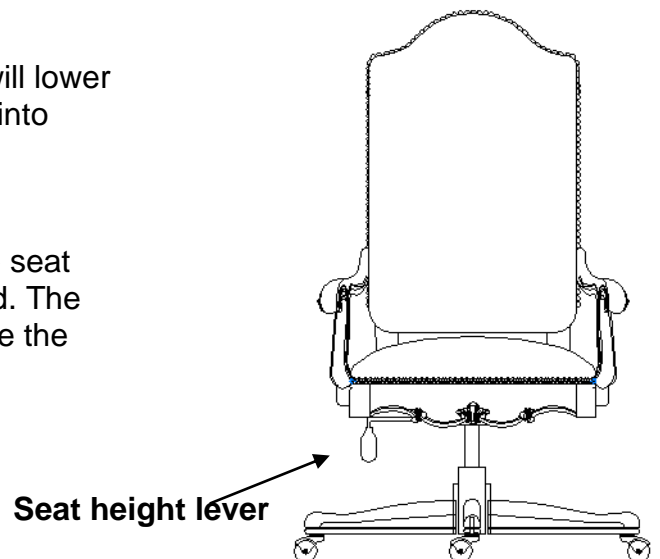

Cleaning Instruction: Clean finished parts with a mild dishwashing liquid and water solution on a damp cloth. Polish the finish with soft cloth and an industry recognized furniture polish