

ADJUSTABLE BASE USER MANUAL

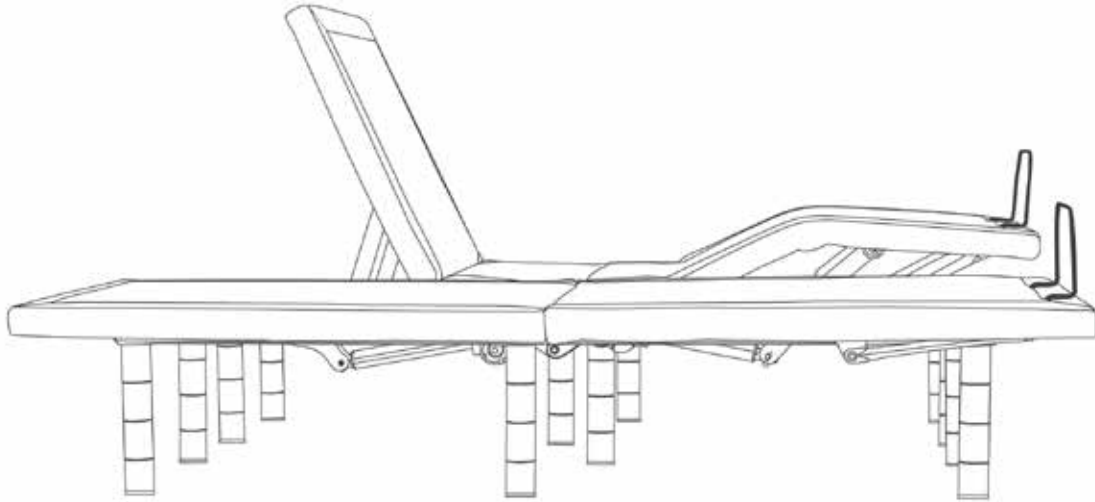

MODEL: SBKDP

SERIAL NUMBER:

Please read and keep for future reference.
This manual contains important safety information.

TABLE OF CONTENTS

IMPORTANT SAFETY INFORMATION	4	REMOTE CONTROL SYNCHRONIZING TWO ADJUSTABLE BASES	14
WEIGHT RESTRICTIONS AND EMERGENCY BACKUP	5	REMOTE CONTROL FEATURES	15
FEATURES	6	FAQ	16
GETTING STARTED	7	TROUBLESHOOTING GUIDE	17
POWER CORD SETUP	8	COMPONENT GUIDE	18
JOINING TWO ADJUSTABLE BASES (CONNECTING STRAP)	9	10 YEAR LIMITED WARRANTY	19
LEG ASSEMBLY	10		
MATTRESS RETAINER BAR ASSEMBLY	11		
KD2 HEADBOARD FOOTBOARD BRACKET INSTALLATION	12		
REMOTE ASSEMBLY AND FREQUENCY SET UP	13		

IMPORTANT SAFETY INFORMATION

PLEASE READ ALL INSTRUCTIONS AND SAFETY INFORMATION CAREFULLY BEFORE USE AND ASSEMBLY

SAFETY INFORMATION

Only use the adjustable bed base for its intended use as described in this manual. Follow the guidelines below for your safety, the safety of others and to avoid risk of electrical shock, fire, burns or injury:

- Avoid fingers in pinch-points.
- Two or more adults is strongly recommended for moving and assembling of the adjustable bed base.
- Plug adjustable bed base into a surge protector (not included) or directly into a suitable wall outlet.
- If the plug does not fit your outlet, contact a qualified electrician to install a suitable outlet. Unauthorized modification or failure to use a proper power source or surge protector will void the electrical portion of your warranty.
- Keep power cords away from heated surfaces.
- To safely disconnect, ensure the base is in a flat position with all motors off, and unplug from power source.
- Always unplug the base from the electrical outlet before cleaning or servicing.
- Discontinue use of the bed base and contact a qualified service center if: it has a damaged cord or plug, is not working properly, or has been dropped into water.
- Do not place the adjustable bed base or any of its components near or in water.
- Do not drop or insert objects into any opening. Never operate the base when there is an obstruction between the moving parts of the adjustable base and the metal frame.
- Replacing parts on the adjustable base is allowed to be done by consumer, however tampering with internal components will void the warranty.
- Do not use accessories/attachments that are not recommended by the manufacturer.
- Exceeding this weight restriction could damage the bed and/or cause injury and will void the warranty.

- Do not operate the adjustable bed base when a person or animal is underneath the adjustable bed base.
- Mattresses may move or shift on bases – use caution.
- All 6 legs must be installed and resting evenly on the floor. The legs must be a minimum of 6" to maintain articulating clearance and must not exceed 12"; anything taller is considered unstable.

VIOLETING ANY OF THE SAFETY INFORMATION WILL VOID THE WARRANTY AND MAY RESULT IN INJURY OR DAMAGE TO FLOOR

TIPPING WARNING

Placing weight at the edge may cause base to tip.

IN-HOME USE

The adjustable base is designed solely for in-home use. This base was not designed as a hospital bed and is not designed to meet hospital standards. Do not use this base with tent type oxygen therapy equipment or near explosive gases.

OPERATION AND SUPERVISION

Close supervision is required when the bed base is used by or near children, animals, convalescents or disabled persons. Immediately dispose of all packing materials as they may pose a risk to small children and pets. To avoid injury, do not allow children or small pets to play on or under the adjustable bed base.

PACEMAKERS

As with any product that produces a vibrating motion, it is possible that some pacemakers may interpret this motion as a false sense of movement and/or exercise. This may or may not affect your pacemaker. If you have any concerns, please consult your physician.

WEIGHT RESTRICTIONS

The recommended weight restriction for the adjustable base is 750 pounds, which is calculated to include the weight of the mattress. To calculate the weight limit, subtract the weight of the mattress from 750 pounds. The bed will support the recommended weight limits if distributed evenly across the base. This product is not designed to support or lift the total maximum weight limit by the head or the foot section only. Consumers should not enter or exit the bed with any portion of the adjustable base in the raised position; always return the bed to a flat position prior. If the weight limit is exceeded on the head or foot mechanism, the master controller will stop all functions. Exceeding the recommended weight limit restrictions could damage the bed and void the warranty.

EMERGENCY BACKUP

In case of a power failure, the adjustable base features an emergency backup that allows you to return the bed to the flat position without power.

- Step 1:** Unplug the adjustable base.
- Step 2:** Locate the Emergency Battery Backup Box that is attached to the power cord.
- Step 3:** Insert four 9-volt alkaline batteries (not included) into the battery box.
- Step 4:** Press and hold the reset button on the body of the control box to flatten the bed. (Reset button is inset. This step can only be completed with a pen-tip or an object with a similar shape).
- Step 5:** Immediately remove the four 9-volt batteries after the base is returned to the flat position. The four 9-volt batteries must be removed before power is restored to the adjustable bed base.

Warning: Leaving in the 9-volt batteries in the Emergency Battery Backup Box after power has been restored will cause the electrical components to short out and damage the master controller.

FEATURES

- Head and foot up/down positions
- Head and foot massage at 3 intensities with 10 minute auto shut-off
- USB charging ports
- 14 button wireless remote control
- Under bed lighting
- Pre-programmed positions: anti-snore, zero gravity, and flat position
Programmable positions: I, II and III
- Six legs with customizable heights
- Undercarriage is made with reinforced steel components for strength and durability Emergency backup battery box
- Mattress foot retainer bar

CONTACT OUR COMFORT CONCIERGE TO PURCHASE ACCESSORIES

- Head and footboard brackets

Note: This base is designed to fit within a standard bedframe.

OPERATING NOISES

The massage function emits a noticeable tone during operation. As the massage intensity level is increased, the tone will intensify. The noise will be less audible on a carpeted floor and a bit more noticeable when on a hard floor surface.

During typical operation, the wheels, which allow the bed to articulate, will make contact with the steel platform supports of the base creating a contact noise. When entering, exiting or shifting weight on the base, this contact noise may be audible as the wheels make contact with the steel platform supports of the base. This is normal. Depending on the incline of the base, the noise levels can also potentially increase.

GETTING STARTED

NO TOOLS REQUIRED FOR ASSEMBLY.

Use caution at pinch points and unfolding the base as parts may have shifted during shipping.



(1x) Wireless Back-Lit Remote
(3x) AAA Batteries
Included per Base



(6x) Four-Piece Adjustable Legs

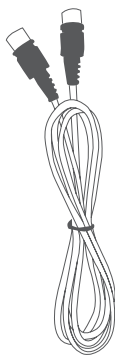

(1x) Simultaneous Synchronization Cable
(Only included with Twin XL/CKS bases)



(1x) Split Adj Base Sets Connecting Strap
(Only included with Twin XL/CKS bases)

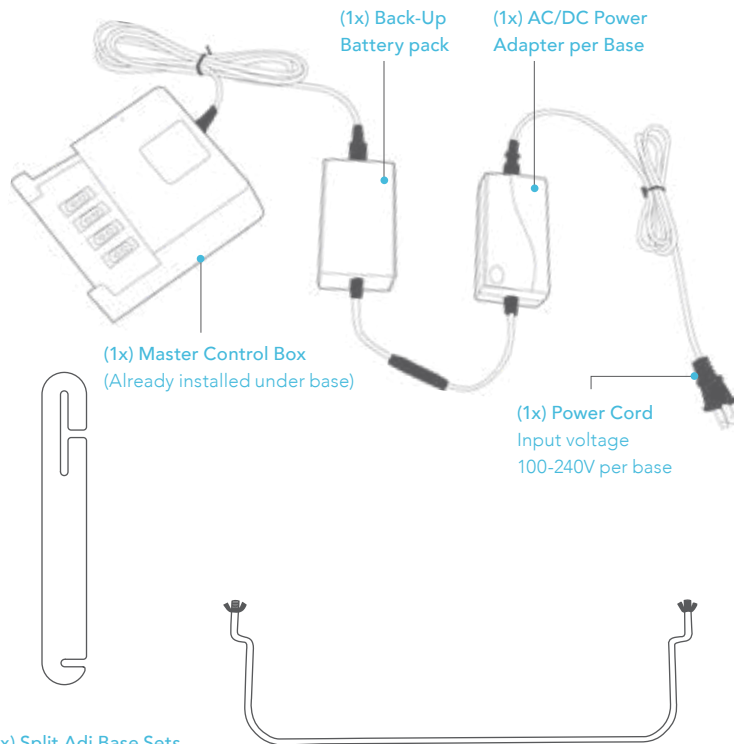

(1x) Master Control Box
(Already installed under base)

(1x) Back-Up Battery pack

(1x) AC/DC Power Adapter per Base

(1x) Power Cord
Input voltage
100-240V per base



(1x) Foot Retainer bar
(2x) Wing-nuts per Base

POWER CORD SETUP

CAREFULLY open the adjustable bed base into an L position on its side or lay flat with the bottom facing up. This step may require two adults for safety.

Ensure all power cord connections circled to the right are completely plugged-in.

Installation of the Backup Battery Pack is optional. Only put batteries into the Backup Battery Pack during an electrical outage and after the power cord is unplugged from a power source.

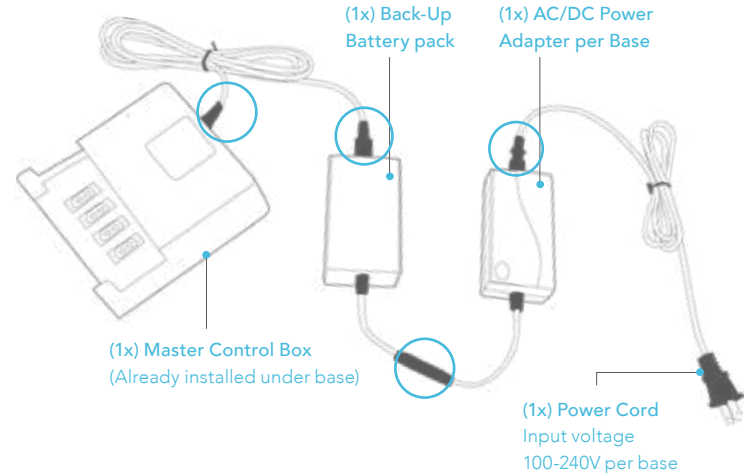

JOINING TWO ADJUSTABLE BASES

If any split setup is being installed, plastic connecting straps are provided (one per base) to secure the bases together. Use both straps to secure the head and foot portions together.

With the bases in their desired location, slightly loosen both legs to allow the strap to fit on the leg bolt, between the leg washer and frame.

Slide side (A) of the connecting strap onto leg bolt. Swing the strap and connect side (B) to the leg bolt. Secure the strap by shifting to the left.

Re-tighten legs. Do not over tighten. Use the remaining strap and repeat on other end of the base.

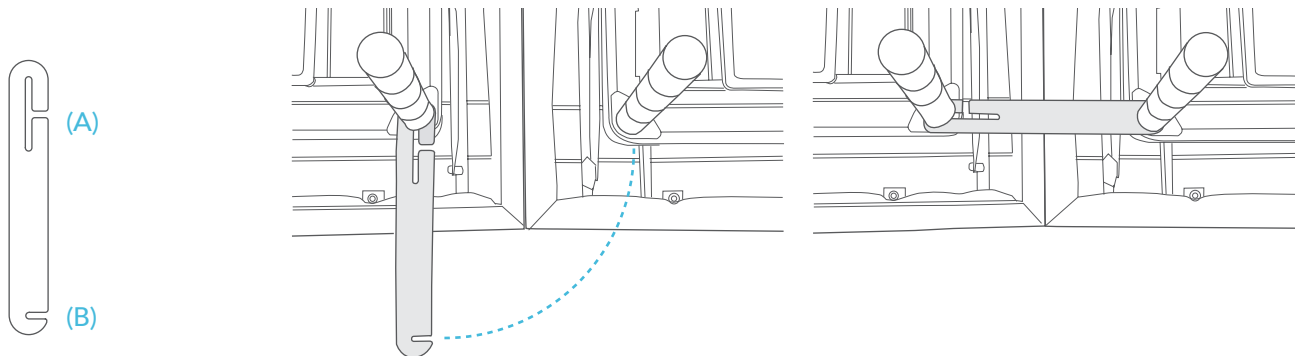

LEG ASSEMBLY

Locate the legs and choose one of the heights.

Make sure the leg with the solid end is touching the floor. Screw six legs into the pre-drilled holes by hand. All legs must be installed and resting evenly on the floor. The base will not operate properly without the legs.

The legs must be a minimum of 6" to maintain articulating clearance and must not exceed 12"; anything taller is considered unstable.

VIOLATING ANY OF THE SAFETY GUIDELINES MAY RESULT IN DAMAGE OR INJURY, VOID THE WARRANTY FOR IMPROPER USE AND MAY CAUSE DAMAGE TO THE FLOOR.

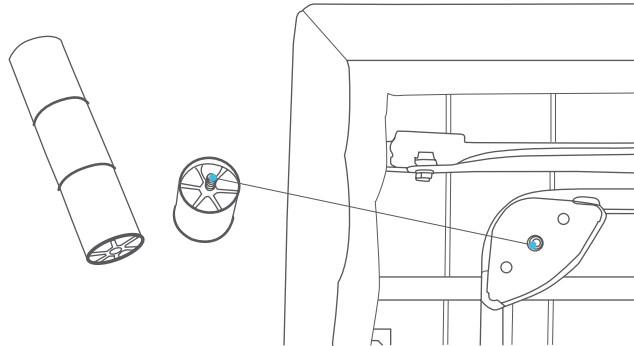

MATTRESS RETAINER BAR ASSEMBLY

Locate the mattress retainer bar in the packaging.

At the foot of the base, there are two openings to insert the mattress retainer bar. Slide the large retainer bar into the opening at the foot of the bed.

Secure the retainer bar (Figure 1) with the included wing-nuts (Figure 2). This will hold the mattress retainer bar in place.

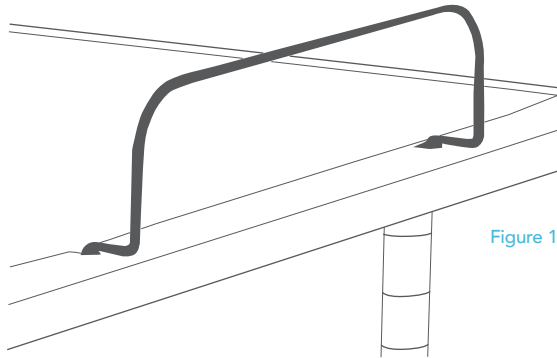

Figure 1

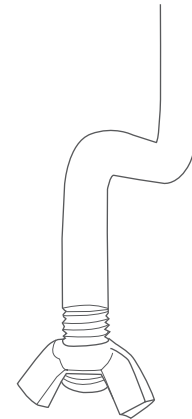

Figure 2

KD2 HEADBOARD & FOOTBOARD BRACKET

*Optional Accessory

Recommended Tools

- Socket Wrench
- Crescent Wrench

Included



(8x) Nut



(8x) Washer

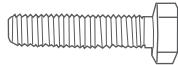

(8x) Long Bolt

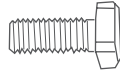

(8x) Short Bolt

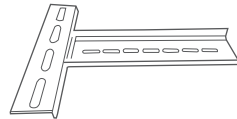

(4x) T-Connector

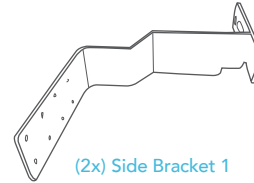

(2x) Side Bracket 1

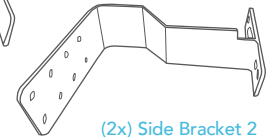

(2x) Side Bracket 2

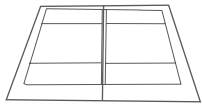

Figure 1A

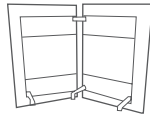

Figure 1B

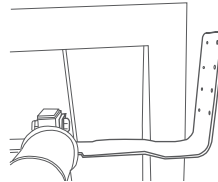
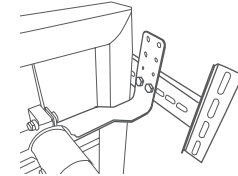

Figure 2A



- 1 Carefully place the base flat (Figure 1A) or in a side L position (Figure 1B).

- 2 **Hardware: (2x) Long Bolts, (2x) Nuts, (2x) Washers, (1x) Side bracket**
Locate the two holes on the frame at the corner of the adjustable base, by the leg. Find the side bracket with the correct angle (see Figure 2A). Align bracket with base holes and attach using (2x) Long Bolts, (2x) Nuts and (2x) Washers. Repeat this step for all sides.

- 3 **Hardware: (2x) Short Bolts, (2x) Nuts, (2x) Washers, (2x) T-connector's**
Carefully place the base near its desired location. Attach each T-Connector with (2x) Short Bolts, (2x) Nuts and (2x) Washers. Find the correct height and width for the headboards/footboards and attach using the extra bolts or the bolts provided with your existing furniture. Check that all brackets and furniture are secured prior to use.

REMOTE ASSEMBLY AND FREQUENCY SET UP

Locate the wireless remote control and insert (3x) AAA batteries (included). The remote control is pre-programmed to work with the adjustable bed base. If you have more than one adjustable bed base, each remote control and adjustable bed base set should be pre-programmed to work separately.

If the remote control is not communicating with the bed (the base is not responding by moving when the remote control is activated), please follow the below steps:

- Step 1:** Unplug the adjustable base that is not being programmed.
- Step 2:** While the bed that is being programmed is plugged in, remove the battery cover on the back of the remote control.
- Step 3:** Double click the switch on the control box under the base. At this time, the light will illuminate.
- Step 4:** Press and hold the button on the back of the remote. The light will begin to flash.
- Step 5:** Both lights on the control box and remote will be continuous, then simultaneously turn off. At this point, pairing is complete.

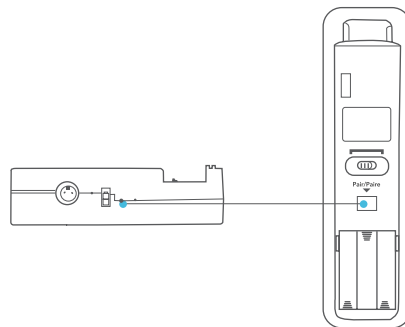

FCC Compliance

This device complies with part 15 of the FCC Rules. Operation is subject to the following two conditions: (1) This device may not cause harmful interference and (2) this device must accept any interference received, including interference that may cause undesired operation.

To comply with the FCC RF exposure compliance requirements, no change to the antenna or the device is permitted. Any change to the antenna or the device could result in the device exceeding the RF exposure requirements and void user's authority to operate the device.

Radio Frequency: 2.4 GHz

REMOTE CONTROL SYNCHRONIZING TWO ADJUSTABLE BASES

Step 1: Unplug base from power source.

Step 2: Connect the end of the simultaneous synchronization cable into the splitter for each control box. Use any open slot on the splitter. Do not disconnect any other cords connected to the splitter; this will cause other features on the base to malfunction. Only one sync cord is needed.

Step 3: Plug base back into the power source.

Step 4: Check to ensure all cords are securely attached. Both remotes will now operate both bases simultaneously.

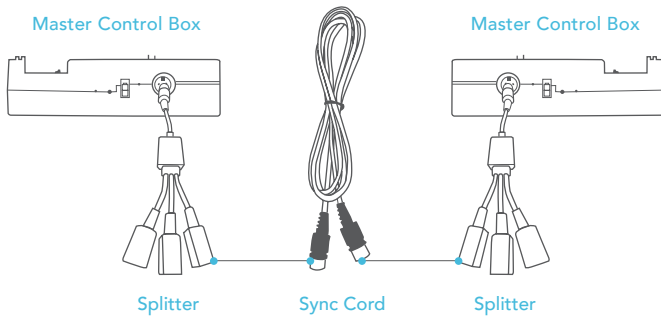

Dual Side Control Feature

Control the other side of the bed or both sides with the flip of a switch. Steps 1-4 must be completed prior to enable this feature. Move slider switch on back of remote to set which base it will control. For bed A (slide to far left), bed B (slide to far right) or to control both beds A and B simultaneously (slide switch to the middle).

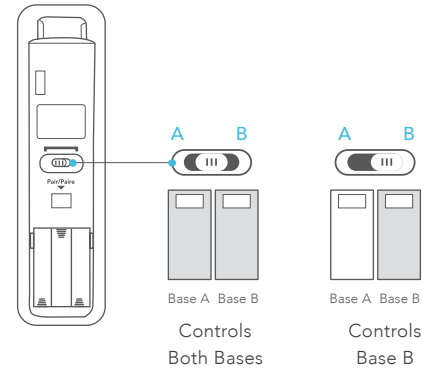

REMOTE CONTROL FEATURES

Programming button I, II or III: Get into desired adjustable base position, hold button for 5 seconds.

BUTTON CYCLES

1x low / 2x mid / 3x high / 4x off

Anti-Snore returns to the flat position after five minutes.

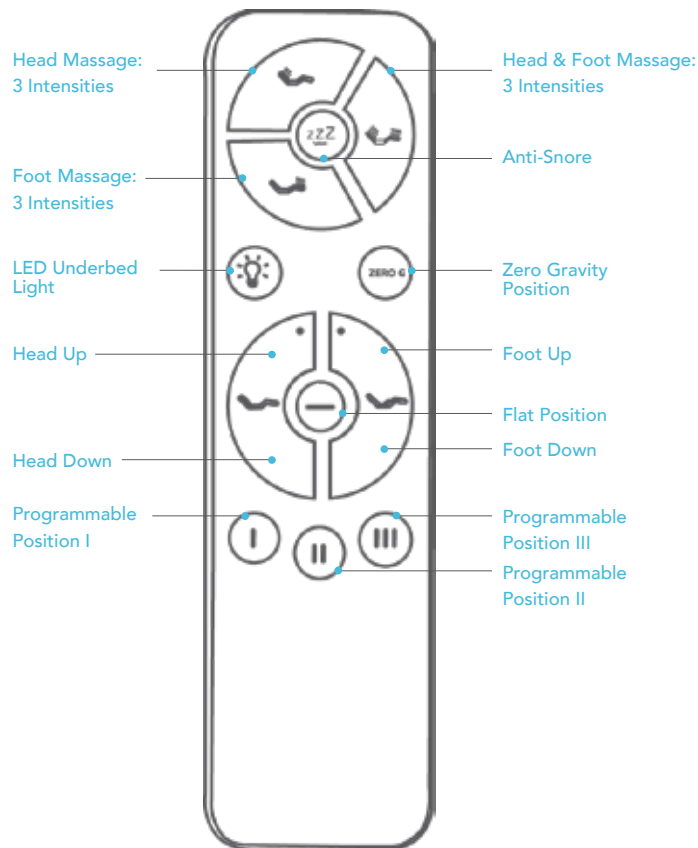

FAQ

Will the adjustable base fit inside my current bed frame?

Yes, we designed the adjustable base width and length to be ½" shorter than standard bed sizes to ensure the base fits within most* bed frames. Even if you have a headboard and footboard with side rails and slats, our adjustable base will fit right in place.

*Some bed frames, such as sleigh bed frames, do not provide enough clearance for the mattress when the adjustable base is articulated.

Adjustable base dimensions

Twin XL: 37.5"W x 79.5"L x 15"H

Full: 53.5"W x 73.5"L x 15"H

Queen: 59.5"W x 79.5"L x 15"H

Split King: (x2) 37.5"W x 79.5"L x 15"H

Cal King Split: (x2) 35.5"W x 83.5"L x 15"H

What size of sheets do I buy for a King Split or Cal King Split adjustable base?

Eastern Split King (EKS): Eastern King Split sheet set OR (2) Twin XL sheets

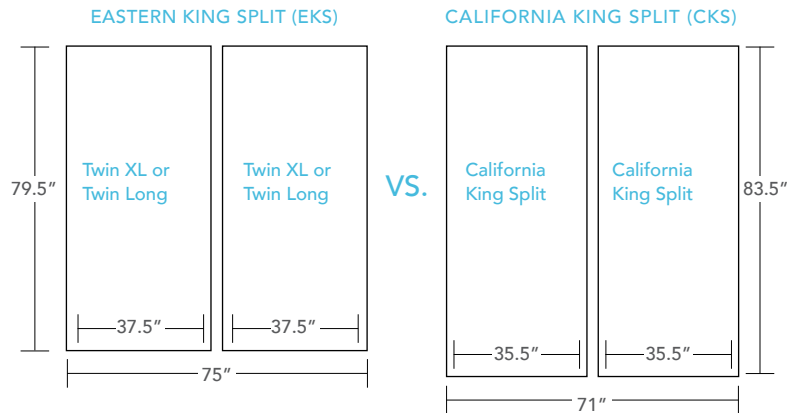

Also known as "Split King," each half of the EKS is a Twin XL/Twin Long size.

Overall sleeping surface area is the same in the EKS and CKS.

The EKS is wider by 4" and the CKS is longer by 4".

TROUBLESHOOTING GUIDE

If one or more functions on the base have stopped operating:

- Check under the bed base to verify that the wired connections are secure and that there are no cords or bedding obstructing the movement of the base.
- Check that the power cord is assembled properly and that the connections are secure.
- Check if green LED is on (power supply).

If the lights on your remote control no longer illuminate and will not operate your adjustable bed base:

- Make sure the batteries are installed correctly.
- Install (3x) new AAA batteries in the remote control.

If all of the remote control buttons illuminate, however nothing on your adjustable bed base will operate:

- Unplug the base for 5 minutes to reset the electronic components.
- Plug the adjustable base into a different electrical outlet, or test current outlet with another working appliance (a grounded, electrical surge protector is recommended).
- Complete the "Remote Assembly and Frequency Set Up" as the frequency on the bed may have been lost.

If the head or foot mechanisms will elevate but will not return to the flat position:

- Check the undercarriage for obstructions. Remove any obstructions away from the head and foot mechanisms and return the base to its flat position.

If you have any questions regarding this product or if you need assistance with set up or troubleshooting, please call our Comfort Concierge at 1-877-622-6550.

COMPONENT GUIDE



10 YEAR LIMITED WARRANTY

FULL 1-YEAR WARRANTY The Adjustable Base is warranted against defects in materials or workmanship for a period of one year from the date of purchase to the original purchaser. During the first year, manufacturer will repair or replace, at no cost to the original purchaser, any defective part. This includes all authorized labor and transportation costs incurred with the repair or replacement of any parts found to be defective.

2 YEAR MOTOR WARRANTY The Adjustable Base has a two year, full replacement warranty, parts, labor and transportation; on the motor should the motor(s) fail during the first two years of this warranty from the original purchase date.

5 YEAR WARRANTY During year 2 through year 5, from the original purchase date, manufacturer will replace any bed part, to the original purchaser, found to be defective. The part must be returned within fourteen (14) days of receipt of the replacement part(s) or purchaser may be subject to charges for said part(s) to include, but not limited to freight charges. Liability of manufacturer is limited to the replacement of the defective part or parts ONLY with purchaser responsible for all service, installation and transportation costs of said part(s).

10 YEAR LIMITED WARRANTY During year 6 through year 10 from the original purchase date, manufacturer will replace, per the terms and conditions set forth in this paragraph, any bed part found to be defective. Purchaser shall pay 1/180 of the current replacement cost of the defective part multiplied by the number of months, after the fifth (5th) year, from the original purchase date. This warranty applies only to replacement part(s). Purchaser may be subject to charges for said part(s) to include, but not limited to, freight charges. Liability of manufacturer shall be limited to the replacement of the defective part(s) only with purchaser responsible for all service, installation and freight costs of said part(s).

ADDITIONAL TERMS AND CONDITIONS Warranty does not include reimbursement for inconvenience, removal, installation, set up, loss of use, shipping, or any other costs or expenses not expressly covered in this warranty.

This warranty does not apply:

- To damage resulting from misuse or abuse caused by the purchaser.
- To damage caused by the repairs or parts replacement by an authorized person.
- If the Adjustable Base has been mishandled (including during shipping), subject to physical abuse or an improper power supply, or otherwise operated in a manner inconsistent with procedures outlined in the owner manual and warranty.
- To damage to mattresses, bedding, cables, electrical cords, or accessories supplied by dealers.
- To modification of the Adjustable Base without prior written consent by manufacturer.
- To costs for unauthorized service calls for the purpose of educating the consumer about the Adjustable Base or locating properly functioning power outlets.
- If the recommended weight restrictions are exceeded.
- If used in any environment or a commercial setting for which it was not intended. Some states do not allow the exclusion of incidental or consequential damages; therefore the above limitation or exclusion may not apply. This warranty gives the purchaser specific legal rights. The Purchaser may have the other rights, which may vary from state to state. This warranty is valid in the 48 continuous states.

WORKING WEIGHT LIMITS Although your Adjustable Base has been rigorously tested within the recommended limits in this publication, to maintain the highest quality standards, exceeding the recommended weight limits may void your warranty. The recommended weight restriction is 750lbs, and is calculated to include the weight of the mattress.