

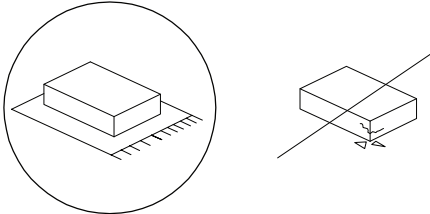

		10'
		
		1

A



B

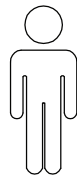
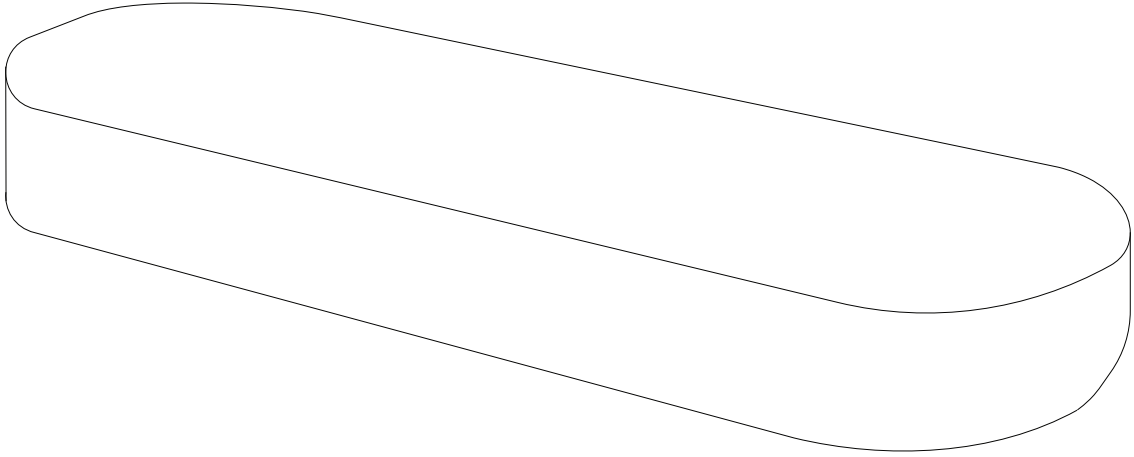
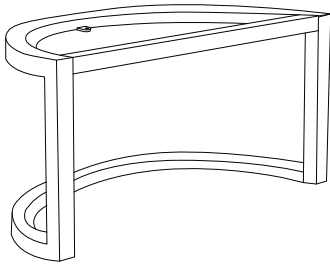

B

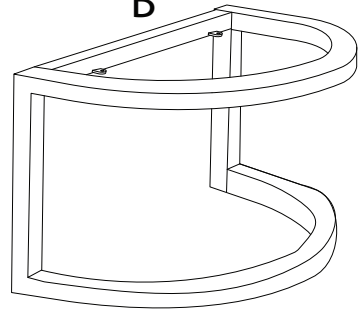

A

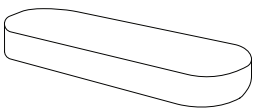

x 1

B

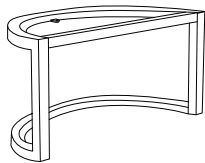

x 2

C



M6
x
16

x 6

D

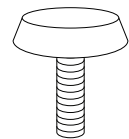

x 6

1

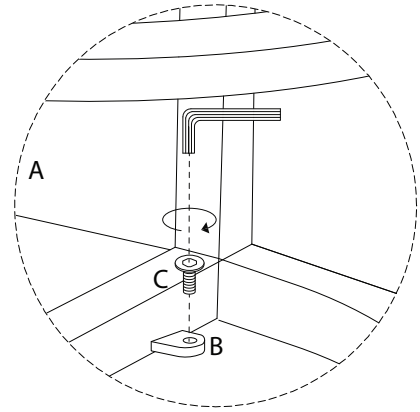
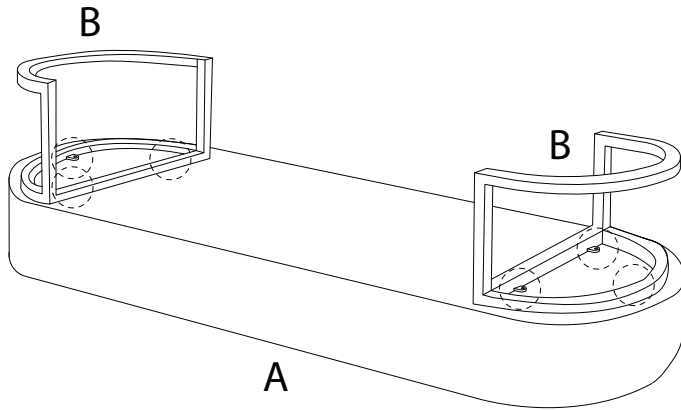
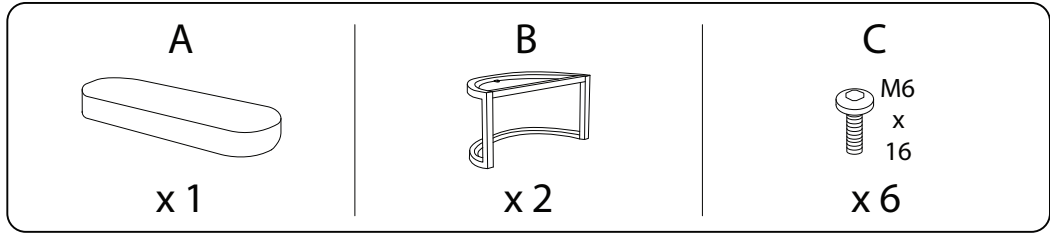

2

