

ASSEMBLY INSTRUCTIONS



TOOLS REQUIRED



Screwdriver
(Not included)

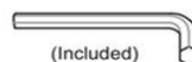

(Included)
Allen Wrench



2 - People

ASSEMBLY RATING



EASY —————> DIFFICULT

The Assembly Rating is a 5-point system showing the level of effort needed to assemble a specific product.

VERSION# 24-05-20



CHECK BEFORE STARTING

Are you missing anything?
Double-check all parts, hardware and accessories listed are all accounted for.

Should we send any replacements?
Are there any irregularities or flaws in the parts? We can send replacements!

Check out our Quick Tips!
We recommend reviewing the pre-assembly handouts. Even experts need a refresher now and then!

Prep Time!
Please review the assembly instructions and all diagrams prior to assembling.

PRE ASSEMBLY INTRODUCTION

We understand building ready-to-assemble furniture can be a challenging experience for some. To help avoid confusion, we have provided some helpful tips that may speed up the process.



Teamwork

ALWAYS have at least two people to help with transporting and assembling the product to avoid potential injury and/or damage.



Suitable Location

Assembling near the area of the intended location is highly recommended.



Sufficient Space

Make sure you have enough space to move around during the assembly.



Avoid Scratches

Use cardboard, blankets or a carpeted area while assembling furniture to prevent to prevent scratches and damages.



Flat Surface

Make sure the furniture rests on a flat and level surface with each leg evenly touching the floor.

ASSEMBLY AND CARE ADVICE



FAILURE TO FOLLOW THE GUIDELINES BELOW MAY RESULT IN INJURY AND/OR PROPERTY DAMAGE.



Position each part correctly and insert screws or bolts into their respective holes.

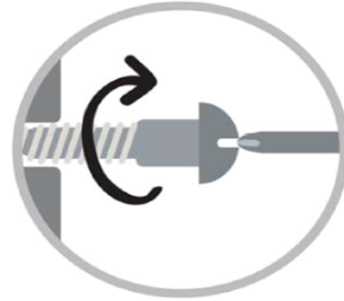

Turn clockwise to tighten and only tighten when step is completed or when instructed to do so.



Use the appropriate hand tools or power tools for assembly. Select steps, such as tightening screws and/or bolts, may require hand tools to avoid causing damage during assembly.



Save the instructions and store any supplied tools for later maintenance.



After two weeks, check and tighten any loose hardware and repeat again every six months thereafter.

IT IS THE USER'S RESPONSIBILITY TO MAINTAIN THE FURNITURE. THE HARDWARE MAY LOOSEN OVER TIME AND MAY CAUSE THE FURNITURE TO BE WOBBLY AND UNABLE TO SUPPORT ITS INTENDED WEIGHT CAPACITY. THIS MAY LEAD TO COLLAPSE AND MAY CAUSE SERIOUS INJURY.

ARM CHAIR



- Please keep instructions for future reference.
- Check the quantity and irregularity of parts and hardware before you start.



PARTS

(P1) - 2 PCS

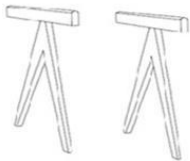

LEG FRAME-RIGHT

(P2) - 2 PCS

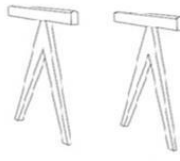

LEG FRAME-LEFT

(P3) - 4 PCS



SUPPORT RAIL

(P4) - 2 PCS

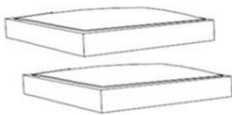

SEAT

(P5) - 2 PCS

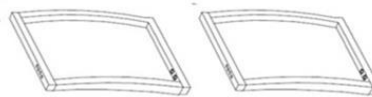

BACKREST

HARDWARE

(H1) - 16 PCS



M6x35mm JCBC SCREW

(H2) - 8 PCS



M6x50mm JCBC SCREW

(H3) - 24 PCS



Spring Washer

(H4) - 8 PCS



Flat Washer (BIG)

(H5) - 8 PCS



Flat Washer (SMALL)

(H6) - 16 PCS



Wood Dowel M10x30mm

HARDWARE

H7 - 16 PCS



Wood Dowel M8x30mm

H8 - 8 PCS



Wood Button

H9 - 1 PCS



Allen Key

H10 - 8 PCS



Nail Leg

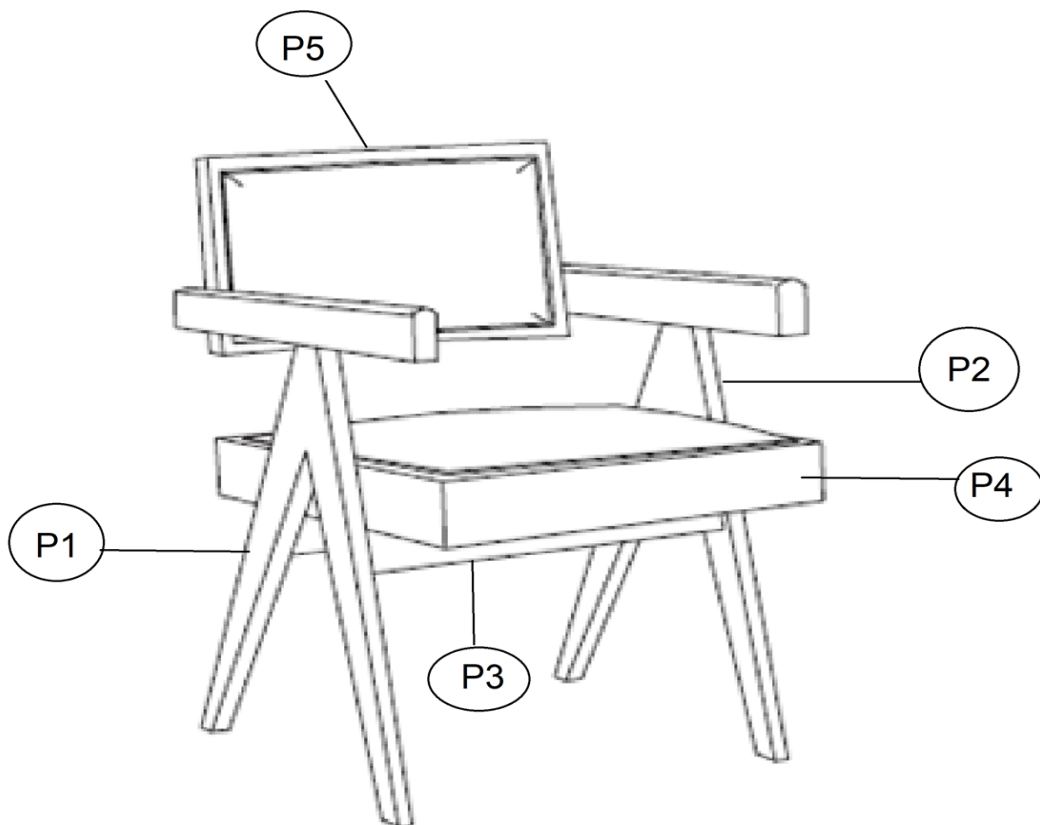

packed in 1 carton











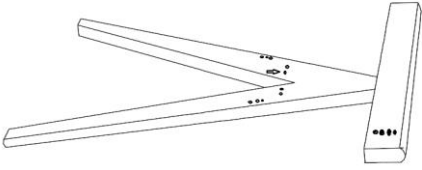

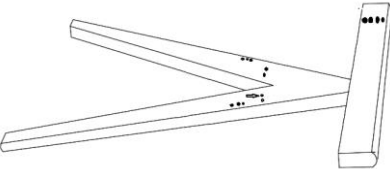

Please read instructions carefully

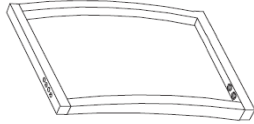
Remove all wrapping materials, staples and packing straps from the carton. Refer to Parts List and Hardware List and ensure they are complete before you start assembling. Place all wooden parts on a clean, flat and soft surface (e.g carpet or rug) to prevent parts from being scratched.

CAUTIONS: 1) DO NOT FULLY TIGHTEN BOLTS AND NUTS UNTIL ALL PARTS HAVE BEEN ASSEMBLED.

2) DO NOT OVER-TIGHTEN BOLTS AND NUTS .

3) KEEP ALL HARDWARE PARTS OUT OF REACH OF CHILDREN.

Carton	Designation	Part List	Hardware List
	LEG FRAME- P1	 P1 x 2pc	 H1 x 16pc
	LEG FRAME- P2	 P2 x 2pc	M6x35mm JCBC SCREW
	SUPPORT RAIL	 P3 x 4pc	 H2 x 8pc
	SEAT	 P4 x 2pc	M6x50mm JCBC SCREW
	BACKREST	 P5 x 2pc	 H3 x 24pc Spring Washer
			 H4 x 8pc Flat Washer(Big)
			 H5 x 8pc Flat Washer(Small)
			 H6 x 16pc Wood Dowel M10x30mm
			 H7 x 16pc Wood Dowel M8x30mm
			 H8 x 8pc Wood Button
			 H9 x 1pc Allen Key
			 H10 x 8pc Nail Leg

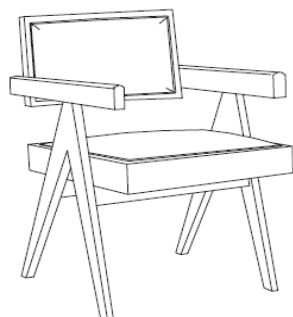

COMPLETE ASSEMBLY

ASSEMBLY INSTRUCTIONS

ARM CHAIR





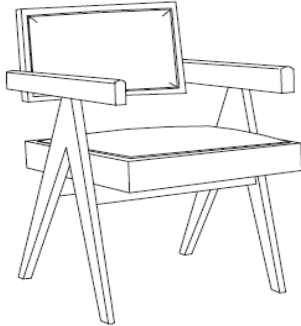





PARTS LIST (FOR 2 CHAIRS)

NO.	COMPONENT	QTY.
P1	LEG FRAME- P1	2
P2	LEG FRAME- P2	2
P3	SUPPORT RAIL	4
P4	SEAT	2
P5	BACKREST	2

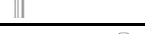

COMPLETE ASSEMBLY

HARDWARE LIST (FOR 2 CHAIRS)





NO.	DESCRIPTION	QTY.
H1	JCBC SCREW M6 x 35MM 	16
H2	JCBC SCREW M6 x 50MM 	8
H3	SPRING WASHER 	24
H4	FLAT WASHER (BIG) 	8
H5	FLAT WASHER (SMALL) 	8
H6	WOODEN DOWEL M10 x 30mm 	16
H7	WOODEN DOWEL M8 x 30mm 	16
H8	WOOD BUTTON 	8
H9	ALLEN KEY 	1
H10	NAIL LEG 	8

RUBBER Mallet IS NOT PROVIDED. 

SCREWDRIVER IS NOT PROVIDED. 

STEP 1

Prepare the Seat (P4) by inserting the Wooden dowel (H6) into the desired holes.

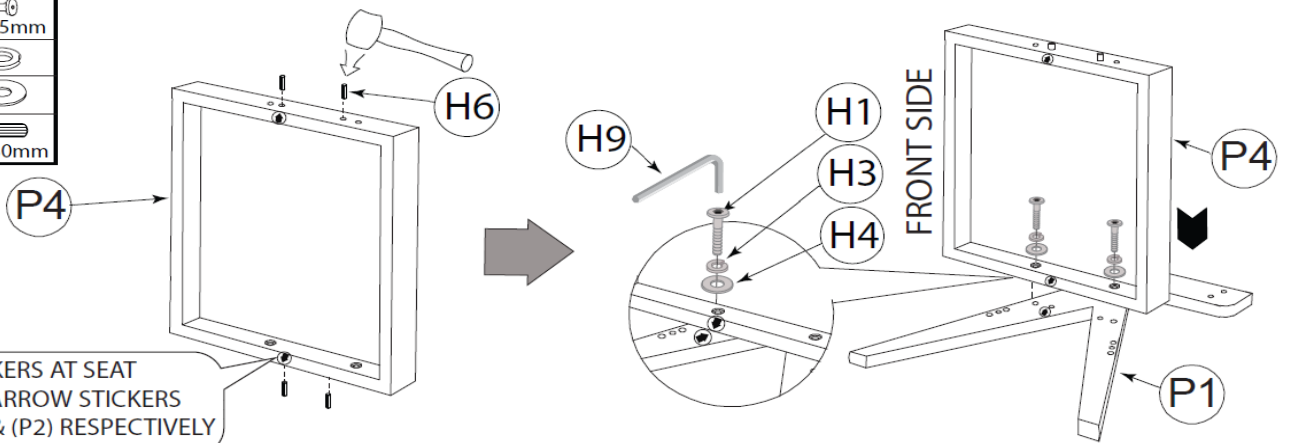

H1 x 2	 M6 x 35mm
H3 x 2	
H4 x 2	
H6 x 4	 M10 x 30mm



ARROW STICKERS AT SEAT MUST MEET ARROW STICKERS IN LEGS (P1) & (P2) RESPECTIVELY

Attach the Seat (P4) to the Leg frame by locating the dowels into the desired holes in the Leg (P1). Match the ARROW stickers to ensure the seat is in the correct position. Then, align Screw (H1) with Spring washer (H3) & Flat washer Big (H4) tighten it using Allen key (H9).

STEP 2



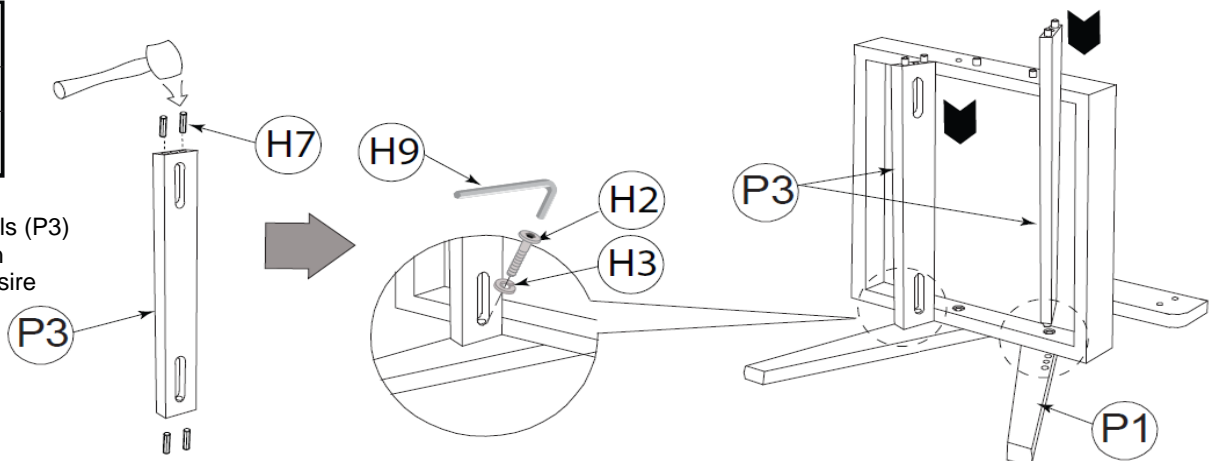

H2 x 2	 M6 x 50mm
H3 x 2	
H7 x 8	 M8 x 30mm

Prepare the Support rails (P3) by inserting the wooden dowels (H7) into the desired holes.



Assemble both Support rails (P3) into the desired holes in the Leg frame. Align Bolt (H2) with Spring Washer (H3) & tighten it using Allen key (H9).

STEP 3

H1 x 2	 M6 x 35mm
H3 x 2	
H5 x 2	
H6 x 4	 M10 x 30mm
H8 x 2	

Prepare the Backrest (P5) by inserting the Wood dowel (H6) into the desired holes at the backrest. Then, attach the Backrest (P5) by locating the wood dowel at the backrest into the desired holes at the armrest. Align Bolt (H1) together with the Spring washer (H3) & Flat washer Small (H5). Tighten it using Allen key (H9).

Tap the Wood button (H8) to cover the holes.

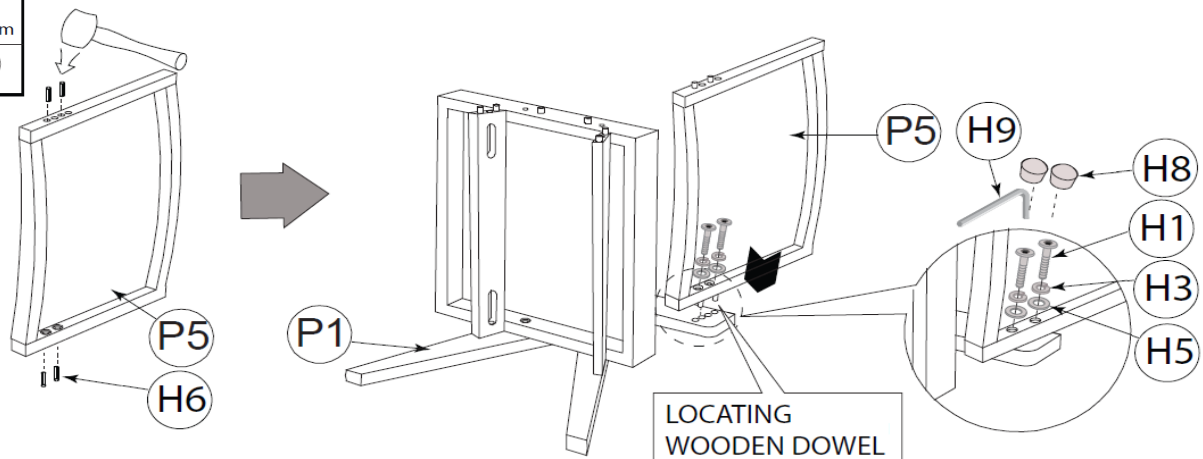

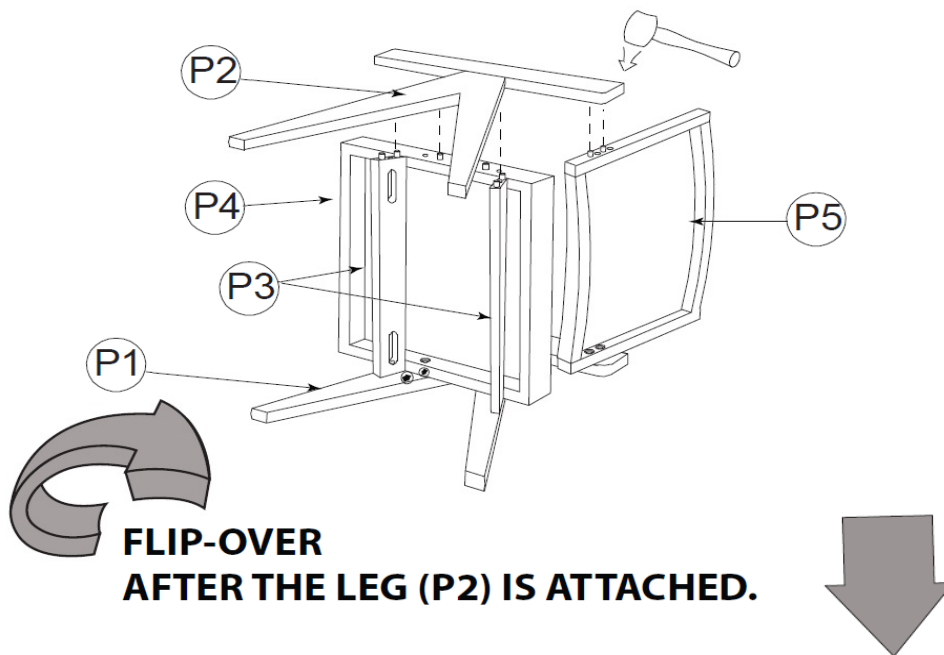

STEP 4

Prepare the other side of the leg: the Leg frame-Left (P2). Attach it to the parts of (Seat P4), Support rail (P3) & Backrest (P5), by locating the wood dowel at those parts to the desired holes in the Leg (P2). Use a rubber mallet to tap the leg frame until all the parts are snug to the leg frame. Then, carefully flip the chair to the other side to secure remaining holes with corresponding bolts.



STEP 5

H1 x 2	 M6 x 35mm
H3 x 2	
H4 x 2	

FITTING TO THE SEAT

Start with fitting the leg to the seat by aligning Screw (H1) with Spring washer (H3) & Flat washer Big (H4). Tighten it using Allen key (H9).

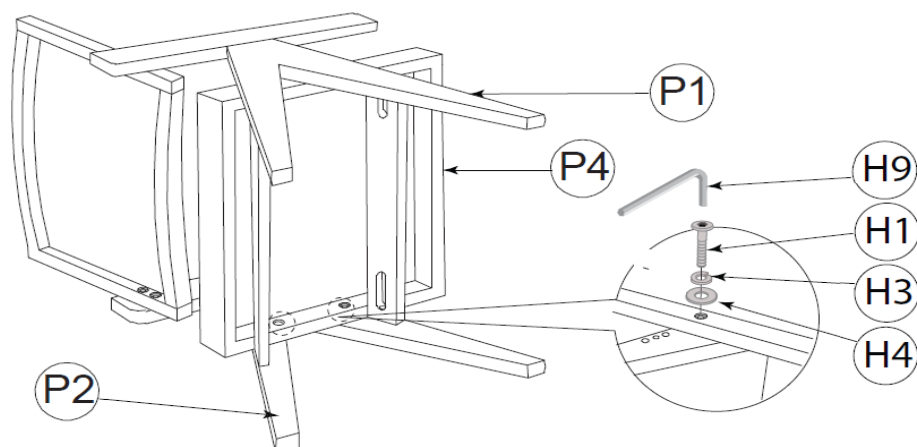

STEP 6

H2 x 2

M6 x 50mm

H3 x 2



FITTING TO THE SUPPORT RAILS

Continue with fitting to the Support rails (P3), by Aligning Bolt (H2) with Spring Washer (H3) & tighten it using Allen key (H9).

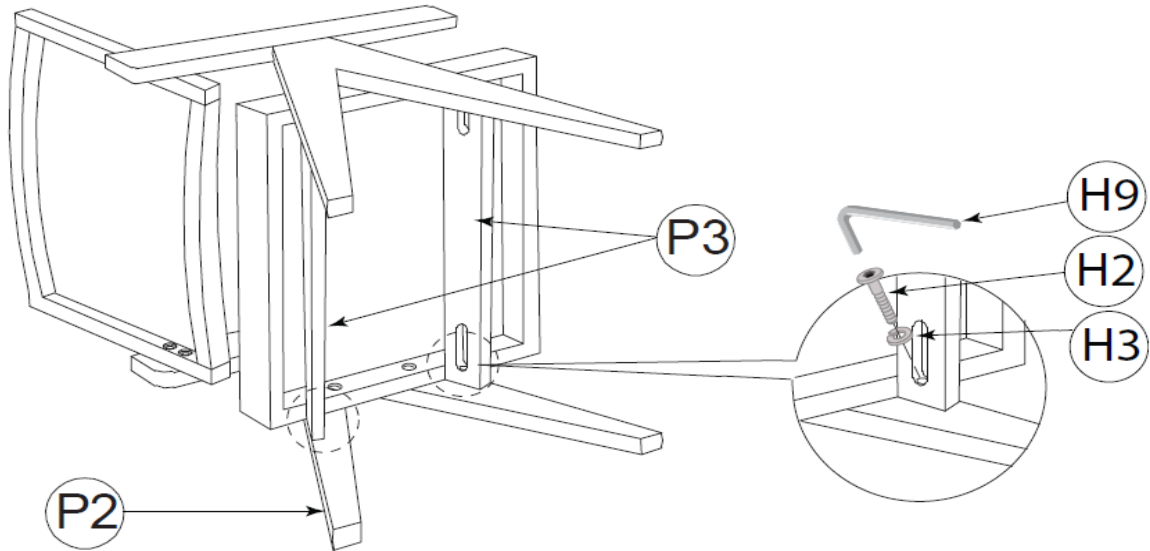

STEP 7

H1 x 2

M6 x 35mm

H3 x 2



H5 x 2



H8 x 2



FITTING TO THE BACKREST

Lastly, fit the armrest to the backrest by Aligning Bolt (H1) together with the Spring washer (H3) & Flat washer Small (H5). Tighten it using Allen Key (H9). Tap the Wood button (H8) to cover the holes.

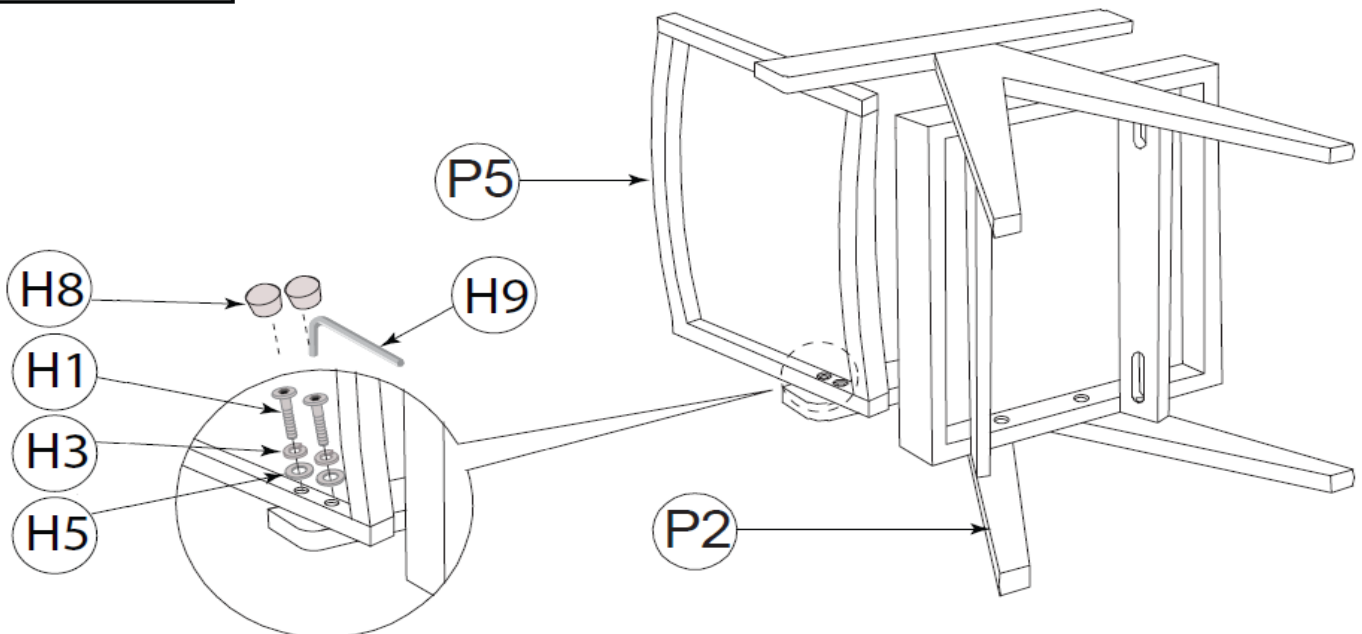

PLEASE MAKE SURE ALL THE BOLTS ARE FULLY TIGHTEN BEFORE USING THE CHAIR

STEP 8

H10 x 4



Before putting the chair upright , tap the Nail leg (H10) into the under edge of all the legs .

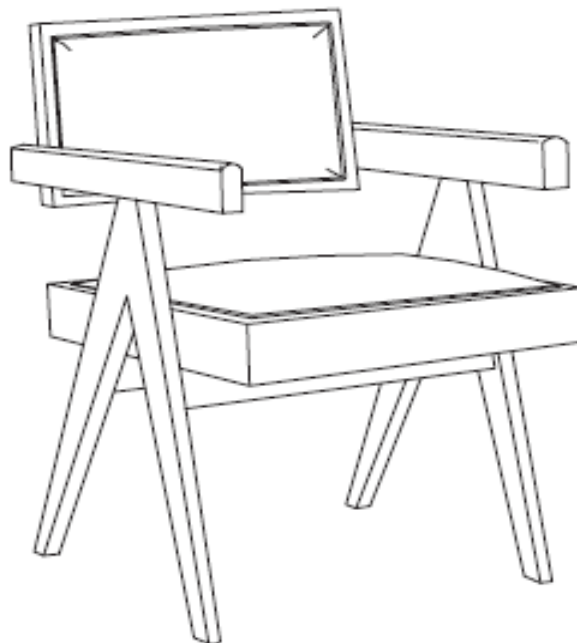
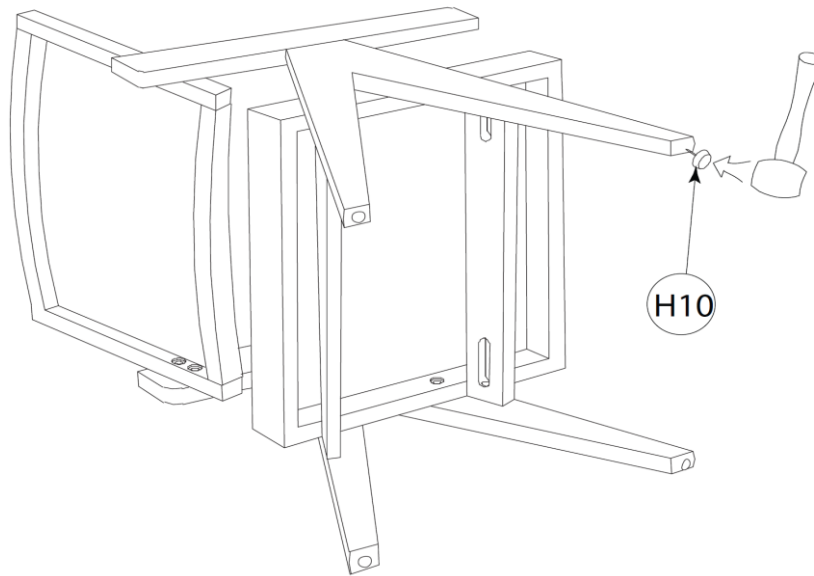

PLEASE MAKE SURE ALL THE BOLTS ARE FULLY TIGHTEN BEFORE USING THE CHAIR

CARE AND MAINTENANCE

SAFETY - To avoid any risk of suffocation to children or animals, dispose off the plastic bags immediately.

CLEANING - Clean with damp cloth and mild detergent. Do not use bleach or abrasive products.

FITTINGS - Tighten bolts and nuts from time to time to ensure all parts of product are securely fitted.

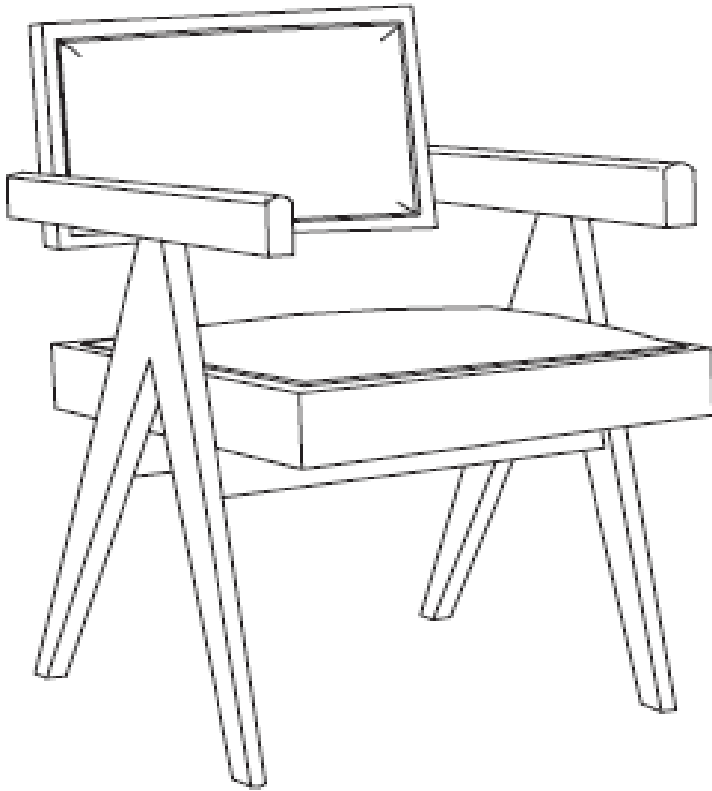

ASSEMBLY COMPLETED



Please ensure the furniture rests on an even and flat surface. If the product wobbles or feels loose, double-check all bolts and/or screws are properly tightened and secured.



Keep this handy!

Please retain this instruction manual and any order-related information for future reference.



Lift, don't drag!

To avoid damage to product please always LIFT the product when transporting or adjusting the placement.

This product is intended for RESIDENTIAL USE ONLY and not for commercial use .

CARE AND MAINTENANCE

SAFETY - To avoid any risk of suffocation to children or animals, dispose off the plastic bags immediately.

CLEANING - Clean with damp cloth and mild detergent. Do not use bleach or abrasive products.

FITTINGS - Tighten bolts and nuts from time to time to ensure all parts of product are securely fitted.